

SPECIFICATIONS

CUSTOMER	:	_____
SAMPLE CODE	:	SH102600T009-IBC03
MASS PRODUCTION CODE	:	PH102600T009-IBC03
SAMPLE VERSION	:	01
SPECIFICATIONS EDITION	:	005
DRAWING NO. (Ver.)	:	LMD-PH102600T009-IBC03 (Ver.002)
PACKAGING NO. (Ver.)	:	PKG-PH102600T009-IBC03 (Ver.002)

Customer Approved

Date: _____

Approved	Checked	Designer
林裘中 Daniel Lin	廖志豪 Rex Liao	張慶源 Yuan Chang

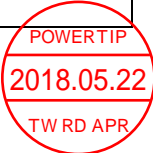

- Preliminary specification for design input
- Specification for sample approval

POWERTIP TECH. CORP.

Headquarters:

No.8, 6th Road, Taichung Industrial Park,
Taichung, Taiwan
台中市 407 工業區六路 8 號

TEL: 886-4-2355-8168
FAX: 886-4-2355-8166

E-mail: sales@powertip.com.tw
Http://www.powertip.com.tw

Contents

1. SPECIFICATIONS

- 1.1 Features
- 1.2 Mechanical Specifications
- 1.3 Absolute Maximum Ratings
- 1.4 DC Electrical Characteristics
- 1.5 Optical Characteristics
- 1.6 Backlight Characteristics
- 1.7 Touch Panel Characteristics

2. MODULE STRUCTURE

- 2.1 Counter Drawing
- 2.2 Interface Pin Description
- 2.3 Timing Characteristics
- 2.4 AC Electrical Characteristics
- 2.5 Timing

3. QUALITY ASSURANCE SYSTEM

- 3.1 Quality Assurance Flow Chart
- 3.2 Inspection Specification

4. RELIABILITY TEST

- 4.1 Reliability Test Condition

5. PRECAUTION RELATING PRODUCT HANDLING

- 5.1 Safety
- 5.2 Handling
- 5.3 Storage
- 5.4 Terms of Warranty

Appendix :

- a. LCM Drawing
- b. LCM Packaging Specifications

1. SPECIFICATIONS

1.1 Features

Item	Standard Value
Display Type	1024 * 3 (RGB) * 600 Dots
LCD Type	a-Si TFT , Normally white , Transmissive type
Gray Scale Inversion Direction	6 o'clock
Eyes Viewing Direction	12 o'clock
Screen size(inch)	7.0 inch
Color configuration	RGB-Strip
Backlight Type	LED B/L
Interface	LVDS Interface
Other(controller/driver IC)	NT51008+NT52003 (Or Compatible IC)
ROHS	THIS PRODUCT CONFORMS THE ROHS OF PTC Detail information please refer website : http://www.powertip.com.tw/news_detail.php?Key=1&cID=1

1.2 Mechanical Specifications

Item	Standard Value	Unit
Outline Dimension	192.96(W) * 121.4(L) * 4.58(H)	mm

LCD panel

Item	Standard Value	Unit
Viewing Area	155.01(W) x 86.92 (L)	mm
Active Area	154.21 (W) * 85.92 (L)	mm

Note : For detailed information please refer to LCM drawing

1.3 Absolute Maximum Ratings

Module

Item	Symbol	Condition	Min.	Max.	Unit
Power Voltage	DV _{DD}	-	-0.5	5	V
	V _{DD}	-	-0.5	15	V
	V _{GH}	-	-0.3	42	V
	V _{GL}	-	-20	0.3	V
Operating Temperature	T _{OP}	-	-20	70	°C
Storage Temperature	T _{ST}	-	-30	80	°C

1.4 DC Electrical Characteristics

Module

GND = 0V, Ta = 25 °C

Item	Symbol	Condition	Min.	Typ.	Max.	Unit	Remark
	V _{DD}	-	2.5	3.3	3.6	V	
	AV _{DD}	-	8	11	13.5	V	
	V _{GH}	-	19.7	20	20.3	V	
	V _{GL}	-	-7.1	-6.8	-6.5	V	
Input signal Voltage	V _{COM}	-	3.3	3.8	4.3	V	
Input Signal Voltage	V _{IH}	-	0.7V _{DD}	-	V _{DD}	V	
	V _{IL}	-	0	-	0.3 V _{DD}	V	
Supply Current	I _{DD}	V _{DD} = 3.3 V Pattern= Red	-	40	60	mA	Note1
	I _{ADD}	AV _{DD} =11.0V Pattern= Red	-	25	45	mA	
	I _{GH}	V _{GH} =20V Pattern= Red	-	0.3	0.5	mA	
	I _{GL}	V _{GL} =-6.8V Pattern= Red	-	0.3	0.5	mA	
	I _{Vcom}	V _{COM} =3.8V Pattern= Red	-	8	15	uA	

Note1:Maximum current display

1.5 Optical Characteristics

TFT LCD Module

VDD = 3.3 V, Ta=25°C

Item	Symbol	Condition	Min.	Typ.	Max.	unit		
Response time	Tr + Tf	Ta = 25°C θX, θY = 0°	-	30	45	ms	Note 2	
Viewing angle	Top	θY+	CR ≥ 10	-	60	-	Deg.	Note 4
	Bottom	θY-		-	60	-		
	Left	θX-		-	60	-		
	Right	θX+		-	60	-		
Contrast ratio	CR		500	600	-	-	Note 3	
Color of CIE Coordinate (With B/L)	White	X	Ta = 25°C θX , θY = 0°	0.23	0.28	0.33	-	Note1
		Y		0.29	0.34	0.39		
	Red	X		0.62	0.67	0.72		
		Y		0.27	0.32	0.37		
	Green	X		0.27	0.32	0.37		
		Y		0.55	0.60	0.65		
	Blue	X		0.09	0.14	0.19		
		Y		0.01	0.04	0.09		
Average Brightness Pattern=white display (With LCD)*1	IV	IF=200 mA	310	330	-	cd/m ²	Note1	
Uniformity (With LCD)*2	ΔB	IF=200 mA	70	-	-	%	Note1	

Note 1:

*1 : $\Delta B = B(\min) / B(\max) * 100\%$

*2 : Measurement Condition for Optical Characteristics:

a : Environment: $25^{\circ}\text{C} \pm 5^{\circ}\text{C}$ / $60 \pm 20\% \text{R.H}$, no wind , dark room below 10 Lux at typical lamp current and typical operating frequency.

b : Measurement Distance: 500 ± 50 mm , ($\theta = 0^{\circ}$)

c : Equipment: TOPCON BM-7 fast , (field 1°) , after 10 minutes operation.

d : The uncertainty of the C.I.E coordinate measurement ± 0.01 , Average Brightness $\pm 4\%$

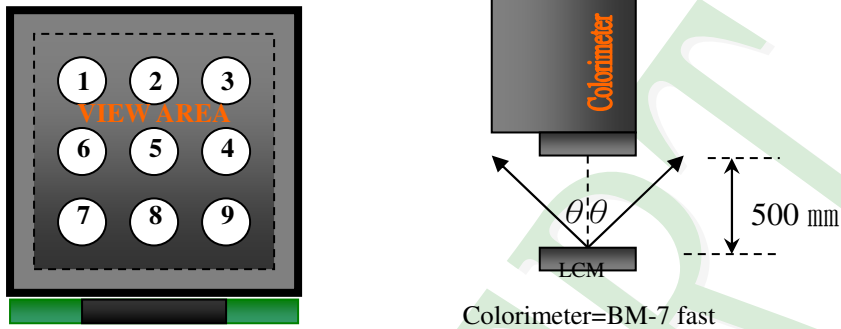

To be measured at the center area of panel with a viewing cone of 1° by Topcon luminance meter BM-7, after 10 minutes operation (module)

Note2: Definition of response time:

The output signals of photo detector are measured when the input signals are changed from "black" to "white"(falling time) and from "white" to "black"(rising time), respectively. The response time is defined as the time interval between the 10% and 90% of Amplitudes.

Refer to figure as below:

Normally White



Normally Black

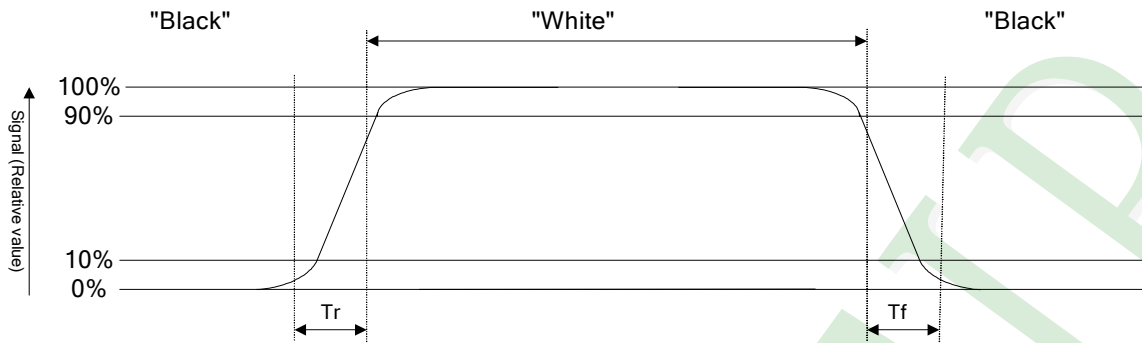

Note3: Definition of contrast ratio:

Contrast ratio is calculated with the following formula

$$\text{Contrast ratio (CR)} = \frac{\text{Photo detector output when LCD is at "White" state}}{\text{Photo detector output when LCD is at "Black" state}}$$

Note4: Definition of viewing angle:

Refer to figure as below:

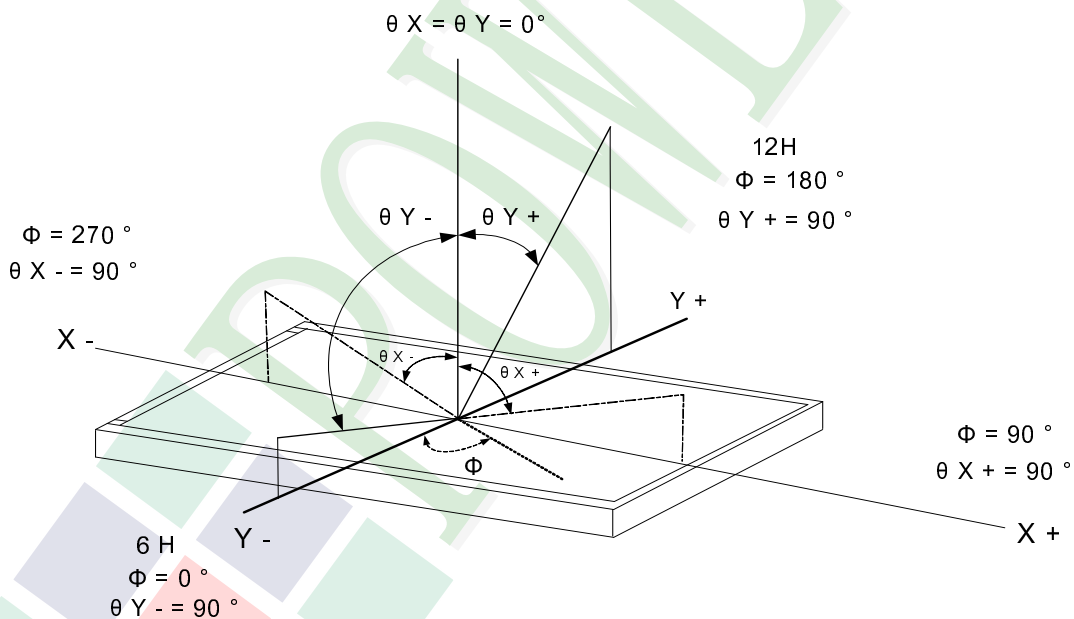

Note5: Applying with spectrophotometer in the condition of 400 to 700nm, 10nm/each; in accordance with JIS Z 8701 2 degree viewing XYZ system, measuring the reflective rate of 5 degree

1.6 Backlight Characteristics

Maximum Ratings

Item	Symbol	Conditions	Min.	Max.	Unit
LED Forward Current	IF	Ta =25℃	-	300	mA
LED Reverse Voltage	VR	Ta =25℃	-	5	V
Power Dissipation	PD	Ta =25℃	-	2040	W

Backlight Characteristics

Item	Symbol	Conditions	Min.	Typ.	Max.	Unit
Forward Voltage	VF	IF=200mA	9.0	9.6	10.2	V
Average Brightness (Without LCD)	IV		12500	13200	-	cd/m ²
CIE Color Coordinate (Without LCD)	X		0.25	0.28	0.31	-
	Y		0.28	0.31	0.34	
Uniformity *1	△B		80	-	-	*2
Color		White				

*1 : This value will be changed while mass production.

*2 : $\Delta B = B(\min) / B(\max)\%$

B/L Internal Circuit Diagram

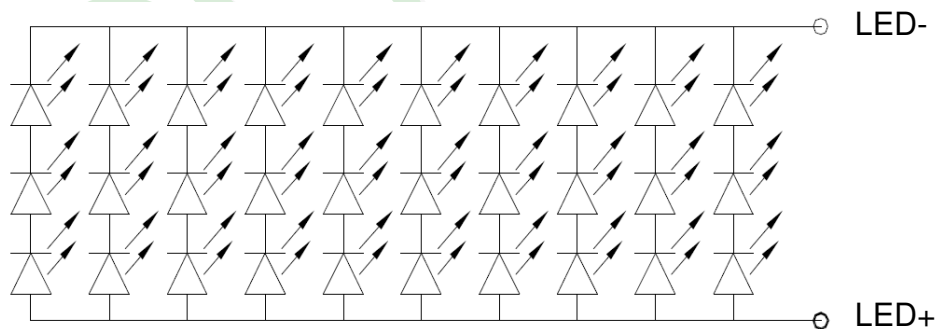

Other Description

Item	Conditions	Description
Life Time	Ta =25℃ IF=200 mA	20000 hrs

1.7 Touch Panel Characteristics

Features

Item	Standard Value
Touch Panel Size	7.0"
Touch type	Capacitive Touch Panel
Input Method	True Multi-Touch Capacitive Touch Panel True Multi-touch with up to 5 Points of Absolution
Output Interface	I ² C
IC	FT5426

I²C Address

Bit 7	Bit 6	Bit 5	Bit 4	Bit 3	Bit 2	Bit 1	Bit 0
0	1	1	1	0	0	0	R/W

Bit 0: 0 for Write / 1 for Read

Mechanical Specifications

Item	Standard Value	Unit
Viewing Area	155.01 (W) * 86.92 (L)	mm

DC Electrical Characteristics

Item	Symbol	Condition	Min.	Typ.	Max.	Unit
LCM driving voltage	V _{DD}	25°C	-	3.3	-	V
Input Signal Voltage	V _{IH}		0.85 x V _{DD}	-	-	V
	V _{IL}		-	-	0.15 x V _{DD}	V

Optical Characteristics

Item	Standard Value	Unit
Response Time	≤25ms	
Total light transmittance	85% or more	-
Surface Hardness	≥7H	-

2. MODULE STRUCTURE

2.1 Counter Drawing

2.1.1 LCM Mechanical Diagram

* See Appendix

2.1.2 Block Diagram

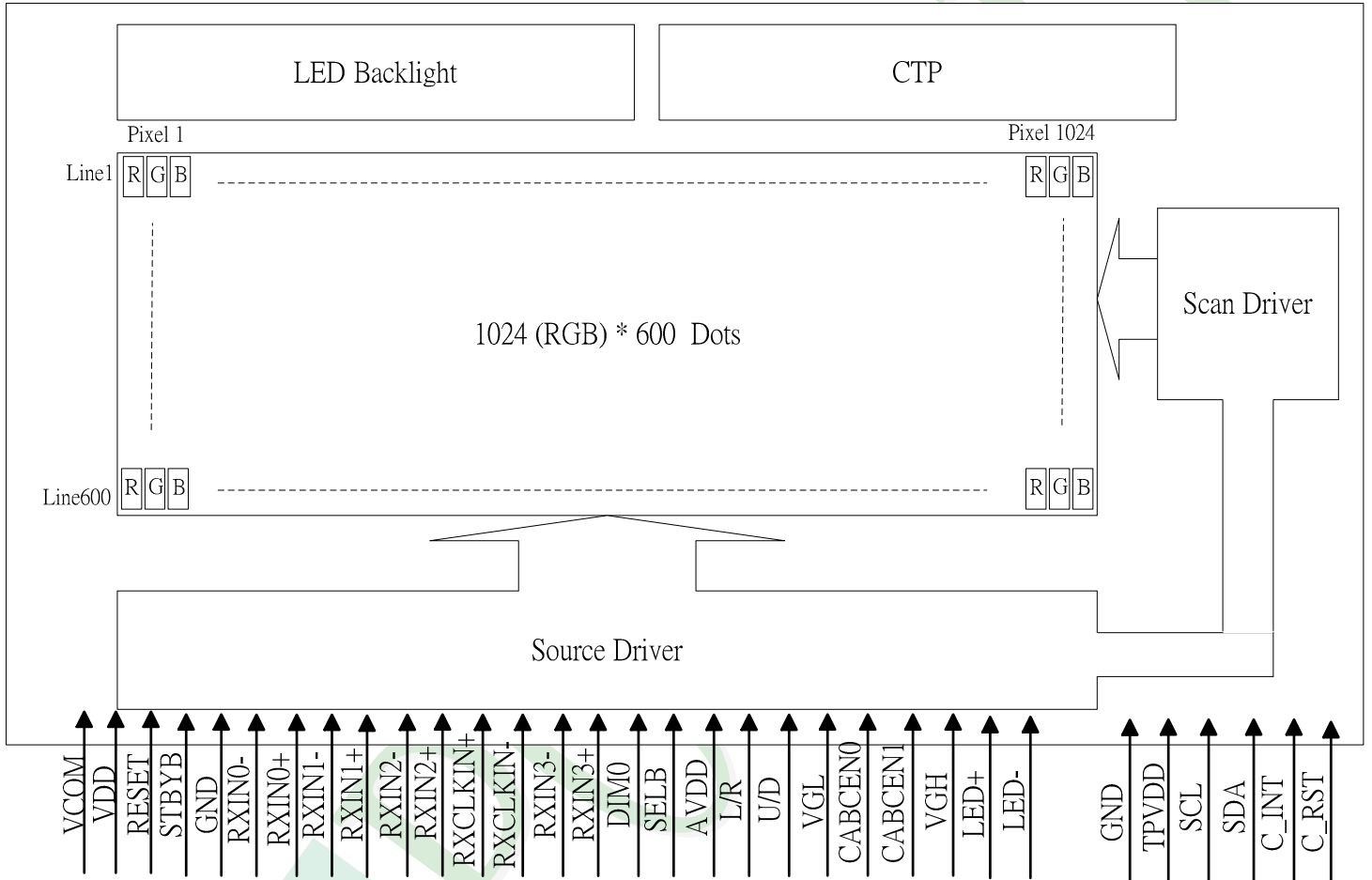

2.2 Interface Pin Description

Pin No.	Symbol	Function
1	VCOM	Common Voltage
2	VDD	Power Voltage for digital circuit
3	VDD	Power Voltage for digital circuit
4	NC	No connection
5	Reset	Global reset pin
6	STBYB	Standby mode, Normally pulled high STBYB = “1” , normal operation STBYB = “0” , timing controller, source driver will turn off, all output are High-Z
7	GND	Ground
8	RXIN0-	- LVDS differential data input
9	RXIN0+	+ LVDS differential data input
10	GND	Ground
11	RXIN1-	- LVDS differential data input
12	RXIN1+	+ LVDS differential data input
13	GND	Ground
14	RXIN2-	- LVDS differential data input
15	RXIN2+	+ LVDS differential data input
16	GND	Ground
17	RXCLKIN-	- LVDS differential clock input
18	RXCLKIN+	+ LVDS differential clock input
19	GND	Ground
20	RXIN3-	- LVDS differential data input
21	RXIN3+	+ LVDS differential data input
22	GND	Ground
23	NC	No Connection
24	NC	No Connection
25	GND	Ground

Pin No.	Symbol	Function
26	NC	No Connection
27	DIM0	Backlight CABC controller signal output DIM0=L Turn off external backlight controller DIM0=H Logical control signal to turn on external backlight controller
28	SELB	6bit/8bit mode select If LVDS input data is 6 bits ,SELB must be set to High; If LVDS input data is 8 bits ,SELB must be set to Low.
29	AVDD	Power for Analog Circuit
30	GND	Ground
31	LED-	LED Cathode
32	LED-	LED Cathode
33	L/R	Horizontal inversion When L/R="0", set right to left scan direction. When L/R="1", set left to right scan direction.
34	U/D	Vertical inversion When U/D="0", set top to bottom scan direction. When U/D="1", set bottom to top scan direction.
35	VGL	Gate OFF Voltage
36	CABCEN1	CABC H/W enable Note:1
37	CABCEN0	CABC H/W enable Note:1
38	VGH	Gate ON Voltage
39	LED+	LED Anode
40	LED+	LED Anode

Note1:

CABCEN1	CABCEN0	DESCRIPTION
L	L	CABC OFF
L	H	User interface Image
H	L	Still Picture
H	H	Moving Image

Capacitive Touch Panel (CTP) Interface

Pin No.	Symbol	Function
1	GND	Ground.
2	TPVDD	Power.
3	SCL	I ² C Clock.
4	SDA	I ² C Data.
5	C_INT	The interrupt from the CTP to the Host H: CTP interrupt not requested L: CTP request interrupt
6	C_RST	RESET.

2.3 Timing Characteristics

2.3.1 Power Sequence

In order to prevent IC from power on reset fail, the rising time (T_{POR}) of the digital power supply VDD should be maintained within the given specifications. Refer to "AC Characteristics" for more detail on timing.

Power-On/Off Timing Sequence:

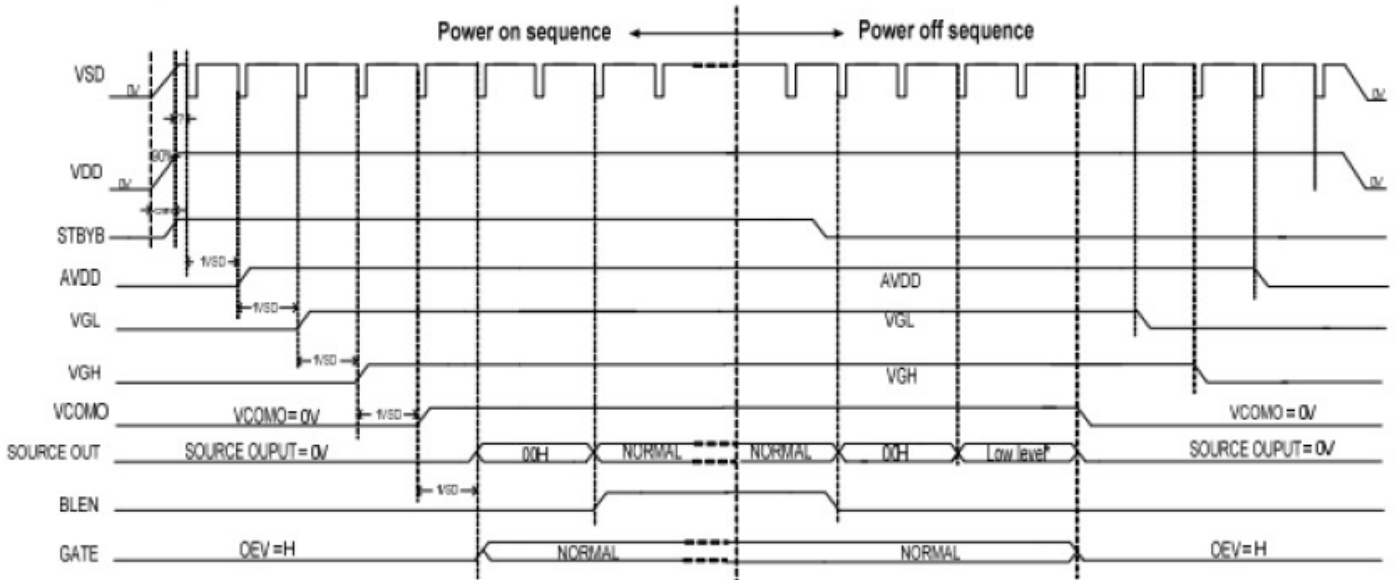

Enter and Exit Standby Mode Sequence:

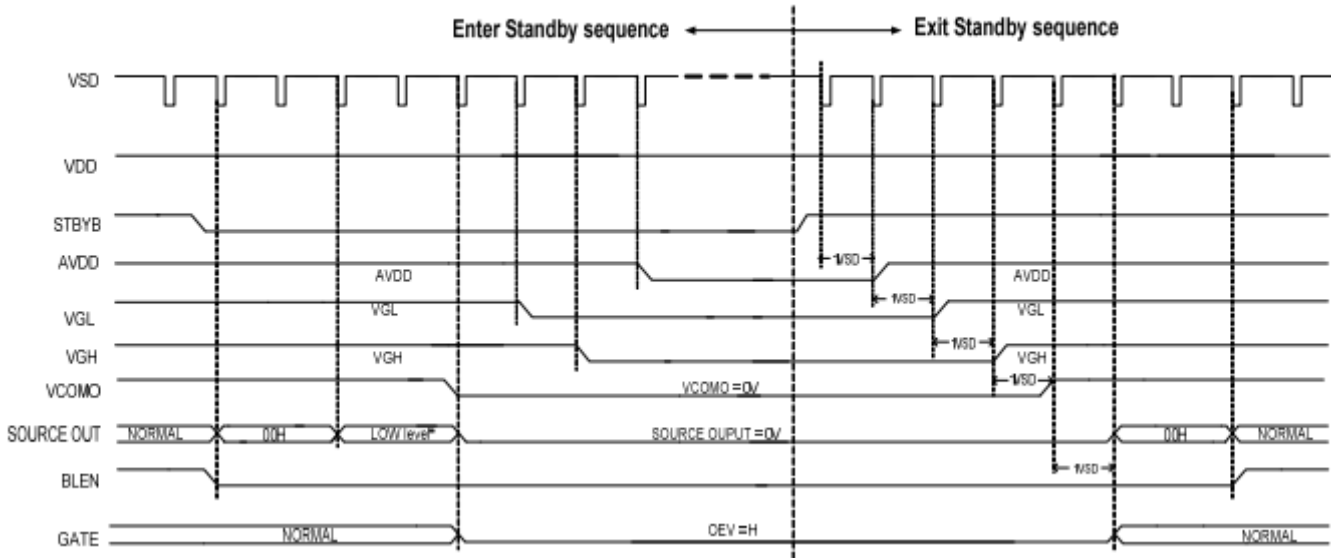

2.3.2 Data Input Format for LVDS

6bit LVDS input

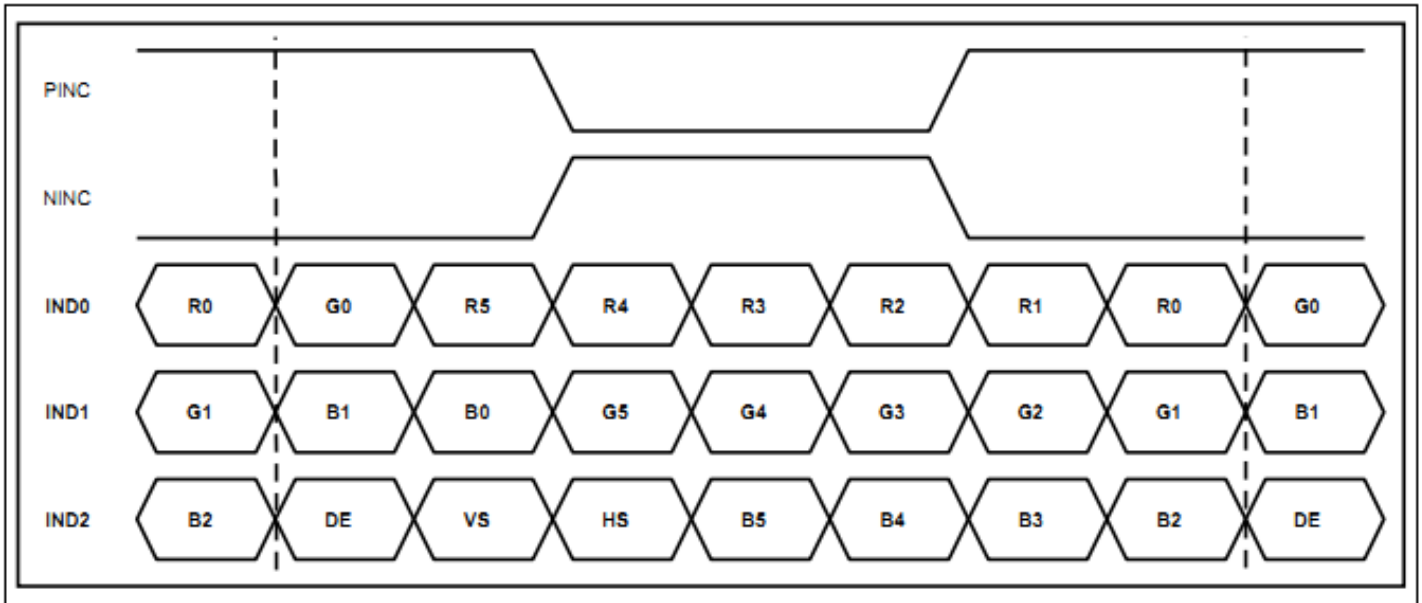

8-bit LVDS input (HSD='L')

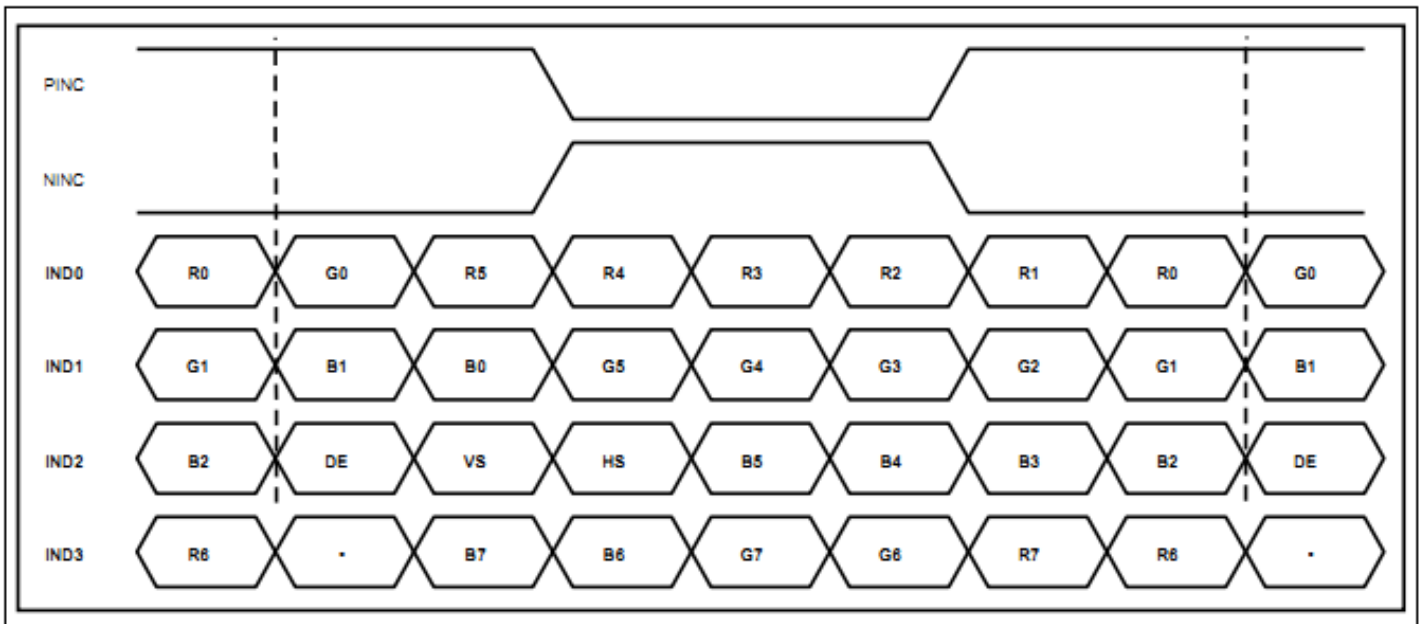

2.4 AC Electrical Characteristics

LVDS mode

Parameter	Symbol	Min.	Typ.	Max.	Unit	Condition
Clock frequency	R_{xFCLK}	20		71	MHz	
Input data skew margin	T_{RSKM}	500			pS	$ V_{ID} = 400\text{mV}$ $R_{xVCM} = 1.2\text{V}$ $R_{xFCLK} = 71\text{MHz}$
Clock high time	T_{LVCH}		$4/(7 * R_{xFCLK})$		ns	
Clock low time	T_{LVCL}		$3/(7 * R_{xFCLK})$		ns	
PLL wake-up time	T_{enPLL}			150	uS	

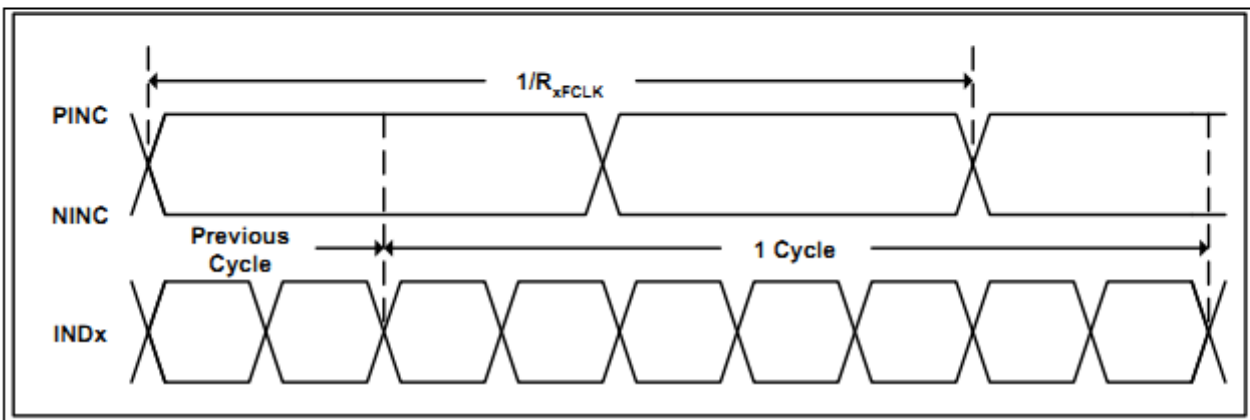

2.5 Timing

SDRRS (seamless display refresh rate switching)

When Showing the still picture, it is accept to reduce the refresh rate from 60Hz to low refresh rate (for example 40Hz). The purpose is mainly for power saving. INTEL defined a timing chart switch between different refresh rate. Following this timing chart, the switch between different refresh rates is seamless for end user.

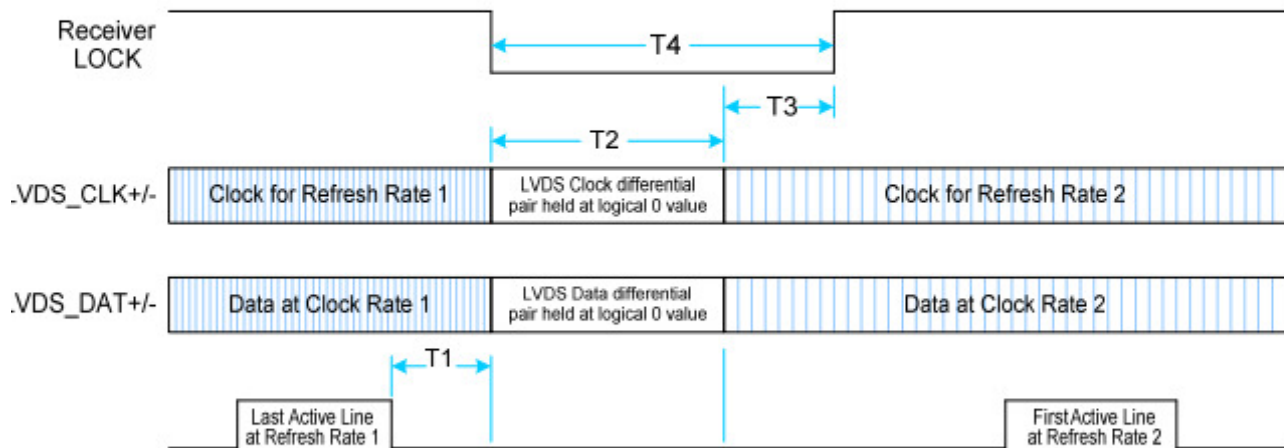

- T1 - Min delay from start of vert blank to start of timing change: 2 lines (HSYNC periods)
- T2 - Max delay for clock to transition to new frequency: 100us
- T3 - Max receiver lock delay from stable clock: Display specific (TBD)
- T4 - Max period during which panel maintains display (T2+T3): Display specific (TBD)

3. QUALITY ASSURANCE SYSTEM

3.1 Quality Assurance Flow Chart

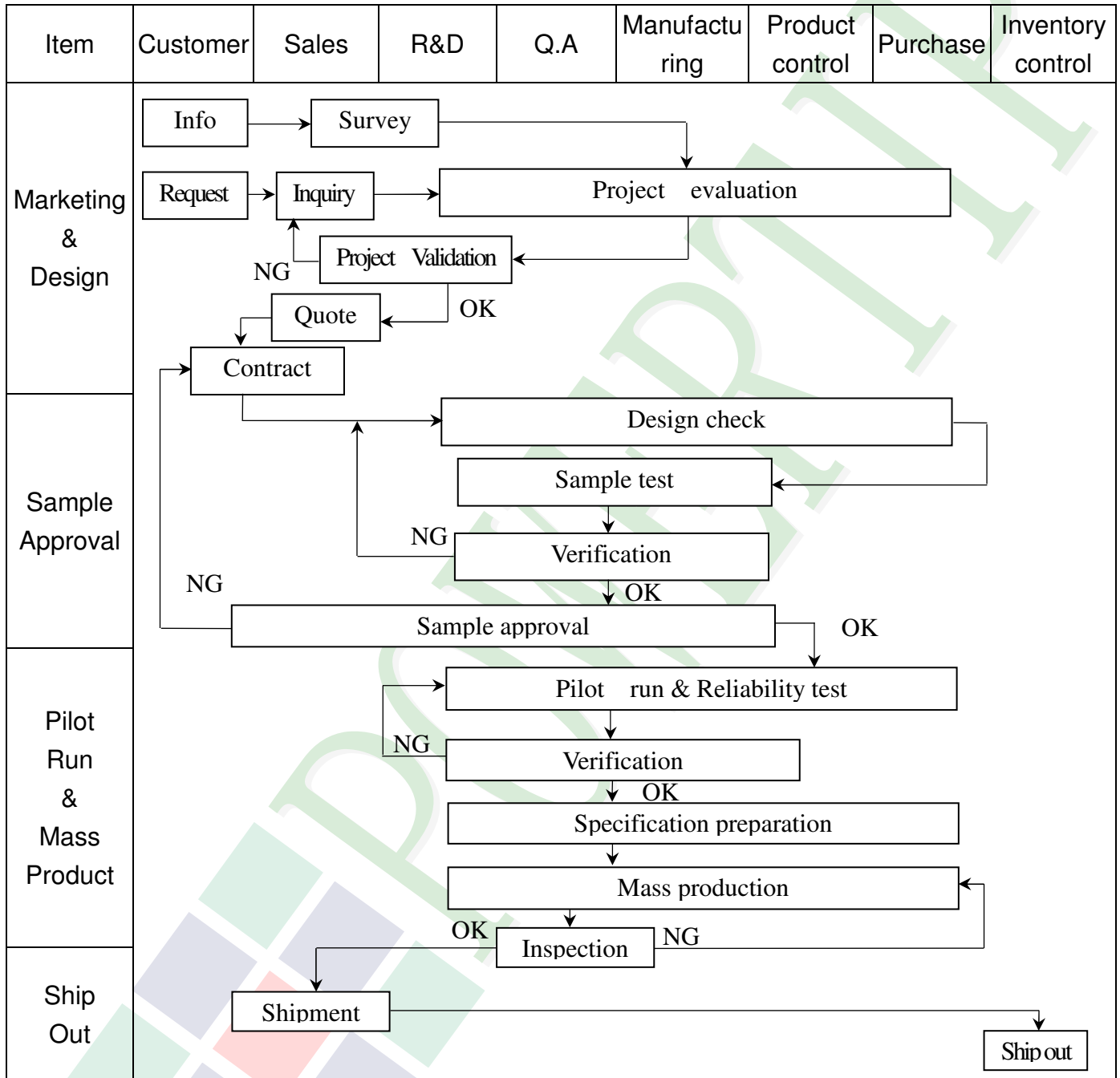

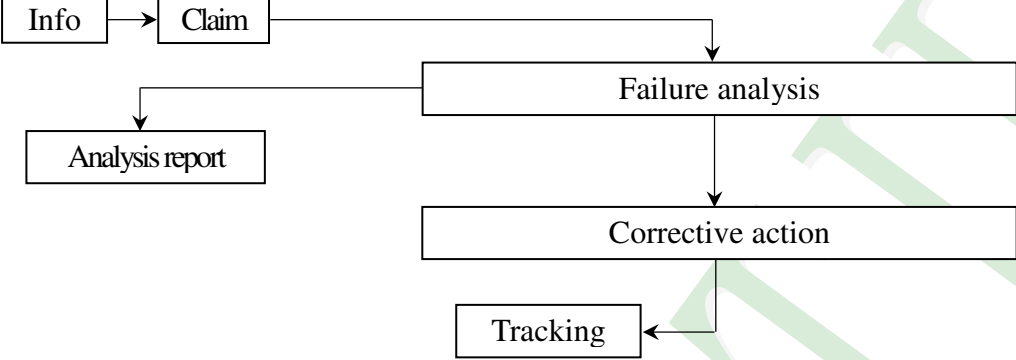
Item	Customer	Sales	R&D	Q.A	Manufacturing	Product control	Purchase	Inventory control
Sales Service	 <pre> graph TD Info[Info] --> Claim[Claim] Claim --> Failure[Failure analysis] Failure --> Report[Analysis report] Failure --> Action[Corrective action] Action --> Tracking[Tracking] </pre>							
Q.A Activity	1. ISO 9001 Maintenance Activities 3. Equipment calibration 5. Standardization Management				2. Process improvement proposal 4. Education And Training Activities			

3.2. Inspection Specification

◆Scope : The document shall be applied to TFT-LCD Module for 3.5" ~15" (Ver.B01).

◆Inspection Standard : MIL-STD-105E Table Normal Inspection Single Sampling Level II.

◆Equipment : Gauge 、 MIL-STD 、 Powertip Tester 、 Sample

◆Defect Level : Major Defect AQL : 0.4 ; Minor Defect AQL : 1.5

◆OUT Going Defect Level : Sampling.

◆Standard of the product appearance test :

a. Manner of appearance test :

(1). The test best be under 20W×2 fluorescent light , and distance of view must be at 30 cm.

(2). The test direction is base on about around 45° of vertical line.

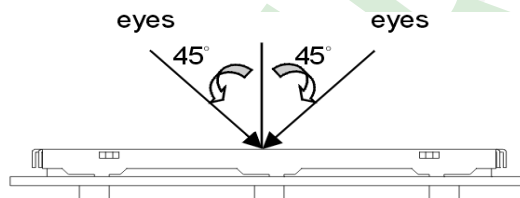

(3). Definition of area.

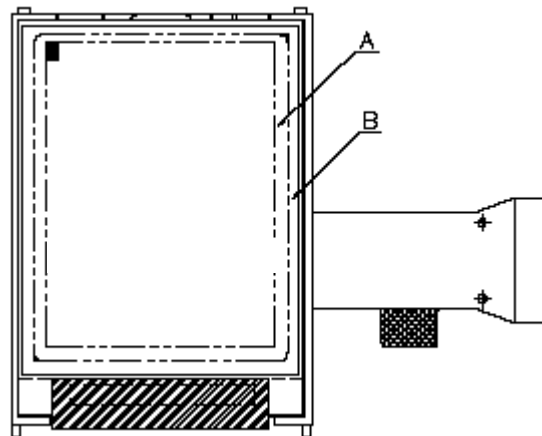

A area : viewing area

B area : Outside of viewing area

(4). Standard of inspection : (Unit : mm)

◆Specification For TFT-LCD Module 3.5" ~15" :
(Ver.B01)

NO	Item	Criterion	Level												
01	Product condition	1. 1 The part number is inconsistent with work order of production.	Major												
		1. 2 Mixed product types.	Major												
		1. 3 Assembled in inverse direction.	Major												
02	Quantity	2. 1 The quantity is inconsistent with work order of production.	Major												
03	Outline dimension	3. 1 Product dimension and structure must conform to structure diagram.	Major												
04	Electrical Testing	4. 1 Missing line character and icon.	Major												
		4. 2 No function or no display.	Major												
		4. 3 Display malfunction.	Major												
		4. 4 LCD viewing angle defect.	Major												
		4. 5 Current consumption exceeds product specifications.	Major												
		4. 6 Mura can not be seen through 5% ND filter. (Mura : Under the normal examination angle of view, the picture has the non-uniform phenomenon.)	Minor												
05	Dot defect (Bright dot 、 Dark dot) On -display	<table border="1" style="margin-left: auto; margin-right: auto;"> <thead> <tr> <th colspan="2">Item</th> <th>Acceptance (Q'ty)</th> </tr> </thead> <tbody> <tr> <td rowspan="4" style="text-align: center; vertical-align: middle;">Dot Defect</td> <td style="text-align: center;">Bright Dot</td> <td style="text-align: center;">≤ 4</td> </tr> <tr> <td style="text-align: center;">Dark Dot</td> <td style="text-align: center;">≤ 5</td> </tr> <tr> <td style="text-align: center;">Joint Dot</td> <td style="text-align: center;">≤ 3</td> </tr> <tr> <td style="text-align: center;">Total</td> <td style="text-align: center;">≤ 7</td> </tr> </tbody> </table>	Item		Acceptance (Q'ty)	Dot Defect	Bright Dot	≤ 4	Dark Dot	≤ 5	Joint Dot	≤ 3	Total	≤ 7	Minor
		Item		Acceptance (Q'ty)											
		Dot Defect	Bright Dot	≤ 4											
			Dark Dot	≤ 5											
			Joint Dot	≤ 3											
Total	≤ 7														
5. 1 Inspection pattern : full white , full black , Red , Green and blue screens.															
5. 2 It is defined as dot defect if defect area $> 1/2$ dot.															
5. 3 The distance between two dot defect ≥ 5 mm.															
5. 4 Bright dot that can not be seen through 5% ND filter.															

◆Specification For TFT-LCD Module 3.5" ~15" :

(Ver.B01)

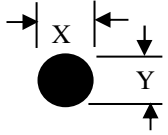
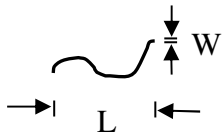
NO	Item	Criterion	Level																																										
06	Black or white dot、scratch、contamination Round type  $\Phi = (x + y) / 2$ Line type 	6.1 Round type (Non-display or display) : <table border="1"> <thead> <tr> <th rowspan="2">Dimension (diameter : Φ)</th> <th colspan="2">Acceptance (Q'ty)</th> </tr> <tr> <th>A area</th> <th>B area</th> </tr> </thead> <tbody> <tr> <td>$\Phi \leq 0.25$</td> <td colspan="2">Ignore</td> </tr> <tr> <td>$0.25 < \Phi \leq 0.50$</td> <td>5</td> <td rowspan="3">Ignore</td> </tr> <tr> <td>$\Phi > 0.50$</td> <td>0</td> </tr> <tr> <td>Total</td> <td>5</td> </tr> </tbody> </table>	Dimension (diameter : Φ)	Acceptance (Q'ty)		A area	B area	$\Phi \leq 0.25$	Ignore		$0.25 < \Phi \leq 0.50$	5	Ignore	$\Phi > 0.50$	0	Total	5	Minor																											
		Dimension (diameter : Φ)		Acceptance (Q'ty)																																									
A area	B area																																												
$\Phi \leq 0.25$	Ignore																																												
$0.25 < \Phi \leq 0.50$	5	Ignore																																											
$\Phi > 0.50$	0																																												
Total	5																																												
6.2 Line type(Non-display or display) : <table border="1"> <thead> <tr> <th rowspan="2">module size</th> <th rowspan="2">Length (L)</th> <th rowspan="2">Width (W)</th> <th colspan="2">Acceptance (Q'ty)</th> </tr> <tr> <th>A area</th> <th>B area</th> </tr> </thead> <tbody> <tr> <td rowspan="4">3.5" to less 9"</td> <td>---</td> <td>$W \leq 0.03$</td> <td colspan="2">Ignore</td> </tr> <tr> <td>$L \leq 10.0$</td> <td>$0.03 < W \leq 0.05$</td> <td>4</td> <td rowspan="4">Ignore</td> </tr> <tr> <td>$L \leq 5.0$</td> <td>$0.05 < W \leq 0.10$</td> <td>2</td> </tr> <tr> <td>---</td> <td>$W > 0.10$</td> <td colspan="2">As round type</td> </tr> <tr> <td colspan="3">Total</td> <td>5</td> </tr> <tr> <td rowspan="4">9" to 15"</td> <td>---</td> <td>$W \leq 0.05$</td> <td colspan="2">Ignore</td> </tr> <tr> <td>$L \leq 10.0$</td> <td>$0.05 < W \leq 0.10$</td> <td>5</td> <td rowspan="4">Ignore</td> </tr> <tr> <td>---</td> <td>$W > 0.10$</td> <td colspan="2">As round type</td> </tr> <tr> <td colspan="3">Total</td> <td>5</td> </tr> </tbody> </table>	module size	Length (L)	Width (W)	Acceptance (Q'ty)		A area	B area	3.5" to less 9"	---	$W \leq 0.03$	Ignore		$L \leq 10.0$	$0.03 < W \leq 0.05$	4	Ignore	$L \leq 5.0$	$0.05 < W \leq 0.10$	2	---	$W > 0.10$	As round type		Total			5	9" to 15"	---	$W \leq 0.05$	Ignore		$L \leq 10.0$	$0.05 < W \leq 0.10$	5	Ignore	---	$W > 0.10$	As round type		Total			5	
module size				Length (L)	Width (W)	Acceptance (Q'ty)																																							
	A area	B area																																											
3.5" to less 9"	---	$W \leq 0.03$	Ignore																																										
	$L \leq 10.0$	$0.03 < W \leq 0.05$	4	Ignore																																									
	$L \leq 5.0$	$0.05 < W \leq 0.10$	2																																										
	---	$W > 0.10$	As round type																																										
Total			5																																										
9" to 15"	---	$W \leq 0.05$	Ignore																																										
	$L \leq 10.0$	$0.05 < W \leq 0.10$	5	Ignore																																									
	---	$W > 0.10$	As round type																																										
	Total				5																																								
07	Polarizer Bubble	<table border="1"> <thead> <tr> <th rowspan="2">Dimension (diameter : Φ)</th> <th colspan="2">Acceptance (Q'ty)</th> </tr> <tr> <th>A area</th> <th>B area</th> </tr> </thead> <tbody> <tr> <td>$\Phi \leq 0.25$</td> <td colspan="2">Ignore</td> </tr> <tr> <td>$0.25 < \Phi \leq 0.50$</td> <td>4</td> <td rowspan="4">Ignore</td> </tr> <tr> <td>$0.50 < \Phi \leq 0.80$</td> <td>1</td> </tr> <tr> <td>$\Phi > 0.80$</td> <td>0</td> </tr> <tr> <td>Total</td> <td>5</td> </tr> </tbody> </table>	Dimension (diameter : Φ)		Acceptance (Q'ty)		A area	B area	$\Phi \leq 0.25$	Ignore		$0.25 < \Phi \leq 0.50$	4	Ignore	$0.50 < \Phi \leq 0.80$	1	$\Phi > 0.80$	0	Total	5	Minor																								
Dimension (diameter : Φ)	Acceptance (Q'ty)																																												
	A area	B area																																											
$\Phi \leq 0.25$	Ignore																																												
$0.25 < \Phi \leq 0.50$	4	Ignore																																											
$0.50 < \Phi \leq 0.80$	1																																												
$\Phi > 0.80$	0																																												
Total	5																																												

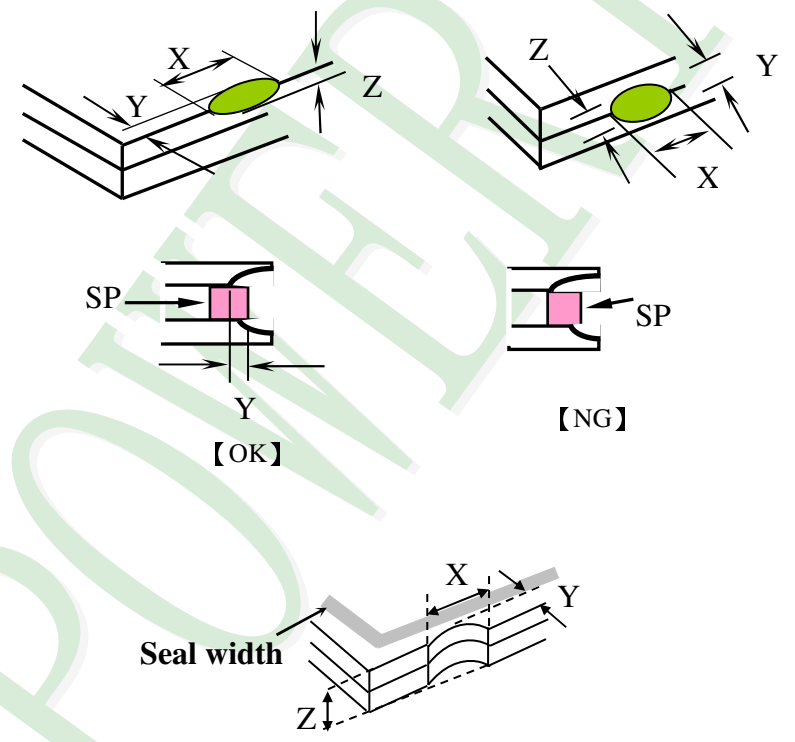
NO	Item	Criterion	Level						
08	The crack of glass	<p>Symbols :</p> <p>X : The length of crack Z : The thickness of crack t : The thickness of glass</p> <p>Y : The width of crack. W : terminal length a : LCD side length</p> <hr/> <p>8.1 General glass chip : 8.1.1 Chip on panel surface and crack between panels:</p> 	Minor						
		<table border="1" data-bbox="539 1579 1353 1870"> <thead> <tr> <th>X</th> <th>Y</th> <th>Z</th> </tr> </thead> <tbody> <tr> <td>$\leq a$</td> <td>Crack can't enter viewing area</td> <td>$\leq 1/2 t$</td> </tr> <tr> <td>$\leq a$</td> <td>Crack can't exceed the half of SP width.</td> <td>$1/2 t < Z \leq 2 t$</td> </tr> </tbody> </table>		X	Y	Z	$\leq a$	Crack can't enter viewing area	$\leq 1/2 t$
X	Y	Z							
$\leq a$	Crack can't enter viewing area	$\leq 1/2 t$							
$\leq a$	Crack can't exceed the half of SP width.	$1/2 t < Z \leq 2 t$							

◆ Specification For TFT-LCD Module 3.5" ~15" :

(Ver.B01)

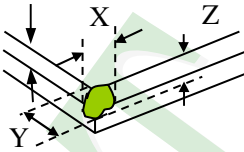
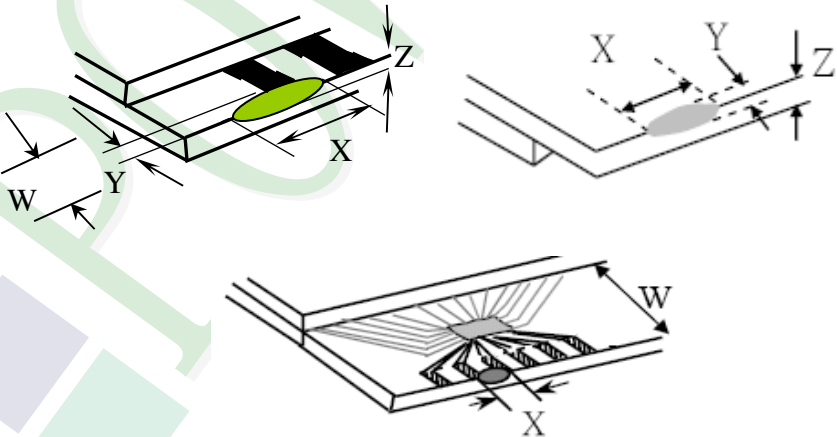
NO	Item	Criterion	Level												
08	The crack of glass	<p>Symbols :</p> <p>X : The length of crack Z : The thickness of crack t : The thickness of glass</p> <p>Y : The width of crack. W : terminal length a : LCD side length</p> <hr/> <p>8.1.2 Corner crack :</p>  <table border="1" data-bbox="520 766 1337 1057"> <thead> <tr> <th>X</th> <th>Y</th> <th>Z</th> </tr> </thead> <tbody> <tr> <td>$\leq 1/5 a$</td> <td>Crack can't enter viewing area</td> <td>$Z \leq 1/2 t$</td> </tr> <tr> <td>$\leq 1/5 a$</td> <td>Crack can't exceed the half of SP width.</td> <td>$1/2 t < Z \leq 2 t$</td> </tr> </tbody> </table>	X	Y	Z	$\leq 1/5 a$	Crack can't enter viewing area	$Z \leq 1/2 t$	$\leq 1/5 a$	Crack can't exceed the half of SP width.	$1/2 t < Z \leq 2 t$				
		X	Y	Z											
$\leq 1/5 a$	Crack can't enter viewing area	$Z \leq 1/2 t$													
$\leq 1/5 a$	Crack can't exceed the half of SP width.	$1/2 t < Z \leq 2 t$													
		<p>8.2 Protrusion over terminal :</p> <p>8.2.1 Chip on electrode pad :</p>  <table border="1" data-bbox="560 1697 1347 1872"> <thead> <tr> <th></th> <th>X</th> <th>Y</th> <th>Z</th> </tr> </thead> <tbody> <tr> <td>Front</td> <td>$\leq a$</td> <td>$\leq 1/2 W$</td> <td>$\leq t$</td> </tr> <tr> <td>Back</td> <td>$\leq a$</td> <td>$\leq W$</td> <td>$\leq 1/2 t$</td> </tr> </tbody> </table>		X	Y	Z	Front	$\leq a$	$\leq 1/2 W$	$\leq t$	Back	$\leq a$	$\leq W$	$\leq 1/2 t$	Minor
	X	Y	Z												
Front	$\leq a$	$\leq 1/2 W$	$\leq t$												
Back	$\leq a$	$\leq W$	$\leq 1/2 t$												

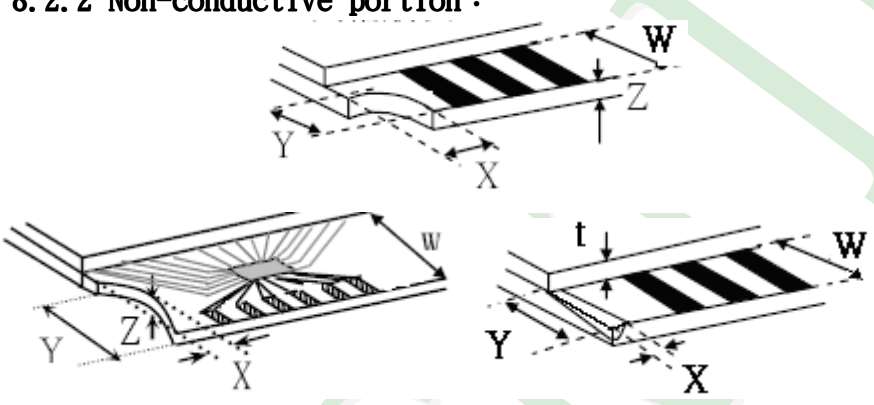
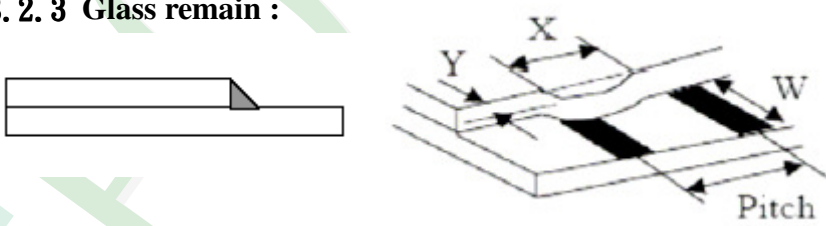
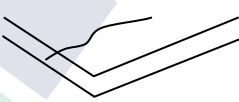
NO	Item	Criterion	Level												
08	The crack of glass	<p>Symbols :</p> <p>X : The length of crack Y : The width of crack. Z : The thickness of crack W : terminal length t : The thickness of glass a : LCD side length</p> <hr/> <p>8.2.2 Non-conductive portion :</p>  <table border="1" data-bbox="625 967 1257 1093"> <thead> <tr> <th>X</th> <th>Y</th> <th>Z</th> </tr> </thead> <tbody> <tr> <td>$\leq 1/3 a$</td> <td>$\leq W$</td> <td>$\leq t$</td> </tr> </tbody> </table> <p>⊙ If the chipped area touches the ITO terminal, over 2/3 of</p> <ul style="list-style-type: none"> ● the ITO must remain and be inspected according to electrode terminal specifications. <p>8.2.3 Glass remain :</p>  <table border="1" data-bbox="545 1523 1241 1648"> <thead> <tr> <th>X</th> <th>Y</th> <th>Z</th> </tr> </thead> <tbody> <tr> <td>$\leq a$</td> <td>$\leq 1/3 W$</td> <td>$\leq t$</td> </tr> </tbody> </table> <p>8.2.4 Cracking</p>  <p style="text-align: center;">Not Allowed</p>	X	Y	Z	$\leq 1/3 a$	$\leq W$	$\leq t$	X	Y	Z	$\leq a$	$\leq 1/3 W$	$\leq t$	Minor
X	Y	Z													
$\leq 1/3 a$	$\leq W$	$\leq t$													
X	Y	Z													
$\leq a$	$\leq 1/3 W$	$\leq t$													

◆Specification For TFT-LCD Module 3.5" ~15" :
(Ver.B01)

NO	Item	Criterion	Level
09	Backlight elements	9. 1 Backlight can't work normally.	Major
		9. 2 Backlight doesn't light or color is wrong.	Major
		9. 3 Illumination source flickers when lit.	Major
10	General appearance	10. 1 Pin type 、 quantity 、 dimension must match type in structure diagram.	Major
		10. 2 No short circuits in components on PCB or FPC .	Major
		10. 3 Parts on PCB or FPC must be the same as on the production characteristic chart .There should be no wrong parts , missing parts or excess parts.	Major
		10. 4 Product packaging must the same as specified on packaging specification sheet.	Minor
		10. 5 The folding and peeled off in polarizer are not acceptable.	Minor
		10. 6 The PCB or FPC between B/L assembled distance(PCB or FPC) is ≤ 1.5 mm.	Minor

4. 1 Reliability Test Condition

(Ver.B01)

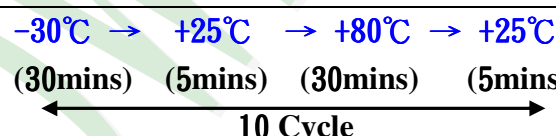
NO.	TEST ITEM	TEST CONDITION											
1	High Temperature Storage Test	Keep in +80 ±2°C 96 hrs Surrounding temperature, then storage at normal condition 4hrs.											
2	Low Temperature Storage Test	Keep in -30 ±2°C 96 hrs Surrounding temperature, then storage at normal condition 4hrs.											
3	High Temperature / High Humidity Storage Test	Keep in +60°C / 90% R.H duration for 96 hrs Surrounding temperature, then storage at normal condition 4hrs. (Excluding the polarizer)											
4	ESD Test	Air Discharge: (include mobile phone) Apply 2 KV with 5 times Discharge for each polarity +/-	Contact Discharge: (include mobile phone) Apply 250V with 5 times discharge for each polarity +/-										
		<ol style="list-style-type: none"> 1. Temperature ambience: 15°C ~ 35°C 2. Humidity relative: 30% ~ 60% 3. Energy Storage Capacitance(Cs+Cd): 150pF±10% 4. Discharge Resistance(Rd): 330Ω±10% 5. Discharge, mode of operation: Single Discharge (time between successive discharges at least 1 s) (Tolerance if the output voltage indication: ±5%) 											
5	Temperature Cycling Storage Test	<p style="text-align: center;"> -30°C → +25°C → +80°C → +25°C (30mins) (5mins) (30mins) (5mins)  </p> Surrounding temperature, then storage at normal condition 4hrs.											
6	Vibration Test (Packaged)	<ol style="list-style-type: none"> 1. Sine wave 10~55 Hz frequency (1 min) 2. The amplitude of vibration : 1.5 mm 3. Each direction (X、Y、Z) duration for 2 Hrs 											
7	Drop Test (Packaged)	<table border="1" style="margin-left: auto; margin-right: auto;"> <thead> <tr> <th>Packing Weight (Kg)</th> <th>Drop Height (cm)</th> </tr> </thead> <tbody> <tr> <td>0 ~ 45.4</td> <td>122</td> </tr> <tr> <td>45.4 ~ 90.8</td> <td>76</td> </tr> <tr> <td>90.8 ~ 454</td> <td>61</td> </tr> <tr> <td>Over 454</td> <td>46</td> </tr> </tbody> </table> <p style="text-align: center;">Drop direction :※ 1 corner / 3 edges / 6 sides each 1times</p>		Packing Weight (Kg)	Drop Height (cm)	0 ~ 45.4	122	45.4 ~ 90.8	76	90.8 ~ 454	61	Over 454	46
Packing Weight (Kg)	Drop Height (cm)												
0 ~ 45.4	122												
45.4 ~ 90.8	76												
90.8 ~ 454	61												
Over 454	46												

5. PRECAUTION RELATING PRODUCT HANDLING

5.1 SAFETY

- 5.1.1 If the LCD panel breaks , be careful not to get the liquid crystal to touch your skin.
- 5.1.2 If the liquid crystal touches your skin or clothes , please wash it off immediately by using soap and water.

5.2 HANDLING

- 5.2.1 Avoid any strong mechanical shock which can break the glass.
- 5.2.2 Avoid static electricity which can damage the CMOS LSI—When working with the module , be sure to ground your body and any electrical equipment you may be using.
- 5.2.3 Do not remove the panel or frame from the module.
- 5.2.4 The polarizing plate of the display is very fragile. So , please handle it very carefully ,do not touch , push or rub the exposed polarizing with anything harder than an HB pencil lead (glass , tweezers , etc.)
- 5.2.5 Do not wipe the polarizing plate with a dry cloth , as it may easily scratch the surface of plate.
- 5.2.6 Do not touch the display area with bare hands , this will stain the display area.
- 5.2.7 Do not use ketonics solvent & aromatic solvent. Use with a soft cloth soaked with a cleaning naphtha solvent.
- 5.2.8 To control temperature and time of soldering is $320\pm 10^{\circ}\text{C}$ and 3-5 sec.
- 5.2.9 To avoid liquid (include organic solvent) stained on LCM .

5.3 STORAGE

- 5.3.1 Store the panel or module in a dark place where the temperature is $25^{\circ}\text{C} \pm 5^{\circ}\text{C}$ and the humidity is below 65% RH.
- 5.3.2 Do not place the module near organics solvents or corrosive gases.
- 5.3.3 Do not crush , shake , or jolt the module.

5.4 TERMS OF WARRANTY

- 5.4.1 Applicable warrant period
The period is within thirteen months since the date of shipping out under normal using and storage conditions.
- 5.4.2 Unaccepted responsibility
This product has been manufactured to your company's specification as a part for use in your company's general electronic products. It is guaranteed to perform according to delivery specifications. For any other use apart from general electronic equipment , we cannot take responsibility if the product is used in nuclear power control equipment , aerospace equipment , fire and security systems or any other applications in which there is a direct risk to human life and where extremely high levels of reliability are required.

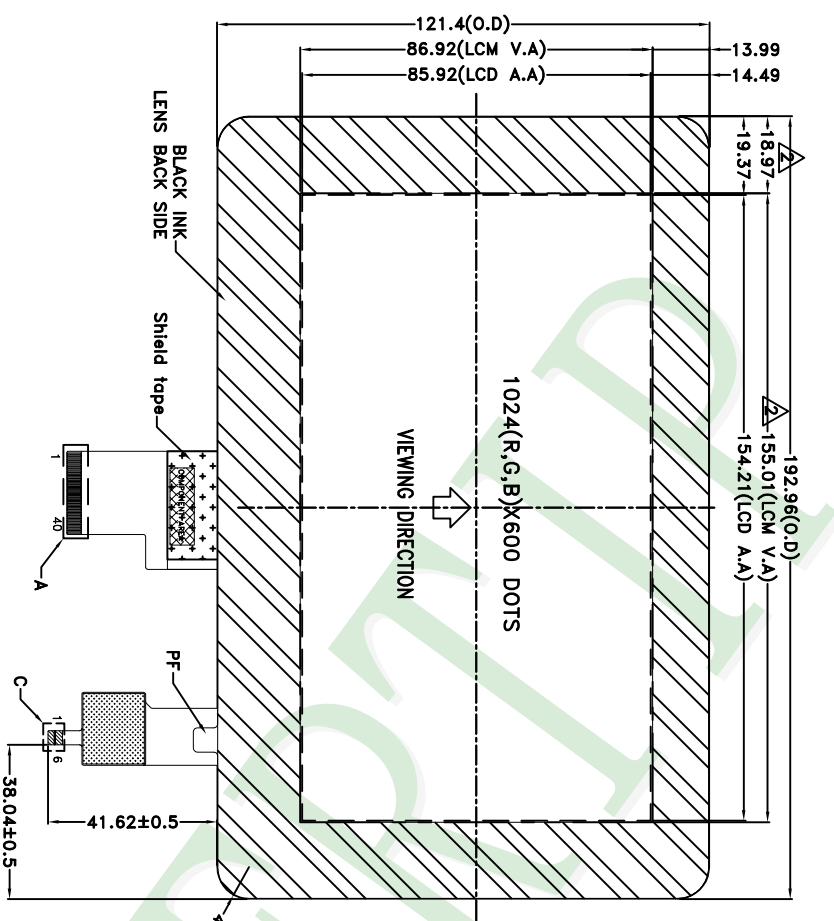

NOTES:
 1.LCD TYPE: a-Si TFT
 2.LCD DISPLAY: POSITIVE/TRANSMISSIVE
 3.VIEW DIRECTION: 6 O'CLOCK
 4.The tolerance unless classified ±0.3mm
 5.B.P0.5X39=19.5±0.05; W=0.3±0.05
 6.⊗FPC Component Ared(H=1.0Max);
 7.FPC suggested connector : HIROSE FH12A-40S-0.5SH or compatible
 TP FPC suggested connector : HIROSE FH34S-6S-0.5SH or compatible

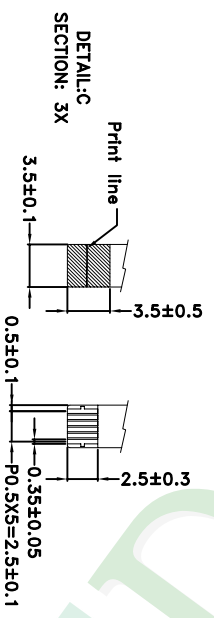

-0.1506-		
R	G	B
-0.1432-		

007					
006					
005					
004					
003					
002	Modify thickness / dimensions / LCM V.A	Mandy	2017/08/15		
001	NEW DRAWING	Mandy	2017/06/20		
REV	REV BY	REVISER	DATE		

PART NO:	PH102600T009-IBC03
DRAWING NAME:	LMD-PH102600T009-IBC03
TITLE:	LCD MODULE DRAWING

Design	Mandy Chang
Check	Tina Chen
Approve	Jimmy Chen

久正光電股份有限公司
 POWER TIP TECHNOLOGY CORPORATION

Unit	MM
Scale	1:1
Page	1/1
Surface	(3)
Material	
Thickness	
Quantity	

Tolerance (mm)	Precision Level
1 ~ 4	-
4 ~ 16	-
16 ~ 63	-
63 ~ 250	-
250 ~ 1000	-

Ver.002

Documents NO. PKG-PH102600T009-IBC03

LCM包裝規格書

LCM Packaging Specifications

Approve	Check	Contact
Jimmy	Tina	Mandy

1. 包裝材料規格表 (Packaging Material) : (per carton)

No.	Item	Model	Dimensions (mm)	1Pcs Weight	Quantity	Total Weight
1	成品 (LCM)	PH102600T009-IBC03	192.96X121.4X4.58	0.1687	60	10.122
2	靜電袋(1)Antistatic Bag	BAG240170ARABA	240 X 170	0.0048	60	0.288
3	氣泡袋(2)Bubble Bag	BAG170150BRABA	170 X 150	0.0045	60	0.27
4	A9隔板(3)A9 Partition	BX00000000058	245 X 125 X 4	0.0204	64	1.3056
5	B9隔板(4)B9 Partition	BX00000000057	295 X 125 X 4	0.0209	8	0.1672
6	海綿墊(5)Foam Rubber Cushion	OTFOAM00006ABA	290 X 240 X 10	0.02	8	0.16
7	C5內盒(6)Product Box	BX00000000059	310 X 255 X 155	0.248	4	0.992
8	外紙箱(7)Carton	BX52732536CCBA	527 X 325 X 360	0.83	1	0.83
9	保麗龍板(8)Polylon board 	OTPLB00000017	510 X 310 X 15	0.025	1	0.025

2. 一整箱總重量 (Total LCD Weight in carton) : $\triangle 14.16$ Kg $\pm 10\%$

3. 單箱數量規格表 (Packaging Specifications and Quantity) :

- (1)Quantity Of Spacer : A9隔板 X 16 , B9隔板 X 2
- (2)Total LCM quantity in carton : quantity per box 15 x no of boxes 4 = 60

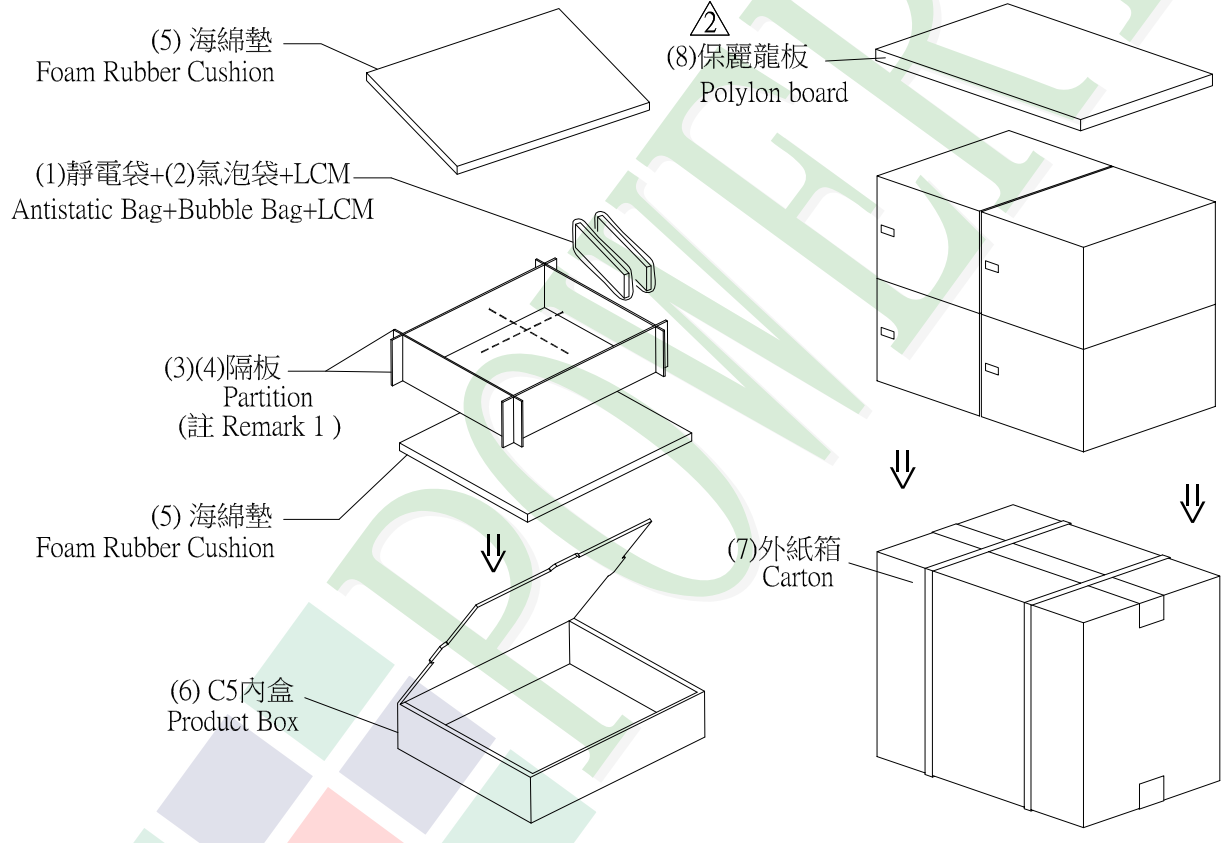

特 記 事 項 (REMARK)

4. LCM排放示意圖(前後間隔不放置):
 4. LCM placed as figure showing:
 (First and last slot should be empty)

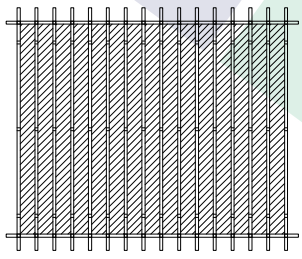

 模組(LCM) X 1pcs.