



SPECIFICATIONS

CUSTOMER	PTI
SAMPLE CODE	SH176220T062-LAB01
MASS PRODUCTION CODE	PH176220T062-LAB01
SAMPLE VERSION	02
SPECIFICATIONS EDITION	008
DRAWING NO. (Ver.)	JLMD- PH176220T062-LAB01_001
PACKAGING NO. (Ver.)	JPKG- PH176220T062-LAB01_002

Customer Approved

Date:

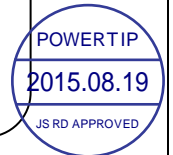

Approved	Checked	Designer
閔偉	劉進	譚超敏

- Preliminary specification for design input
- Specification for sample approval

POWERTIP TECH. CORP.

Headquarters: No.8, 6th Road, Taichung Industrial Park,
Taichung, Taiwan
台中市 407 工業區六路 8 號

TEL: 886-4-2355-8168
FAX: 886-4-2355-8166

E-mail: sales@powertip.com.tw
Http://www.powertip.com.tw

History of Version

Date <small>(mm / dd / yyyy)</small>	Ver.	Edi.	Description	Page	Design by
07/22/2014	01	001	New Drawing.	-	譚超敏
08/18/2014	01	002	New Sample	-	譚超敏
09/11/2014	01	003	Update the Packaging	Appendix	譚超敏
10/24/2014	01	004	Show Bill of material	Appendix	譚超敏
11/27/2014	02	005	Change the TP supplier	Appendix	譚超敏
03/19/2015	02	006	Change the Backlight Characteristics	11	譚超敏
06/04/2015	02	007	Change Bill of material	Appendix	譚超敏
08/18/2015	02	008	Add Silicone using in Touch Panel	12	譚超敏

Total: 33 Page

Contents

1. SPECIFICATIONS

- 1.1 Features
- 1.2 Mechanical Specifications
- 1.3 Absolute Maximum Ratings
- 1.4 DC Electrical Characteristics
- 1.5 Optical Characteristics
- 1.6 Backlight Characteristics
- 1.7 Touch Panel Characteristics

2. MODULE STRUCTURE

- 2.1 Counter Drawing
- 2.2 Interface Pin Description
- 2.3 Timing Characteristics

3. QUALITY ASSURANCE SYSTEM

- 3.1 Quality Assurance Flow Chart
- 3.2 Inspection Specification

4. RELIABILITY TEST

- 4.1 Reliability Test Condition

5. PRECAUTION RELATING PRODUCT HANDLING

- 5.1 Safety
- 5.2 Handling
- 5.3 Storage
- 5.4 Terms of Warranty

- Appendix :
- 1. LCM Drawing
 - 2. Bom of material
 - 3. Packaging

1. SPECIFICATIONS

1.1 Features

Main LCD Panel

Item	Standard Value
Display Type	176 * (RGB) * 220 Dots
LCD Type	Color TFT , Positive/Nomal White, Transmissive type
Screen size(inch)	2.0"(Diagonal)
Viewing Direction	12 O'clock
Color configuration	RGB vertical Strip
Interface	SPI 4 interface
Other(controller/driver IC)	ILITEK_ILI9225G
ROHS	THIS PRODUCT CONFORMS THE ROHS OF PTC Detail information please refer web site : http://www.powertip.com.tw/news.php?area_id_view=1085560481/

1.2 Mechanical Specifications

Item	Standard Value	Unit
Outline Dimension	41.42(W) x 51.6 (L) x 4.7(H)	mm

LCD panel& Touch Panel

Item	Standard Value	Unit
Viewing Area (TP)	33.02 (W) * 41.2 (L)	mm
Active Area (TP)	32.48 (W) * 40.4 (L)	mm
Active Area (LCD)	31.68 (W) * 39.6 (L)	mm

Note : For detailed information please refer to LCM drawing

1.3 Absolute Maximum Ratings

Module

Item	Symbol	Condition	Min.	Max.	Unit
System Power Supply Voltage	VDD	-	-0.3	+4.6	V
	VGH-VGL	-	-0.3	+30	V
Operating Temperature	T _{OP}	-	-20	+70	°C
Storage Temperature	T _{ST}	-	-30	+80	°C
Storage Humidity	H _D	T _a < 60 °C	20	90	%RH

1.4 DC Electrical Characteristics

Module

GND = 0V, T_a = 25°C

Item	Symbol	Condition	Min.	Typ.	Max.	Unit
Power Supply Voltage	VDD	-	2.8	3.3	3.5	V
Input H/L Level Voltage	V _{IH}	-	0.8VDD	-	VDD	V
	V _{IL}	-	GND	-	0.2VDD	V
Output H/L Level Voltage	V _{OH}	I _{OH} =-0.1mA	0.8VDD	-	VDD	V
	V _{OL}	I _{OL} =0.1mA	GND	-	0.2VDD	V
Supply Current	I _{DD}	VDD = 3.3 V Pattern= black *1	-	5.0	7.5	mA
Power consumption	PD	VDD=VDDI	-	16.5	-	mW

Note 1: Maximum current display

1.5 Optical Characteristics

TFT LCD Module

VDD= 2.8 V, Ta=25°C

Item	Symbol	Condition	Min.	Typ.	Max.	unit	-	
Response time	Tr+Tf	-	-	25	38	ms	Note2	
Viewing angle	Top	$\theta+$	CR \geq 10	-	60	-	Deg	Note1
	Bottom	$\theta-$		-	60	-		
	Left	θ_L		-	60	-		
	Right	θ_R		-	60	-		
Contrast ratio	CR	-	500	600	-	-	Note3	
Color of CIE Coordinate (With B/L&TP)	White	X	IF= 60 mA	0.24	0.29	0.34	-	Note4
		Y		0.27	0.32	0.37		
	Red	X		0.51	0.56	0.61		
		Y		0.29	0.34	0.39		
	Green	X		0.26	0.31	0.36		
		Y		0.55	0.60	0.65		
	Blue	X		0.10	0.15	0.20		
		Y		0.02	0.07	0.12		
Average Brightness Pattern=white display (With B/L&TP)	IV	IF= 60 mA	130	150	-	cd/m ²		
Uniformity (With B/L&TP)	ΔB		80	-	-	%		

Note 1:

*1 : $\Delta B = B(\min) / B(\max) * 100\%$

*2 : Measurement Condition for Optical Characteristics:

a : Environment: $25^\circ\text{C} \pm 5^\circ\text{C}$ / $60 \pm 20\%$ R.H , no wind , dark room below 10 Lux at typical lamp current and typical operating frequency.

b : Measurement Distance: 500 ± 50 mm , ($\theta = 0^\circ$)

c : Equipment: TOPCON BM-7 fast , (field 1°) , after 10 minutes operation.

d : The uncertainty of the C.I.E coordinate measurement ± 0.01 , Average Brightness $\pm 4\%$

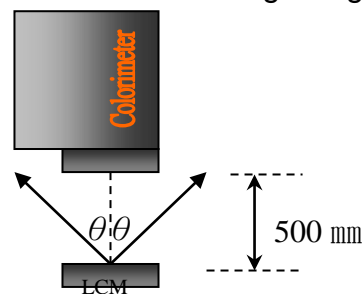
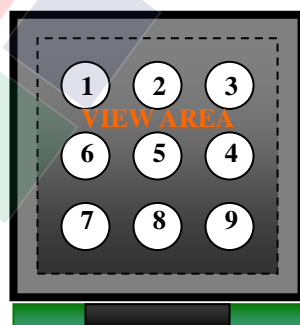

Colorimeter=BM-7 fast

Note 1.

Optical characteristics-2

Viewing angle

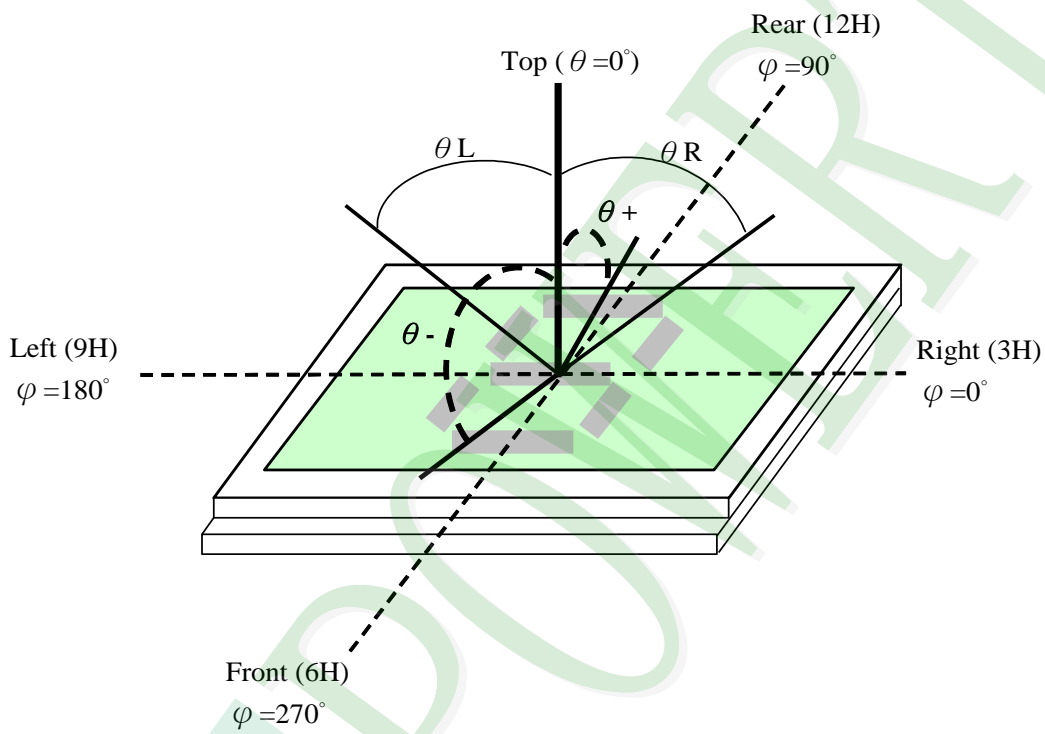

Viewing angle

Note 2.

Optical characteristics-3

Fig.2 Definition of response time

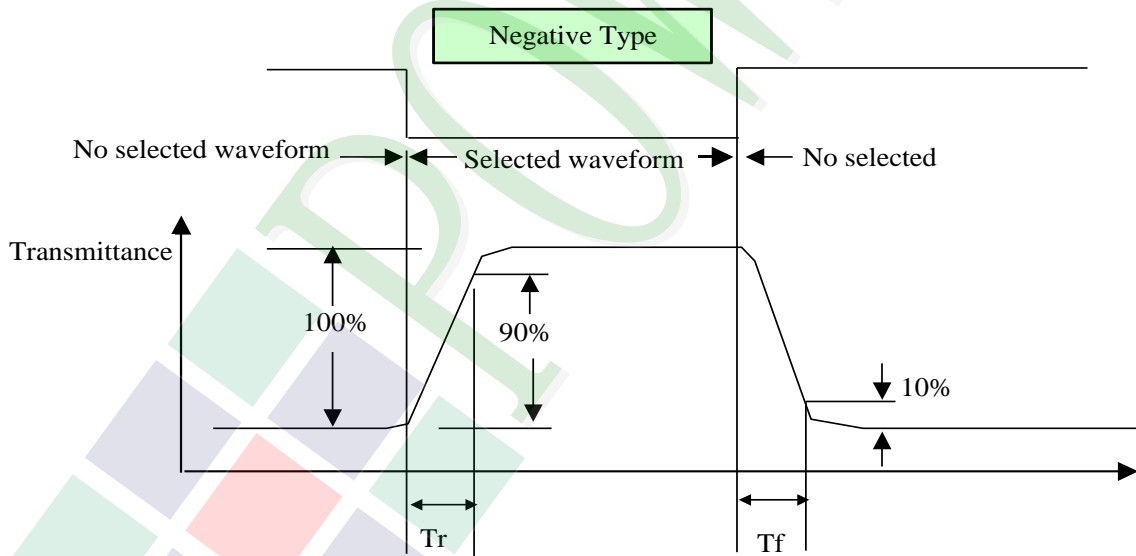
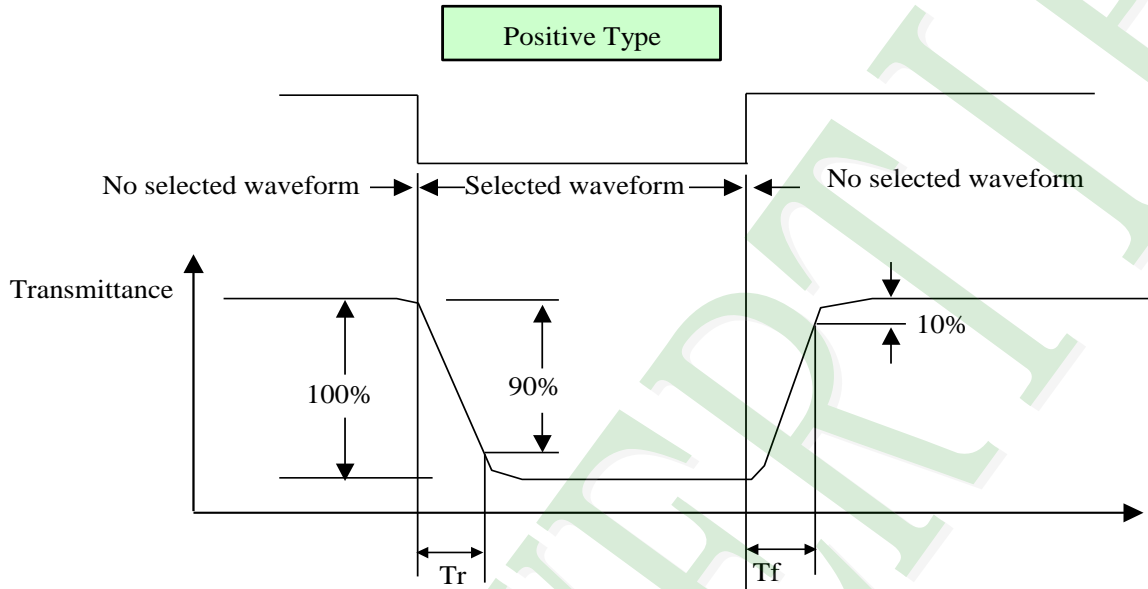

Electrical characteristics-2

※2 Drive waveform

V_{op}: Drive voltage

f_F: Frame frequency

1/B: Bias

f_D: Drive frequency

N: Duty

(1) Selected waveform

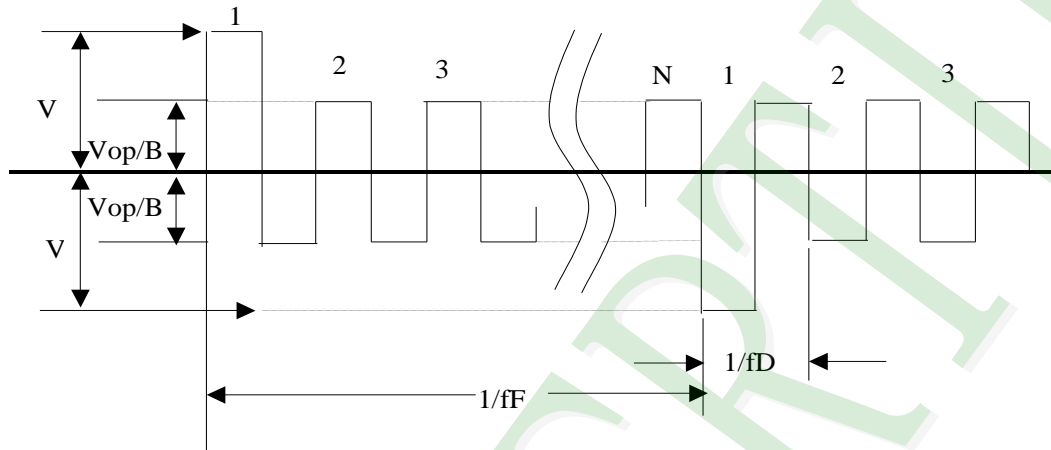

(2) Non- Selected wave form

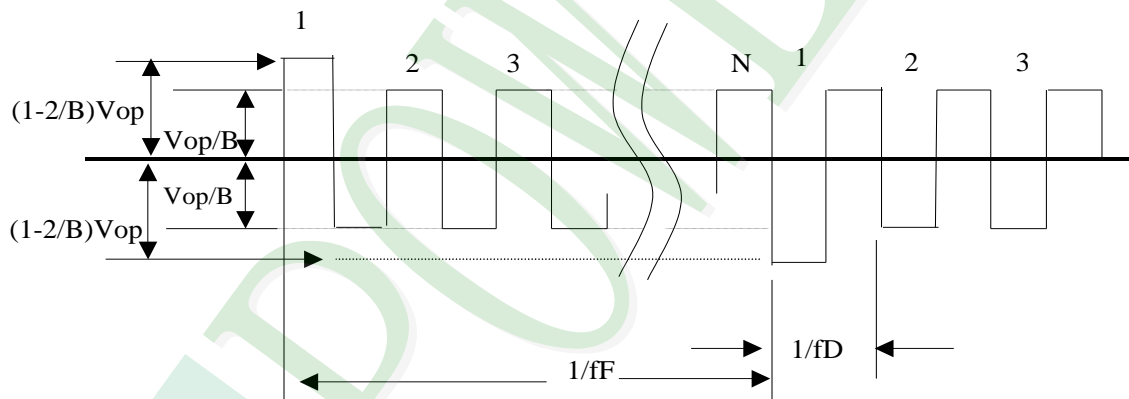

Note:

Frame frequency is defined as follows: Common side supply voltage peak - to - peak / 2 = 1 period

Note 3. : Definition of Vth

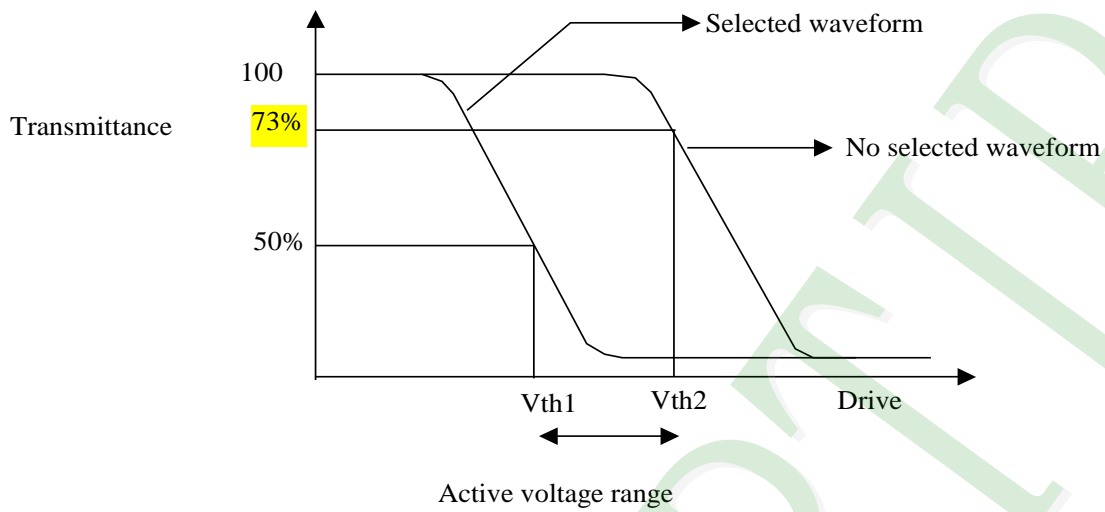

	Vth1	Vth2
View direction	10°	40°
Drive waveform	(Selected waveform)	(No selected waveform)
Transmittance	50%	73%

※ 1 Contrast ratio
 = (Brightness in OFF state) / (Brightness in ON state)

Outline of Electro-Optical Characteristics Measuring System

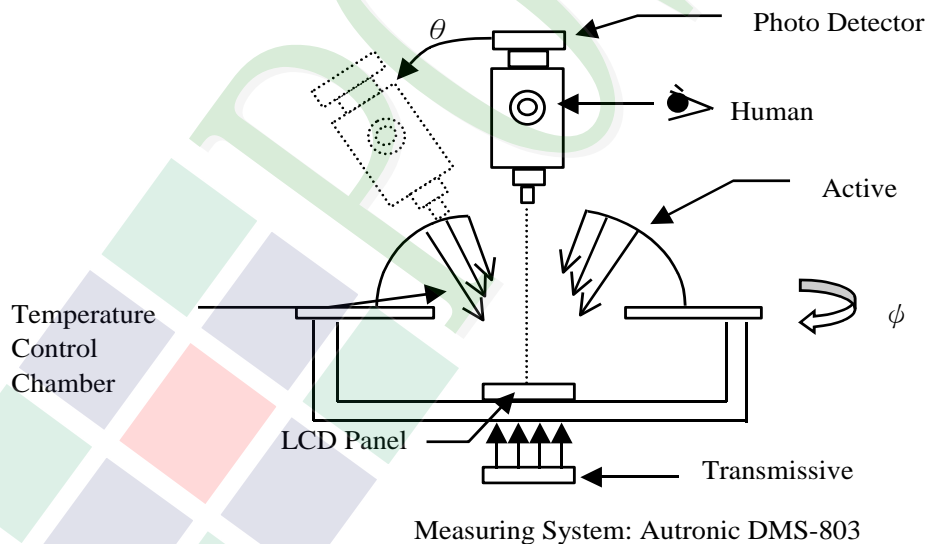

1.6 Backlight Characteristics

Maximum Ratings

Item	Symbol	Conditions	Min.	Max.	Unit
LED Forward Current	IF	Ta =25°C	-	75	mA
LED Reverse Voltage	VR	Ta =25°C	-	4	V
Power Dissipation	PD	Ta =25°C	-	260	mW

Electrical / Optical Characteristics

Item	Symbol	Conditions	Min.	Typ.	Max.	Unit
Forward Voltage	VF	IF= 60mA	2.65	3.0	3.5	V
Average Brightness (Without LCD)	IV		3500	4200	-	cd/m ²
CIE Color Coordinate (Without LCD)	X		0.25	0.27	0.295	-
	Y		0.25	0.27	0.295	
Color		White				

Circuit diagram

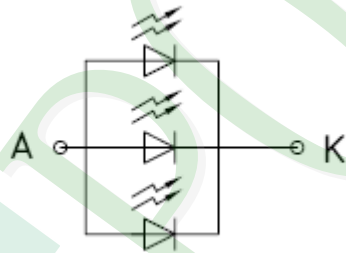

1.7 Touch Panel Characteristics

1.7.1 Optical Characteristics

Item	Specification
1. Transparency	80% Min

1.7.2 Mechanical Characteristic

Item	Specification
1. Input Method	Finger or stylus pen
2. ITO Glass	T=0.7mm
3. ITO Film	T=0.188mm, NITTO V270
4. Touch Panel Supplier	Raece
5. Silicone using in Touch panel	Dow Corning 734
6. Hardness of surface	3H -pressure 500g of ,45deg.
7. Activation Force	50gf less individual point with stylus pen(R0.8) Activation force guarantee area:2.0mm inside of Active Area.
8. Linearity Force	80gf less input with stylus pen(R0.8) Activation force guarantee area:3.0mm inside of Active Area.

1.7.3 Electrical Characteristics

Item	Specification
1. Rated Voltage	DC 5V(DC 7V Max)
2. Resistance Between Terminals.	Direction X (Glass side): 100Ω~ 600Ω
	Direction Y (Film side): 250Ω~ 900Ω
3. Insulation Resistance	20 MΩ or more (DC 25V 1min)
4. Linearity	±1.5% Linearity(%)= $\Delta V / (EV - SV) * 100$. ΔV: The difference between the ideal voltage and measured voltage on the each measuring line. SV: Voltage of starting Points. EV: Voltage of Ending Points. (Test condition refers to 1.7.2 item5)
5. Bouncing	<10ms (Tip R 3.75mm, hardness 10°~20° ,silicon rubber ,500gf operation : 40 mm/sec)

1.7.4 Reliability Characteristic

NO	Test Item	Test Condition	Test Result
1	Hitting Durability	1,000,000times min.(R 8 mm Silicon Rubber Hardness 60°250gf 2times/sec).	Follow 1.7.3 item2 and item4.
2	Impact Resistance	φ9mm steel ball is dropped on the surface from 30 cm height at 1 time.	No Crack
3	Flexible pattern Bending Resistance	Bending 3 times by bending radius R1.0 mm	Follow 1.7.3 item2.

1.7.5 Touch Panel Design/Handing Guide

- (1) Keep the gap, for example 0.2 to 0.3mm, between bezel edge and T/P edge.
The reason is to avoid the bezel edge from contacting T/P surface that may cause “short” with bottom layer
- (2) Insertion a cushion material is recommended.
- (3) The cushion material should be limited on the busbar insulation paste area. If it is over the transparent insulation paste area, a “short” may be occurred.
- (4) Do not to use an adhesive tape to bond it on the front of T/P and hang it to the housing bezel.
- (5) Never expand the T/P top layer (PET Film) like a balloon by internal air pressure. The life of the T/P will extremely decreasing.
- (6) Top layer, PET, dimension is changing base on environment temperature and humidity. Please avoid a stress from housing bezel to top layer, because it may cause “waving”.
- (7) The input to the Touch Panel sometimes distorts touch panel itself.
- (8) To use the stylus pen or fingernail sliding at the edge of the housing is prohibited. It would cause the cracking of the ITO coating and damage the touch panel. It also request not to press this area while assembling
- (9) Purpose: In order to prevent accidental use and performance deterioration, please keep the following precautions.

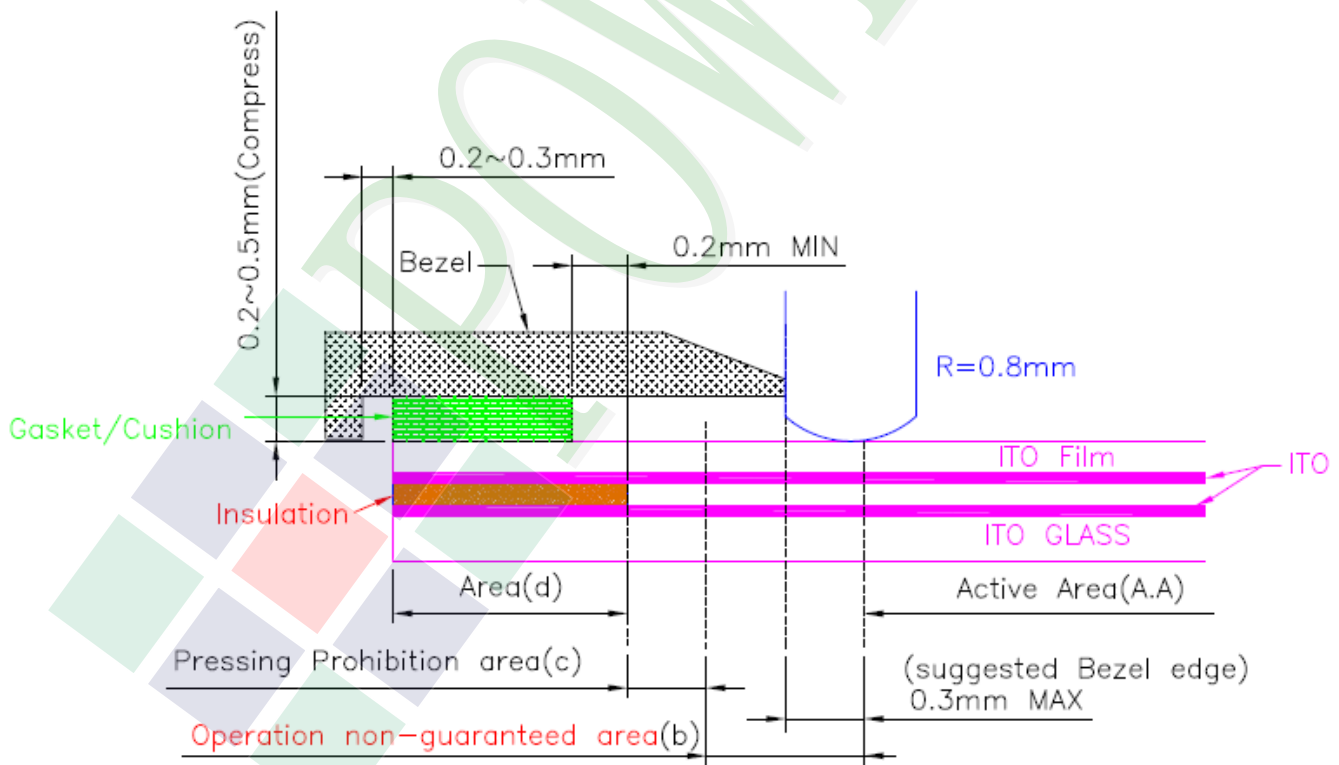

In order to prevent unusual performance degradation and malfunction of a touch panel, please carry out the set case designing and a touch panel assembling method after surely considering the

definition of each area illustrated in above figure.

Area(a) : Active area

The active area is guaranteed the position data detectable precision, operation force and other operations. it is strongly recommended to place the operation button or menu keys within the active area. Due to structure, the active area is less durable at the edge or close to the edge.

Area(b) : Operation non-guaranteed area

This area does not guarantee a touch panel operation and its function. When this area is pressed, touch panel shows degradation of its performance and durability such as a pen sliding durability becomes about one-tenth compared with the active area (area-(a) as guaranteed area) and its operation force requires about double. About 0.5 mm outside from a boundary of the active area corresponds to this area.

Area(c) : Pressing prohibition area

The area which forbids pressing, because an excessive load is applied to a transparent electrode (ITO) and a serious damage is given to a touch panel function by pressing. About 0.5 mm outside from Operation non-guaranteed area .

The space(0.2mm min) of pressing prohibition area and gasket opening is based on the typical design. If considering the tolerance, then the gasket opening do not exceed the pressing prohibition area.

Area(d) : Non-Active area

The area does not activate even if pressed.

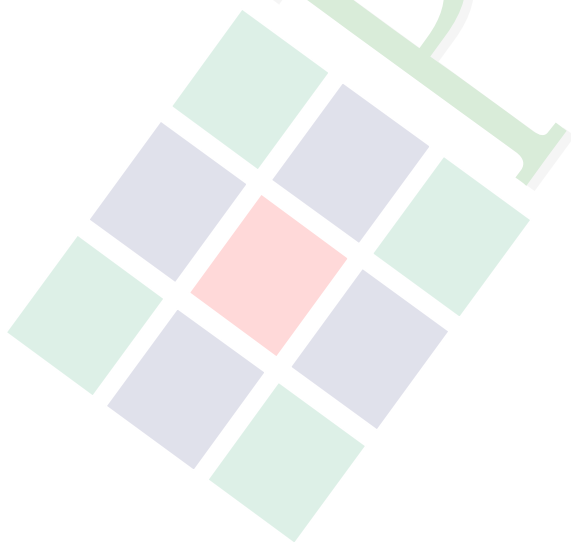

2. MODULE STRUCTURE

2.1 Counter Drawing

2.1.1 LCM Mechanical Diagram

* See Appendix

2.1.2 Block Diagram

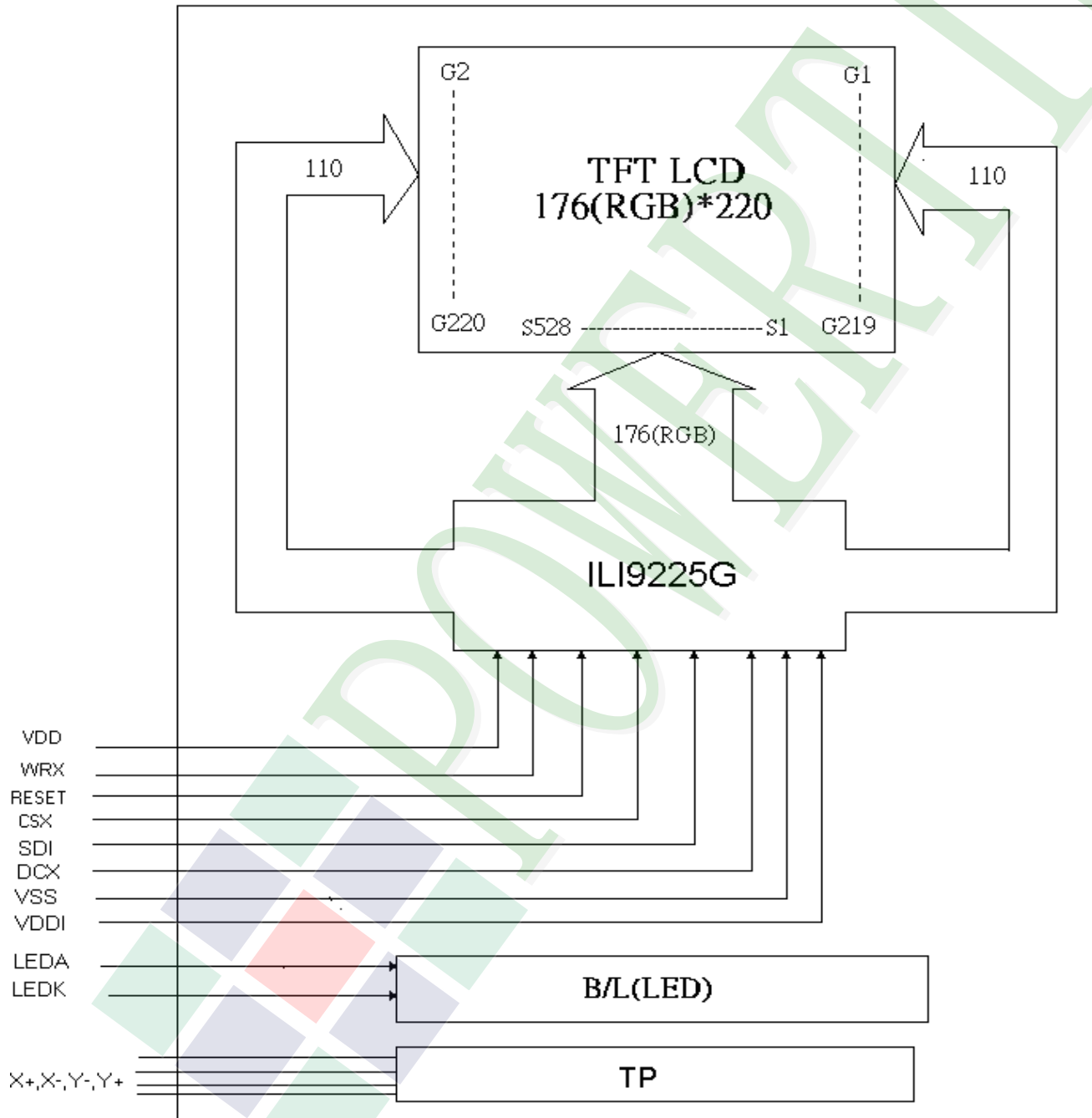

2.2 Interface Pin Description

Pin No.	Symbol	Function
1	LEDA	LED Backlight anode
2	LEDK	LED Backlight cathode
3	VDD	Power Supply for Analog, Digital System and Booster Circuit
4	WRX (SCL)	-Write enable in MCU parallel interface. In SPI mode, this is used as SCL.
5	RESET	-This signal will reset the device and it must be applied to properly initialize the chip. -Signal is active low.
6	CSX	-Chip selection pin Low enable. High disable.
7	SDI	-SPI interface input pin. -The data is latched on the rising edge of the SCL signal.
8	DCX (RS)	-Display data/command selection pin in MCU interface. DCX='1': display data or parameter. DCX='0': command data. -If not used, please fix this pin at VDDI or DGND level.
9	VSS	System Ground
10	VDDI	Power Supply for I/O system
11	X-	Touch Panel :X Right Side
12	Y-	Touch Panel :Y Down Side
13	X+	Touch Panel :X Left Side
14	Y+	Touch Panel :Y Up Side

2.2.1 Refer Initial code

```
void int_lcd()
{
    write_com(0x00,0xd0);
    write_dat(0x00,0x03);

    write_com(0x00,0xeb);
    write_dat(0x0b,0x00);

    write_com(0x00,0xec);
    write_dat(0x00,0x4f);

    write_com(0x00,0xc7);
    write_dat(0x03,0x0f);

    write_com(0x00,0x01); // Driver Output Control
    write_dat(0x01,0x1c); // set SS and NL bit

    write_com(0x00,0x02); // Driver Output Control
    write_dat(0x01,0x00); // set 1 line inversion

    write_com(0x00,0x03); // Entry Mode
    write_dat(0x10,0x30); // set GRAM write direction and BGR=1.

    write_com(0x00,0x08); // Blank Period Control 1
    write_dat(0x08,0x08); // set BP and FP

    write_com(0x00,0x0f);
    write_dat(0x09,0x01);

    write_com(0x00,0x20);
    write_dat(0x00,0x00);

    write_com(0x00,0x21);
    write_dat(0x00,0x00);

    write_com(0x00,0x07);
    write_dat(0x10,0x17);
    delay(50);
    /*******Power On sequence *****/
    write_com(0x00,0x10);
    write_dat(0x00,0x00);

    write_com(0x00,0x11);
    write_dat(0x1b,0x41);

    write_com(0x00,0x12);
    write_dat(0x20,0x0e);

    write_com(0x00,0x13);
    write_dat(0x00,0x52);
```

```
write_com(0x00,0x14);
write_dat(0x5a,0x66);
//----- Set GRAM area -----//
write_com(0x00,0x30);
write_dat(0x00,0x00);

write_com(0x00,0x31);
write_dat(0x00,0xdb);

write_com(0x00,0x32);
write_dat(0x00,0x00);

write_com(0x00,0x33);
write_dat(0x00,0x00);

write_com(0x00,0x34);
write_dat(0x00,0xdb);

write_com(0x00,0x35);
write_dat(0x00,0x00);

write_com(0x00,0x36);
write_dat(0x00,0xaf);

write_com(0x00,0x37);
write_dat(0x00,0x00);

write_com(0x00,0x38);
write_dat(0x00,0xdb);

write_com(0x00,0x39);
write_dat(0x00,0x00);
// ----- Adjust the Gamma Curve -----//
write_com(0x00,0x50);
write_dat(0x00,0x00);

write_com(0x00,0x51);
write_dat(0x01,0x0c);

write_com(0x00,0x52);
write_dat(0x0a,0x01);

write_com(0x00,0x53);
write_dat(0x04,0x01);

write_com(0x00,0x54);
write_dat(0x02,0x0a);

write_com(0x00,0x55);
write_dat(0x0b,0x00);
```



```
write_com(0x00,0x56);  
write_dat(0x00,0x00);
```

```
write_com(0x00,0x57);  
write_dat(0x01,0x04);
```

```
write_com(0x00,0x58);  
write_dat(0x0e,0x05);
```

```
write_com(0x00,0x59);  
write_dat(0x05,0x0e);
```

```
write_com(0x00,0x22);
```

```
}
```



2.3 Timing Characteristics

2.3.1 Serial Data Transfer Interface Characteristics:

(IOVCC= 1.65~3.3V and VCI=2.5~3.3V)

Item	Symbol	Unit	Min.	Max.	Test Condition	
Serial clock cycle time	Write (received)	t_{SCYC}	ns	80	-	IOVCC=1.65~2.8V
	Write (received)	t_{SCYC}	ns	25	-	IOVCC=2.8~3.3V
	Read (transmitted)	t_{SCYC}	ns	200	-	
Serial clock high – level pulse width	Write (received)	t_{SCH}	ns	40	-	IOVCC=1.65~3.3V
	Read (transmitted)	t_{SCH}	ns	90	-	
Serial clock low – level pulse width	Write (received)	t_{SCL}	ns	40	-	IOVCC=1.65~3.3V
	Read (transmitted)	t_{SCL}	ns	90	-	
Serial clock rise / fall time	t_{SCR}, t_{SCF}	ns	-	5		
Chip select set up time	t_{CSU}	ns	10	-		
Chip select hold time	t_{CH}	ns	10	-		
Serial input data set up time	t_{SISU}	ns	5	-		
Serial input data hold time	t_{SIH}	ns	5	-		
Serial output data set up time	t_{SOD}	ns	-	200		
Serial output data hold time	t_{SOH}	ns	10	-		

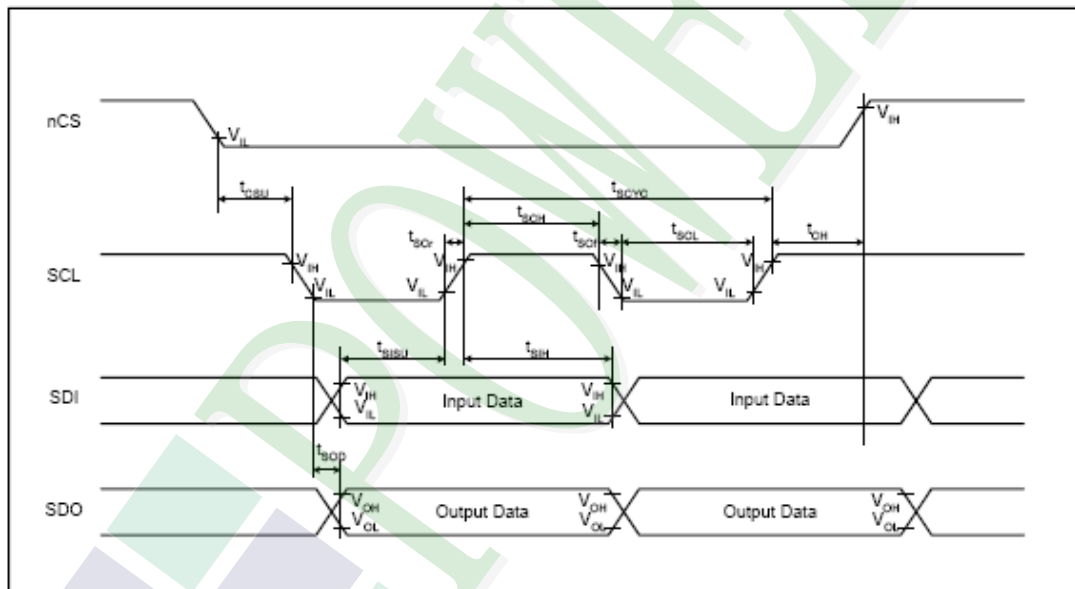

LCD Reset

Reset Timing Characteristics (IOVCC = 1.65 ~ 3.3V)

Item	Symbol	Unit	Min.	Typ.	Max
Reset front high-level with	t_{RES_FH}	ms	1		
Reset low-level width	t_{RES_L}	μs	20		
Reset back high-level width	t_{RES_BH}	ms	50		
Reset rise time	t_{rRES}	μs			10

nRESET

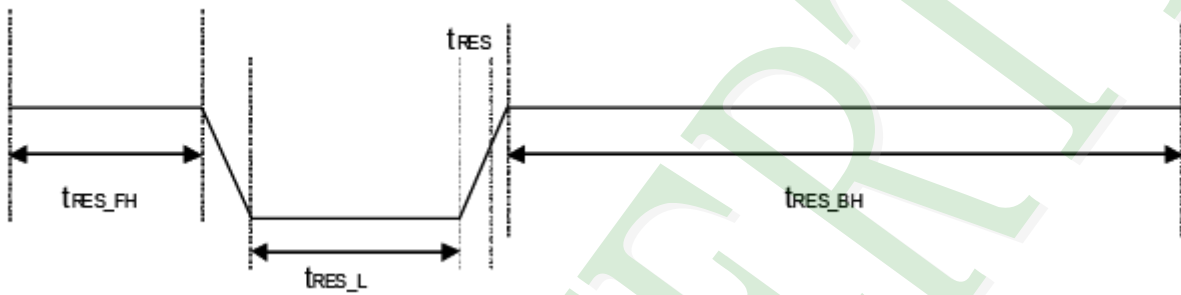

3. QUALITY ASSURANCE SYSTEM

3.1 Quality Assurance Flow Chart

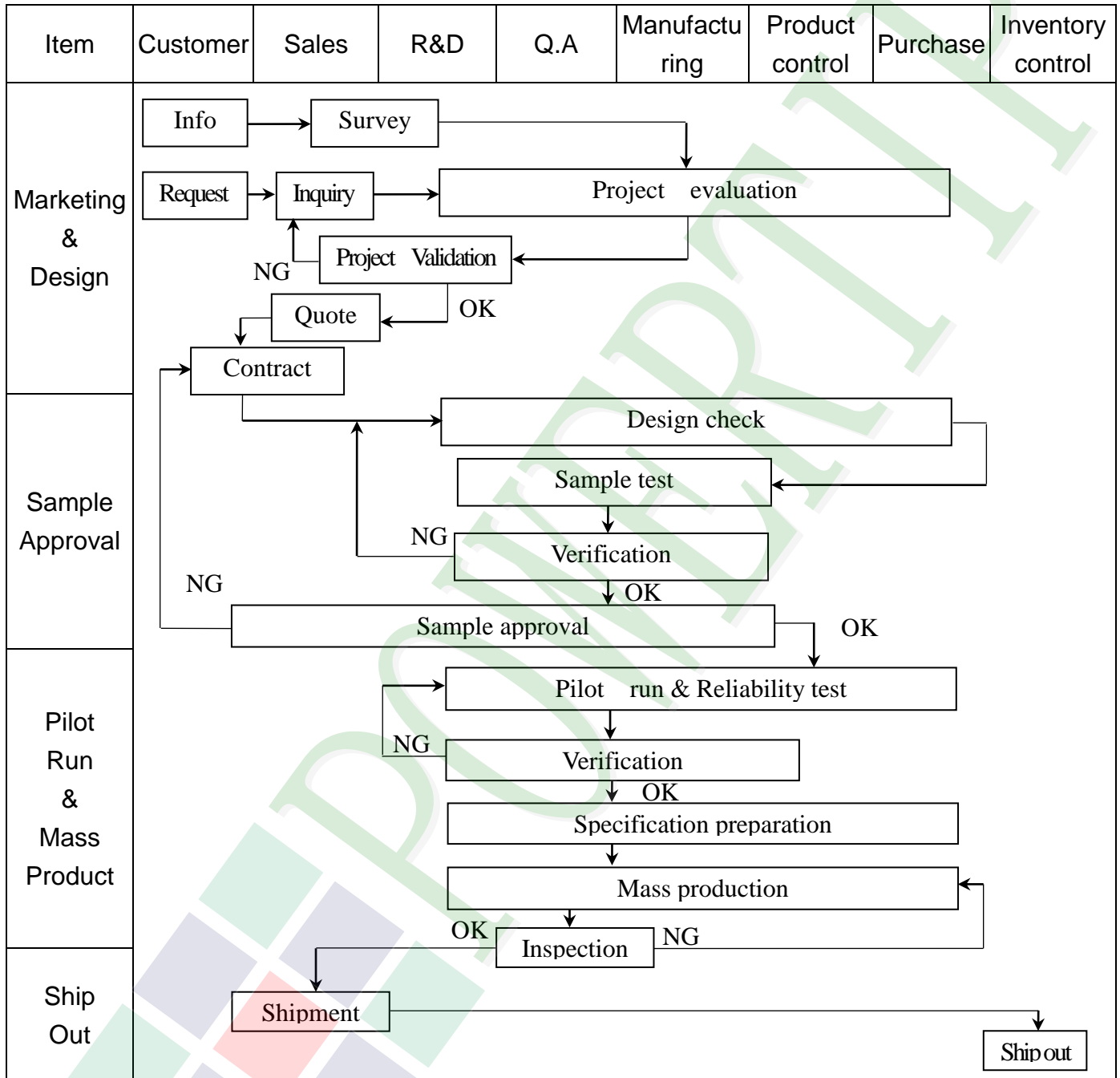

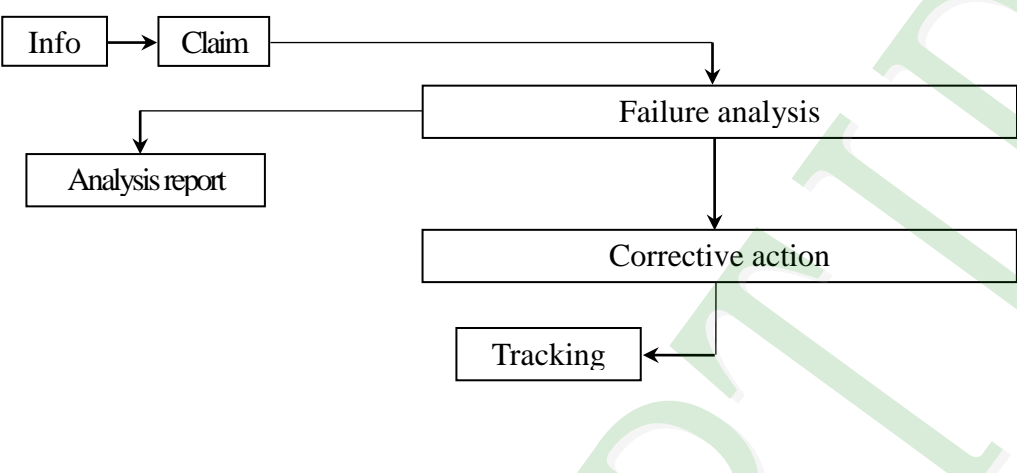
Item	Customer	Sales	R&D	Q.A	Manufacturing	Product control	Purchase	Inventory control
Sales Service	 <pre> graph TD Info[Info] --> Claim[Claim] Claim --> FA[Failure analysis] Claim --> AR[Analysis report] FA --> CA[Corrective action] CA --> Tracking[Tracking] </pre>							
Q.A Activity	1. ISO 9001 Maintenance Activities 3. Equipment calibration 5. Standardization Management				2. Process improvement proposal 4. Education And Training Activities			

3.2 Inspection Specification

- ◆ **Scope** : The document shall be applied to TFT-LCD Module for less than 3.5" (Ver.B01).
- ◆ **Inspection Standard** : MIL-STD-105E Table Normal Inspection Single Sampling Level II.
- ◆ **Equipment** : Gauge 、 MIL-STD 、 Powertip Tester 、 Sample
- ◆ **Defect Level** : Major Defect AQL : 0.4 ; Minor Defect AQL : 1.5
- ◆ **OUT Going Defect Level** : Sampling.
- ◆ **Standard of the product appearance test** :

a. Manner of appearance test :

- (1). The test best be under 20W×2 fluorescent light , and distance of view must be at 30 cm.
- (2). The test direction is base on about around 45° of vertical line.

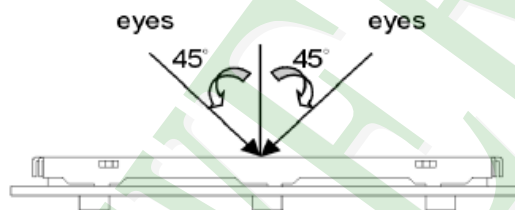

(3). Definition of area.

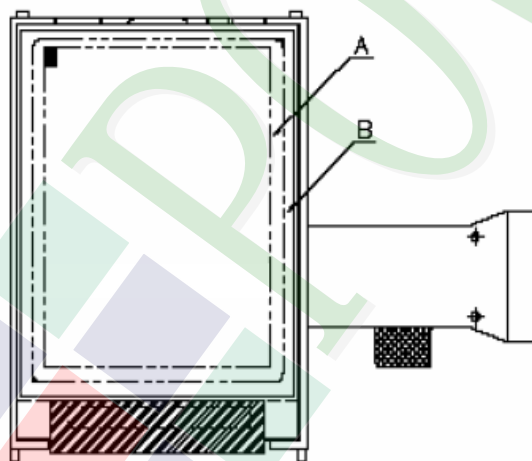

A area : viewing area

B area : Outside of viewing area

(4). Standard of inspection : (Unit : mm)

◆ Specification For TFT-LCD Module Less Than 3.5" :

(Ver.B01)

NO	Item	Criterion	Level												
01	Product condition	1. 1 The part number is inconsistent with work order of production.	Major												
		1. 2 Mixed product types.	Major												
		1. 3 Assembled in inverse direction.	Major												
02	Quantity	2. 1 The quantity is inconsistent with work order of production.	Major												
03	Outline dimension	3. 1 Product dimension and structure must conform to structure diagram.	Major												
04	Electrical Testing	4. 1 Missing line character and icon.	Major												
		4. 2 No function or no display.	Major												
		4. 3 Display malfunction.	Major												
		4. 4 LCD viewing angle defect.	Major												
		4. 5 Current consumption exceeds product specifications.	Major												
05	Dot defect (Bright dot 、 Dark dot) On -display	<table border="1" style="margin-left: auto; margin-right: auto;"> <thead> <tr> <th></th> <th>Item</th> <th>Acceptance (Q'ty)</th> </tr> </thead> <tbody> <tr> <td rowspan="4" style="text-align: center; vertical-align: middle;">Dot Defect</td> <td>Bright Dot</td> <td style="text-align: center;">≤ 2</td> </tr> <tr> <td>Dark Dot</td> <td style="text-align: center;">≤ 3</td> </tr> <tr> <td>Joint Dot</td> <td style="text-align: center;">≤ 2</td> </tr> <tr> <td>Total</td> <td style="text-align: center;">≤ 3</td> </tr> </tbody> </table> <p>5. 1 Inspection pattern : full white , full black , Red , Green and blue screens.</p> <p>5. 2 It is defined as dot defect if defect area $> 1/2$ dot.</p> <p>5. 3 The distance between two dot defect ≥ 5 mm.</p>		Item	Acceptance (Q'ty)	Dot Defect	Bright Dot	≤ 2	Dark Dot	≤ 3	Joint Dot	≤ 2	Total	≤ 3	Minor
	Item	Acceptance (Q'ty)													
Dot Defect	Bright Dot	≤ 2													
	Dark Dot	≤ 3													
	Joint Dot	≤ 2													
	Total	≤ 3													

◆ Specification For TFT-LCD Module Less Than 3.5" :

(Ver.B01)

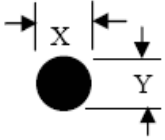
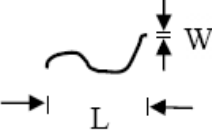
NO	Item	Criterion	Level																																								
06	<p>Black or white dot、scratch、contamination</p> <p>Round type</p>  <p>$\Phi = (x + y) / 2$</p> <p>Line type</p> 	<p>6.1 Round type (Non-display or display) :</p> <table border="1" data-bbox="550 436 1319 907"> <thead> <tr> <th rowspan="2">Dimension (diameter : Φ)</th> <th colspan="2">Acceptance (Q'ty)</th> </tr> <tr> <th>A area</th> <th>B area</th> </tr> </thead> <tbody> <tr> <td>$\Phi \leq 0.15$</td> <td colspan="2">Ignore</td> </tr> <tr> <td>$0.15 < \Phi \leq 0.20$</td> <td>2</td> <td rowspan="3">Ignore</td> </tr> <tr> <td>$0.20 < \Phi \leq 0.30$</td> <td>2</td> </tr> <tr> <td>$\Phi > 0.30$</td> <td>0</td> </tr> <tr> <td>Total</td> <td colspan="2">3</td> </tr> </tbody> </table> <p>6.2 Line type(Non-display or display) :</p> <table border="1" data-bbox="531 1025 1339 1458"> <thead> <tr> <th colspan="2">Dimension</th> <th colspan="2">Acceptance (Q'ty)</th> </tr> <tr> <th>Length (L)</th> <th>Width (W)</th> <th>A area</th> <th>B area</th> </tr> </thead> <tbody> <tr> <td>---</td> <td>$W \leq 0.03$</td> <td>Ignore</td> <td rowspan="3">Ignore</td> </tr> <tr> <td>$L \leq 5.0$</td> <td>$0.03 < W \leq 0.05$</td> <td>3</td> </tr> <tr> <td>---</td> <td>$W > 0.05$</td> <td>As round type</td> </tr> <tr> <td colspan="2">Total</td> <td colspan="2">3</td> </tr> </tbody> </table>	Dimension (diameter : Φ)	Acceptance (Q'ty)		A area	B area	$\Phi \leq 0.15$	Ignore		$0.15 < \Phi \leq 0.20$	2	Ignore	$0.20 < \Phi \leq 0.30$	2	$\Phi > 0.30$	0	Total	3		Dimension		Acceptance (Q'ty)		Length (L)	Width (W)	A area	B area	---	$W \leq 0.03$	Ignore	Ignore	$L \leq 5.0$	$0.03 < W \leq 0.05$	3	---	$W > 0.05$	As round type	Total		3		Minor
Dimension (diameter : Φ)	Acceptance (Q'ty)																																										
	A area	B area																																									
$\Phi \leq 0.15$	Ignore																																										
$0.15 < \Phi \leq 0.20$	2	Ignore																																									
$0.20 < \Phi \leq 0.30$	2																																										
$\Phi > 0.30$	0																																										
Total	3																																										
Dimension		Acceptance (Q'ty)																																									
Length (L)	Width (W)	A area	B area																																								
---	$W \leq 0.03$	Ignore	Ignore																																								
$L \leq 5.0$	$0.03 < W \leq 0.05$	3																																									
---	$W > 0.05$	As round type																																									
Total		3																																									
07	Polarizer Bubble	<table border="1" data-bbox="541 1509 1329 1935"> <thead> <tr> <th rowspan="2">Dimension (diameter : Φ)</th> <th colspan="2">Acceptance (Q'ty)</th> </tr> <tr> <th>A area</th> <th>B area</th> </tr> </thead> <tbody> <tr> <td>$\Phi \leq 0.20$</td> <td colspan="2">Ignore</td> </tr> <tr> <td>$0.20 < \Phi \leq 0.50$</td> <td>3</td> <td rowspan="2">Ignore</td> </tr> <tr> <td>$\Phi > 0.50$</td> <td>0</td> </tr> <tr> <td>Total</td> <td colspan="2">3</td> </tr> </tbody> </table>	Dimension (diameter : Φ)	Acceptance (Q'ty)		A area	B area	$\Phi \leq 0.20$	Ignore		$0.20 < \Phi \leq 0.50$	3	Ignore	$\Phi > 0.50$	0	Total	3		Minor																								
Dimension (diameter : Φ)	Acceptance (Q'ty)																																										
	A area	B area																																									
$\Phi \leq 0.20$	Ignore																																										
$0.20 < \Phi \leq 0.50$	3	Ignore																																									
$\Phi > 0.50$	0																																										
Total	3																																										

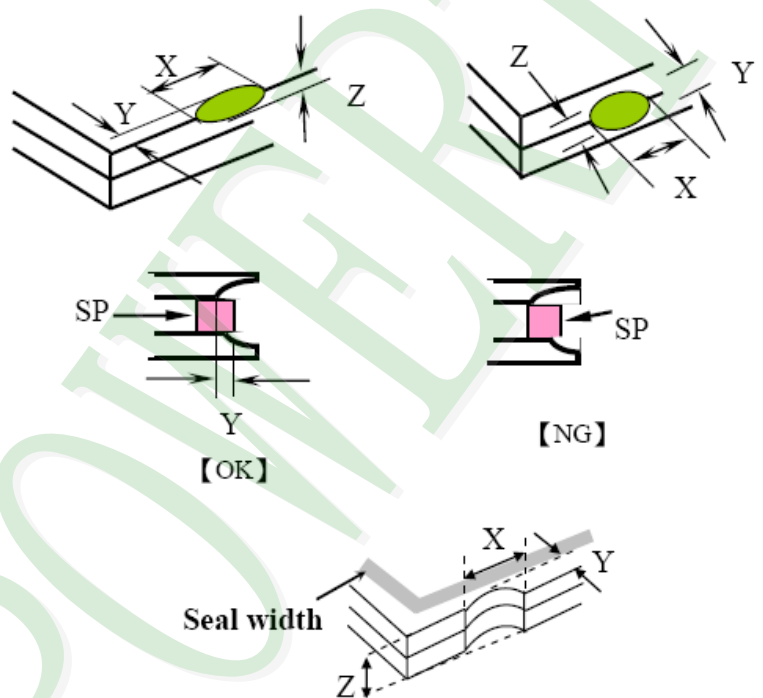
NO	Item	Criterion	Level						
08	The crack of glass	<p>Symbols :</p> <p>X : The length of crack Z : The thickness of crack t : The thickness of glass</p> <p>Y : The width of crack. W : terminal length a : LCD side length</p>	Minor						
		<p>8.1 General glass chip :</p> <p>8.1.1 Chip on panel surface and crack between panels:</p>  <table border="1" data-bbox="550 1500 1348 1803"> <thead> <tr> <th>X</th> <th>Y</th> <th>Z</th> </tr> </thead> <tbody> <tr> <td>$\leq a$</td> <td>Crack can't enter viewing area</td> <td>$\leq 1/2 t$</td> </tr> <tr> <td>$\leq a$</td> <td>Crack can't exceed the half of SP width.</td> <td>$1/2 t < Z \leq 2 t$</td> </tr> </tbody> </table>		X	Y	Z	$\leq a$	Crack can't enter viewing area	$\leq 1/2 t$
X	Y	Z							
$\leq a$	Crack can't enter viewing area	$\leq 1/2 t$							
$\leq a$	Crack can't exceed the half of SP width.	$1/2 t < Z \leq 2 t$							

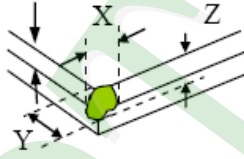
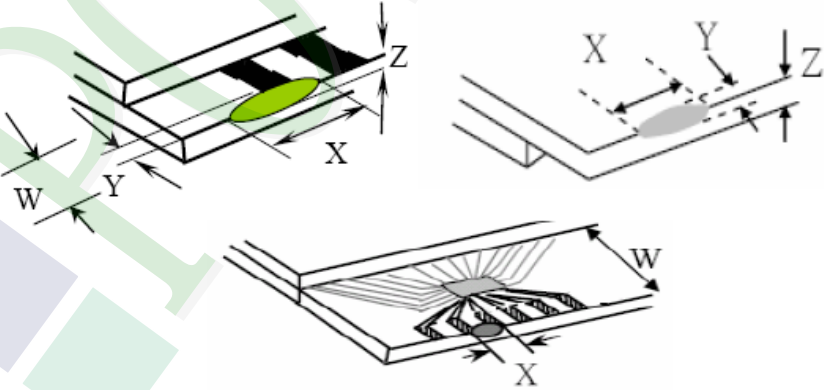
NO	Item	Criterion	Level												
08	The crack of glass	<p>Symbols :</p> <p>X : The length of crack Z : The thickness of crack t : The thickness of glass</p> <p>Y : The width of crack. W : terminal length a : LCD side length</p>	Minor												
		<p>8.1.2 Corner crack :</p>  <table border="1" data-bbox="531 799 1334 1099"> <thead> <tr> <th>X</th> <th>Y</th> <th>Z</th> </tr> </thead> <tbody> <tr> <td>$\leq 1/5 a$</td> <td>Crack can't enter viewing area</td> <td>$Z \leq 1/2 t$</td> </tr> <tr> <td>$\leq 1/5 a$</td> <td>Crack can't exceed the half of SP width.</td> <td>$1/2 t < Z \leq 2 t$</td> </tr> </tbody> </table>		X	Y	Z	$\leq 1/5 a$	Crack can't enter viewing area	$Z \leq 1/2 t$	$\leq 1/5 a$	Crack can't exceed the half of SP width.	$1/2 t < Z \leq 2 t$			
X	Y	Z													
$\leq 1/5 a$	Crack can't enter viewing area	$Z \leq 1/2 t$													
$\leq 1/5 a$	Crack can't exceed the half of SP width.	$1/2 t < Z \leq 2 t$													
		<p>8.2 Protrusion over terminal :</p> <p>8.2.1 Chip on electrode pad :</p>  <table border="1" data-bbox="568 1718 1342 1895"> <thead> <tr> <th></th> <th>X</th> <th>Y</th> <th>Z</th> </tr> </thead> <tbody> <tr> <td>Front</td> <td>$\leq a$</td> <td>$\leq 1/2 W$</td> <td>$\leq t$</td> </tr> <tr> <td>Back</td> <td>$\leq a$</td> <td>$\leq W$</td> <td>$\leq 1/2 t$</td> </tr> </tbody> </table>		X	Y	Z	Front	$\leq a$	$\leq 1/2 W$	$\leq t$	Back	$\leq a$	$\leq W$	$\leq 1/2 t$	
	X	Y	Z												
Front	$\leq a$	$\leq 1/2 W$	$\leq t$												
Back	$\leq a$	$\leq W$	$\leq 1/2 t$												

◆ Specification For TFT-LCD Module Less Than 3.5" :

(Ver.B01)

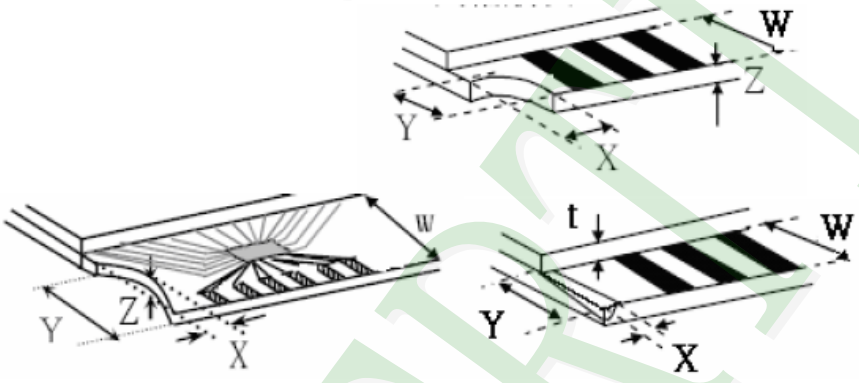
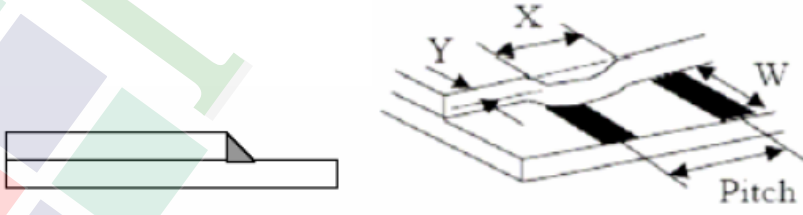
NO	Item	Criterion	Level												
08	The crack of glass	<p>Symbols :</p> <p>X : The length of crack Z : The thickness of crack t : The thickness of glass</p> <p>Y : The width of crack. W : terminal length a : LCD side length</p> <hr/> <p>8.2.2 Non-conductive portion :</p>  <table border="1" data-bbox="630 952 1252 1108"> <thead> <tr> <th>X</th> <th>Y</th> <th>Z</th> </tr> </thead> <tbody> <tr> <td>$\leq 1/3 a$</td> <td>$\leq W$</td> <td>$\leq t$</td> </tr> </tbody> </table> <p>⊙ If the chipped area touches the ITO terminal, over 2/3 of the ITO must remain and be inspected according to electrode terminal specifications.</p> <p>8.2.3 Glass remain :</p>  <table border="1" data-bbox="550 1747 1236 1870"> <thead> <tr> <th>X</th> <th>Y</th> <th>Z</th> </tr> </thead> <tbody> <tr> <td>$\leq a$</td> <td>$\leq 1/3 W$</td> <td>$\leq t$</td> </tr> </tbody> </table>	X	Y	Z	$\leq 1/3 a$	$\leq W$	$\leq t$	X	Y	Z	$\leq a$	$\leq 1/3 W$	$\leq t$	Minor
		X	Y	Z											
$\leq 1/3 a$	$\leq W$	$\leq t$													
X	Y	Z													
$\leq a$	$\leq 1/3 W$	$\leq t$													

◆ Specification For TFT-LCD Module Less Than 3.5" :

(Ver.B01)

NO	Item	Criterion	Level
09	Backlight elements	9. 1 Backlight can't work normally.	Major
		9. 2 Backlight doesn't light or color is wrong.	Major
		9. 3 Illumination source flickers when lit.	Major
10	General appearance	10. 1 Pin type 、 quantity 、 dimension must match type in structure diagram.	Major
		10. 2 No short circuits in components on PCB or FPC .	Major
		10. 3 Parts on PCB or FPC must be the same as on the production characteristic chart .There should be no wrong parts , missing parts or excess parts.	Major
		10. 4 Product packaging must the same as specified on packaging specification sheet.	Minor
		10. 5 The folding and peeled off in polarizer are not acceptable.	Minor
		10. 6 The PCB or FPC between B/L assembled distance(PCB or FPC) is ≤ 1.5 mm.	Minor

4. RELIABILITY TEST

4.1 Reliability Test Condition

(Ver.B01)

NO.	TEST ITEM	TEST CONDITION										
1	High Temperature Storage Test	Keep in +80 ±2°C 96 hrs Surrounding temperature, then storage at normal condition 4hrs.										
2	Low Temperature Storage Test	Keep in -30 ±2°C 96 hrs Surrounding temperature, then storage at normal condition 4hrs.										
3	High Temperature / High Humidity Storage Test	Keep in +60 °C / 90% R.H duration for 96 hrs Surrounding temperature, then storage at normal condition 4hrs. (Excluding the polarizer)										
4	Temperature Cycling Storage Test	<p style="text-align: center;"> $-30^{\circ}\text{C} \rightarrow +25^{\circ}\text{C} \rightarrow +80^{\circ}\text{C} \rightarrow +25^{\circ}\text{C}$ (30mins) (5mins) (30mins) (5mins) $\leftarrow \hspace{10em} \rightarrow$ 10 Cycle </p> <p>Surrounding temperature, then storage at normal condition 4hrs.</p>										
5	ESD Test	Air Discharge: Apply 4 KV with 5 times Discharge for each polarity +/-										
		Contact Discharge: Apply 2 KV with 5 times discharge for each polarity +/-										
		<ol style="list-style-type: none"> Temperature ambience : 15°C ~ 35°C Humidity relative : 30% ~ 60% Energy Storage Capacitance(Cs+Cd) : 150pF±10% Discharge Resistance(Rd) : 330Ω±10% Discharge, mode of operation : Single Discharge (time between successive discharges at least 1 sec) (Tolerance if the output voltage indication : ±5%) 										
6	Vibration Test (Packaged)	<ol style="list-style-type: none"> Sine wave 10~55 Hz frequency (1 min/sweep) The amplitude of vibration : 1.5 mm Each direction (X、Y、Z) duration for 2 Hrs 										
7	Drop Test (Packaged)	<table border="1" style="width: 100%; text-align: center;"> <thead> <tr> <th>Packing Weight (Kg)</th> <th>Drop Height (cm)</th> </tr> </thead> <tbody> <tr> <td>0 ~ 45.4</td> <td>122</td> </tr> <tr> <td>45.4 ~ 90.8</td> <td>76</td> </tr> <tr> <td>90.8 ~ 454</td> <td>61</td> </tr> <tr> <td>Over 454</td> <td>46</td> </tr> </tbody> </table>	Packing Weight (Kg)	Drop Height (cm)	0 ~ 45.4	122	45.4 ~ 90.8	76	90.8 ~ 454	61	Over 454	46
		Packing Weight (Kg)	Drop Height (cm)									
0 ~ 45.4	122											
45.4 ~ 90.8	76											
90.8 ~ 454	61											
Over 454	46											
		Drop Direction : ※1 corner / 3 edges / 6 sides each 1time										

5. PRECAUTION RELATING PRODUCT HANDLING

5.1 SAFETY

- 5.1.1 If the LCD panel breaks , be careful not to get the liquid crystal to touch your skin.
- 5.1.2 If the liquid crystal touches your skin or clothes , please wash it off immediately by using soap and water.

5.2 HANDLING

- 5.2.1 Avoid any strong mechanical shock which can break the glass.
- 5.2.2 Avoid static electricity which can damage the CMOS LSI—When working with the module , be sure to ground your body and any electrical equipment you may be using.
- 5.2.3 Do not remove the panel or frame from the module.
- 5.2.4 The polarizing plate of the display is very fragile. So , please handle it very carefully ,do not touch , push or rub the exposed polarizing with anything harder than an HB pencil lead (glass , tweezers , etc.)
- 5.2.5 Do not wipe the polarizing plate with a dry cloth , as it may easily scratch the surface of plate.
- 5.2.6 Do not touch the display area with bare hands , this will stain the display area.
- 5.2.7 Do not use ketonics solvent & aromatic solvent. Use with a soft cloth soaked with a cleaning naphtha solvent.
- 5.2.8 To control temperature and time of soldering is $320\pm 10^{\circ}\text{C}$ and 3-5 sec.
- 5.2.9 To avoid liquid (include organic solvent) stained on LCM .

5.3 STORAGE

- 5.3.1 Store the panel or module in a dark place where the temperature is $25^{\circ}\text{C} \pm 5^{\circ}\text{C}$ and the humidity is below 65% RH.
- 5.3.2 Do not place the module near organics solvents or corrosive gases.
- 5.3.3 Do not crush , shake , or jolt the module.

5.4 TERMS OF WARRANTY

- 5.4.1 Applicable warrant period
The period is within thirteen months since the date of shipping out under normal using and storage conditions.
- 5.4.2 Unaccepted responsibility
This product has been manufactured to your company's specification as a part for use in your company's general electronic products. It is guaranteed to perform according to delivery specifications. For any other use apart from general electronic equipment , we cannot take responsibility if the product is used in nuclear power control equipment , aerospace equipment , fire and security systems or any other applications in which there is a direct risk to human life and where extremely high levels of reliability are required.

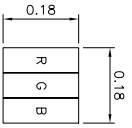
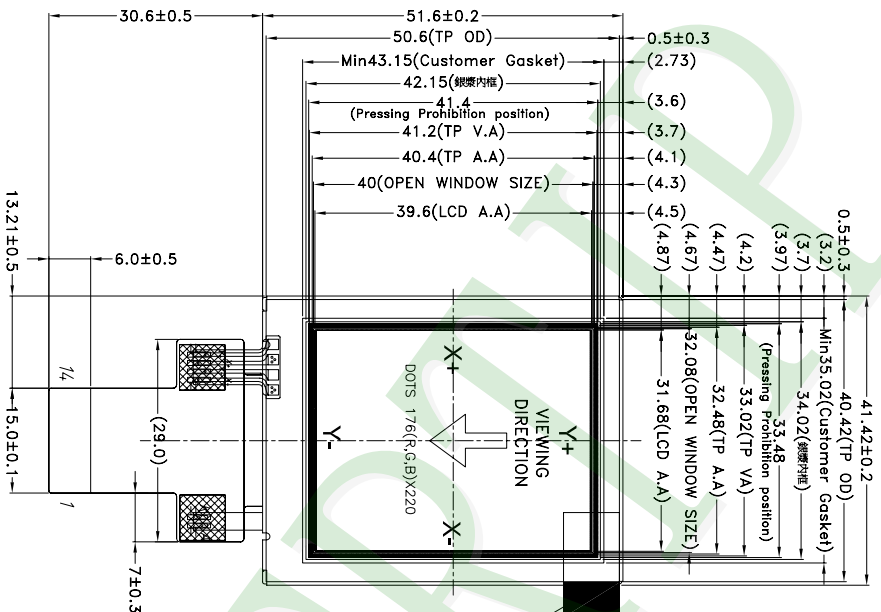

SCALE: 50X

- NOTE:
- LCD TYPE: Color TFT, POSITIVE / TRANSMISSIVE
 - VIEW DIRECTION: 12.0° CLOCK
 - Top: $-20 \sim 70^\circ \text{C}$ Tst: $-30 \sim 80^\circ \text{C}$
 - (---): Reference dimension
 - RoHS Compliance
 - The tolerance unless classified $\pm 0.2\text{mm}$
 - R for not assigned 0.5mm
 - FPC PIN DESIGN REFER TO: Cvilux: CF07141DOR0(E&T)

007						
006						
005						
004						
003						
002						
001	NEW DRAWING	Air	2014/07/23			
REV	REV BY	REVISER	DATE			

PART NO: PH176220T062-LAB01		DRAWING NAME: JLMD-PH176220T062-LAB01		TITLE: LCM DRAWING	
Design	Air	Check	Terry	Approve	Ryan
Unit	MM	Scale	1:1	Page	1/1
Surface	Material	Thickness	Quantity		
久正光電股份有限公司		POWER TIP TECHNOLOGY CORPORATION			
Tolerance (mm)	Precision Level				
1 ~ 4	-				
4 ~ 16	-				
16 ~ 63	-				
63 ~ 250	-				
250 ~ 1000	-				

Bill of material

Item	Description of the Specification	Quantity	Supplier	3 rd Party Report Number	
LCD	CT020TN01 ,0.5t	1	Century Technology (Shenzhen) Corporation Limited	CE 2014 14364	
IC	ILI9225G	1	ILITEK	CE 2014 A0705	
Top Polarizer	SLP-5215EWV-T	1	SUNNYPOL	SCL01G00008498005C	
Bottom Polarizer	SLP-5215EWV-T	1	SUNNYPOL	SCL01G00008498005C	
FPC	224293T250	1	CROWD TOP	CE 2014 34804 CANEC1314311901 RHS01F018722002E	
ACF	CP3020F3	0.0115 m	SONY	JP 2014 060341	
	CP9731SB	0.021m	SONY	JP 2014 060341	
Silicone	SE9187L	0.0539g	Dowcorning	CE 2015 16007	
Backlight	White LED	1	AKENT	CANEC1317350404 CE 2014 11563 CE 2013 C3665A	
Frame	SUS 201,0.15t	1	AKENT	CANML1400534701	
TOUCH PANEL	4-line resistance touch panel.ITO film: NITTO V270	1	RAECE	CANML14075420802 TWNC00391272 RHS05G21347001 RHS01F024791002E SHAEC1324951603 A01 CE 2014 15508	
PULL TAPE	15*8	1	YONGHE	XMN14-002879-02	
KAPTION TAPE	6.5*6.5	2	TECH-SUN	CE 2014 14373	
TAPE	20*2.5	1	TECH-SUN	CE 2014 41677	
Packing Material	TRAY	352*260*13.8	0.0729	JINZHONG	ECL01G014203001C
	POF	350*0.015	0.0031	LIANXING	CANEC1413558001
	Product Box	393*274*68	0.0104	YIMAXIAN	SHAEC1421654601
	Polyon board	550*393*20	0.0034	RONGSHENG	SHAEC1409232402
	Carton	570*410*265	0.0017	YIMAXIAN	SHAEC1421654601

Ver.002

Documents NO. JPKG-PH176220T062-LAB01

LCM包裝規格書

LCM Packaging Specifications (For Tray)

Approve	Check	Contact
Ryan	Terry	Air

1. 包裝材料規格表 (Packaging Material) : (per carton)

No.	Item	Model	Dimensions (mm)	1Pcs Weight	Quantity	Total Weight
1	成品 (LCM)	PH176220T062-LAB01	41.42 X 51.6 X 4.7	0.013	13824	179.712
2	銀色防ESD屏蔽袋 (1) ESD Bag	BAG0000000027	510 X 430	0.0303	144	4.3632
3	TRAY 盤 (2)Tray	TY00000000274	352 X 260 X 13.8	0.1	1008	100.8
4	內盒(3)Product Box	BX36627063ABBA	393 X 274 X 68	0.2692	144	38.7648
5	保利龍板(4)Polylon board	OTPLB00PL08ABA	550 X 393 X 20	0.0284	48	1.3632
6	外紙箱(5)Carton	BX57041027CCBA	570 X 410 X 265	1.26	24	30.24
7	棧板(6)PALLET	OTPALLET00003	1300 X 1100 X 140	10.5	1	10.5
8						

2. 一整箱總重量 (Total LCD Weight in carton) : 365.74 Kg±10%

3. 單箱數量規格表 (Packaging Specifications and Quantity) :

(1) LCM quantity per box : no per tray	16	x no of tray	6	=	96
(2) Total LCM quantity in carton : quantity per box	96	x no of boxes	6	=	576
(3) Total LCM quantity in pallet : quantity per carton	576	x no. of cartons	24	=	13824

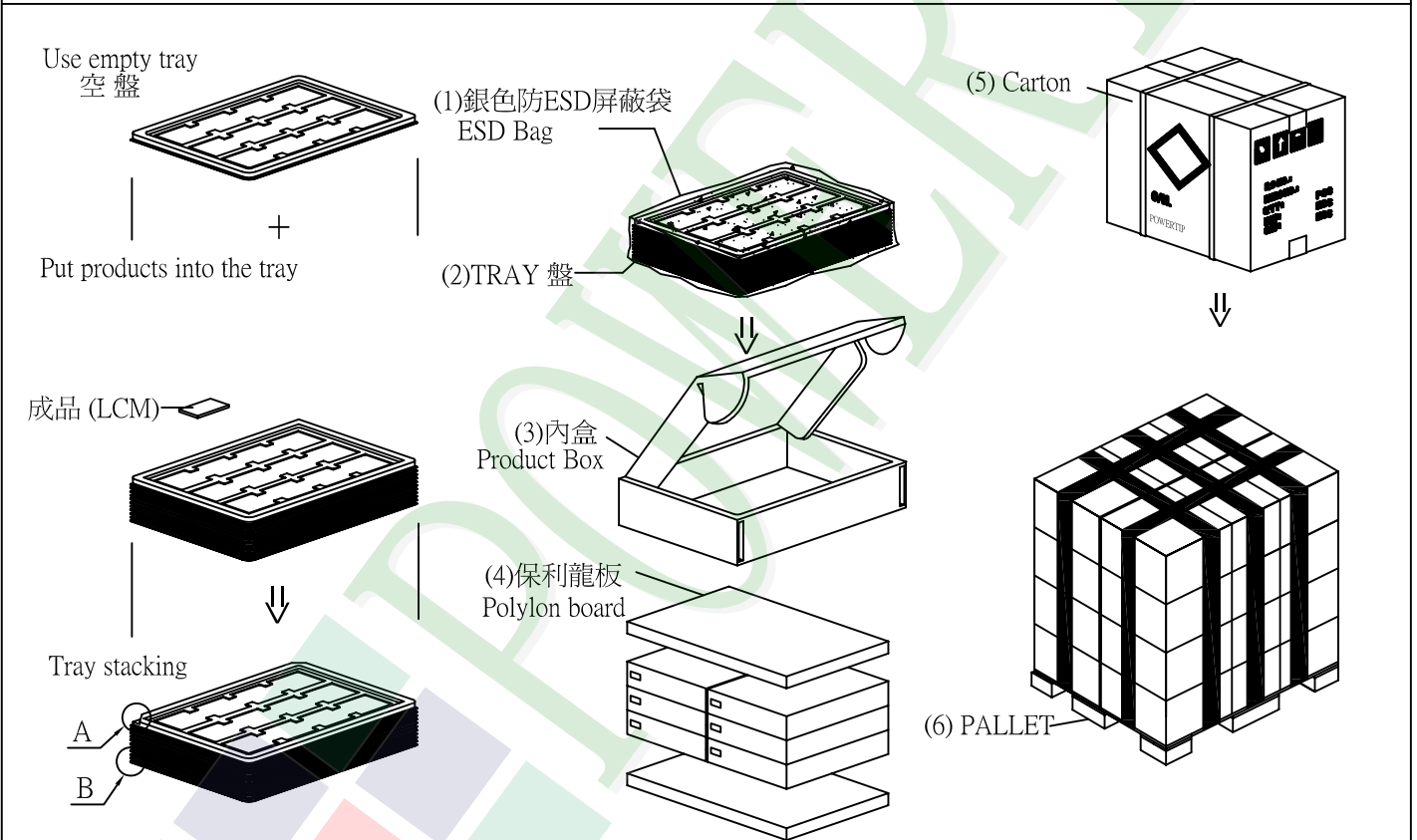

特 記 事 項 (REMARK)

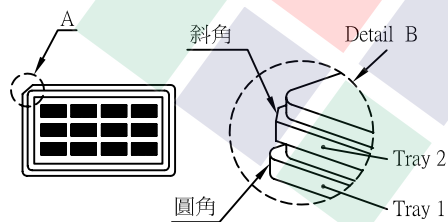

4. TRAY 盤相疊時, 需旋轉180度, 請詳見B視圖
Rotate tray 180 degrees and place on top of stack.
Check the tray stack using Fig. B.