



## SPECIFICATIONS

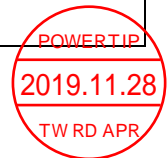
<b>CUSTOMER</b>	:	_____
<b>SAMPLE CODE</b>	:	SH480272T005-IHC03
<b>MASS PRODUCTION CODE</b>	:	PH480272T005-IHC03
<b>SAMPLE VERSION</b>	:	01
<b>SPECIFICATIONS EDITION</b>	:	004
<b>DRAWING NO. (Ver.)</b>	:	LMD-PH480272T005-IHC03 (Ver.001)
<b>PACKAGING NO. (Ver.)</b>	:	PKG-PH480272T005-IHC03 (Ver.001)

**Customer Approved**

**Date:** \_\_\_\_\_

Approved	Checked	Designer
黃秋源 <b>Oliver Huang</b>	石建莊 <b>Stone Shin</b>	王聖硯 <b>Stephen Wang</b>



- Preliminary specification for design input
- Specification for sample approval

### POWERTIP TECH. CORP.

**Headquarters:**

No.8, 6<sup>th</sup> Road, Taichung Industrial Park,  
Taichung, Taiwan  
台中市 407 工業區六路 8 號

TEL: 886-4-2355-8168  
FAX: 886-4-2355-8166

E-mail: [sales@powertip.com.tw](mailto:sales@powertip.com.tw)  
[Http://www.powertip.com.tw](http://www.powertip.com.tw)



## Contents

### 1. SPECIFICATIONS

- 1.1 Features
- 1.2 Mechanical Specifications
- 1.3 Absolute Maximum Ratings
- 1.4 DC Electrical Characteristics
- 1.5 Optical Characteristics
- 1.6 Backlight Characteristics
- 1.7 Touch Panel Characteristics
- 1.8 HYCON I<sup>2</sup>C Sensitivity command

### 2. MODULE STRUCTURE

- 2.1 Counter Drawing
- 2.2 Interface Pin Description
- 2.3 HDMI Characteristics

### 3. QUALITY ASSURANCE SYSTEM

- 3.1 Quality Assurance Flow Chart
- 3.2 Inspection Specification

### 4. RELIABILITY TEST

- 4.1 Reliability Test Condition

### 5. PRECAUTION RELATING PRODUCT HANDLING

- 5.1 Safety
- 5.2 Handling
- 5.3 Storage
- 5.4 Terms of Warranty

Appendix : LCM Drawing  
LCM Packaging Specifications

## 1. SPECIFICATIONS

### 1.1 Features

Item	Standard Value
Display Resolution	480 *3 (RGB) * 272 Dots
LCD Type	a-Si TFT , Normally white , Transmissive type
Screen Size(inch)	4.3 inch
Viewing Direction	6 O'clock
Color Configuration	RGB - Strip
Touch Panel	Projective Capacitive Touch Panel USB HID Touch
Weight	103.4 g
Backlight Type	White LED B/L
Interface	HDMI
Controller/Driver IC	HYCON 4635
ROHS	THIS PRODUCT CONFORMS THE ROHS OF PTC Detail information please refer website : <a href="http://www.powertip.com.tw/news_detail.php?Key=1&amp;cID=1">http://www.powertip.com.tw/news_detail.php?Key=1&amp;cID=1</a>

### 1.2 Mechanical Specifications

Item	Standard Value	Unit
Outline Dimension	105.5 (W) * 67.2 (L) * 15.76 (H)	mm

#### LCD panel

Item	Standard Value	Unit
Active Area	95.04 (W) * 53.856 (L)	mm

#### Touch Panel

Item	Standard Value	Unit
Viewing Area	97.9 (W) * 56.2 (L)	mm

Note : For detailed information please refer to LCM drawing.

### 1.3 Absolute Maximum Ratings

#### Module

Item	Symbol	Condition	Min.	Max.	Unit
Power Supply for Digital Circuit	V <sub>Bus</sub>	GND=0V	-0.3	+6.0	V
Operating Temperature	T <sub>OP</sub> (Ts)	Note 1	-20	+70	°C
Storage Temperature	T <sub>ST</sub> (Ta)	Note 2	-30	+80	°C

Note 1 : Ts is the temperature of panel's surface

Note 2 : Ta is the ambient temperature of samples

The absolute maximum rating values of this product are not allowed to be exceeded at any times. Should a module be used with any of the absolute maximum ratings exceeded, the characteristics of the module may not be recovered, or in an extreme case, the module may be permanently destroyed.

### 1.4 DC Electrical Characteristics

#### Module

GND = 0V, Ta = 25°C

Item	Symbol	Min.	Typ.	Max.	Unit	Remark
Input Signal Voltage	V <sub>Bus</sub>	4.75	5.0	5.25	V	Note
Supply Current	I <sub>VBus</sub>	350	370	450	mA	Pattern = Full Display

**Note1:** The customer has to check the input current is greater than 1.5A.

**Note2:** Supply voltage which is included backlight drive.

**Note3:** Maximum current for RGB screen, full display.

## 1.5 Optical Characteristics

### TFT LCD Module

Ta=25°C

Item		Symbol	Condition	Min.	Typ.	Max.	unit	
Response Time	Rise	Tr	Ta = 25°C θX, θY = 0°	-	10	20	ms	Note 2
	Fall	Tf		-	15	30		
Viewing Angle	Top	θY+	CR ≥ 10	-	60	-	Deg.	Note 4
	Bottom	θY-		-	60	-		
	Left	θX-		-	60	-		
	Right	θX+		-	60	-		
Contrast Ratio		CR		500	600	-	-	Note 3
Color of CIE Coordinate ( With B/L )	White	X	Ta = 25°C θX , θY = 0°	0.25	0.30	0.35	-	Note1
		Y		0.29	0.34	0.39		
	Red	X		0.51	0.59	0.64		
		Y		0.31	0.36	0.41		
	Green	X		0.28	0.33	0.38		
		Y		0.53	0.58	0.63		
	Blue	X		0.10	0.15	0.20		
		Y		0.05	0.10	0.15		
Average Brightness Pattern=White Display ( With LCD ) *1		IV	V <sub>Bus</sub> =5.0V PWM="High" (Duty=100%)	680	850	-	cd/m <sup>2</sup>	Note1
Uniformity ( With LCD ) *2		△B		70	-	-	%	Note1

Note 1:

\*1 :  $\Delta B = B(\text{min}) / B(\text{max}) * 100\%$

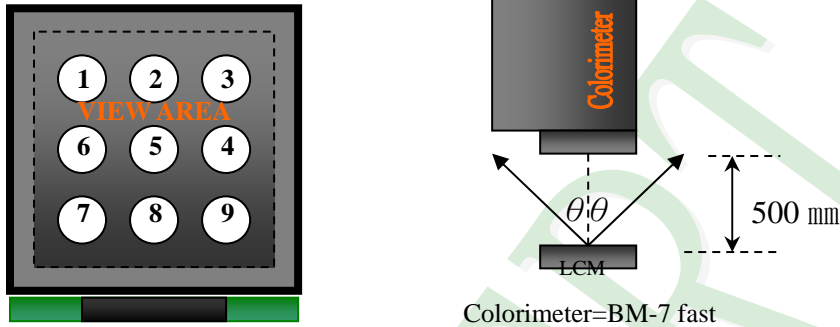
\*2 : Measurement Condition for Optical Characteristics:

a : Environment:  $25^{\circ}\text{C} \pm 5^{\circ}\text{C}$  /  $60 \pm 20\% \text{R.H}$  , no wind , dark room below 10 Lux at typical lamp current and typical operating frequency.

b : Measurement Distance:  $500 \pm 50 \text{ mm}$  , ( $\theta = 0^{\circ}$ )

c : Equipment: TOPCON BM-7 fast , (field  $1^{\circ}$ ) , after 10 minutes operation.

d : The uncertainty of the C.I.E coordinate measurement  $\pm 0.01$  , Average Brightness  $\pm 4\%$



To be measured at the center area of panel with a viewing cone of  $1^{\circ}$  by Topcon luminance meter BM-7, after 10 minutes operation (module)

Note2: Definition of response time:

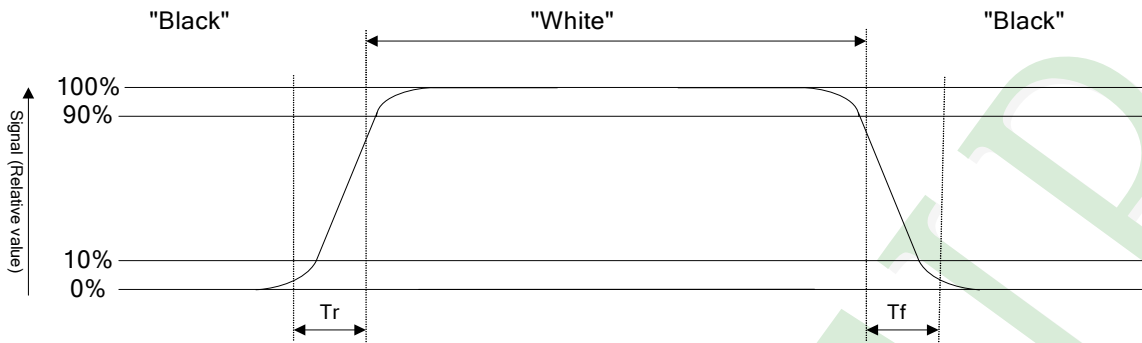
The output signals of photo detector are measured when the input signals are changed from "black" to "white"(falling time) and from "white" to "black"(rising time), respectively. The response time is defined as the time interval between the 10% and 90% of Amplitudes.

Refer to figure as below:

Normally White



### Normally Black



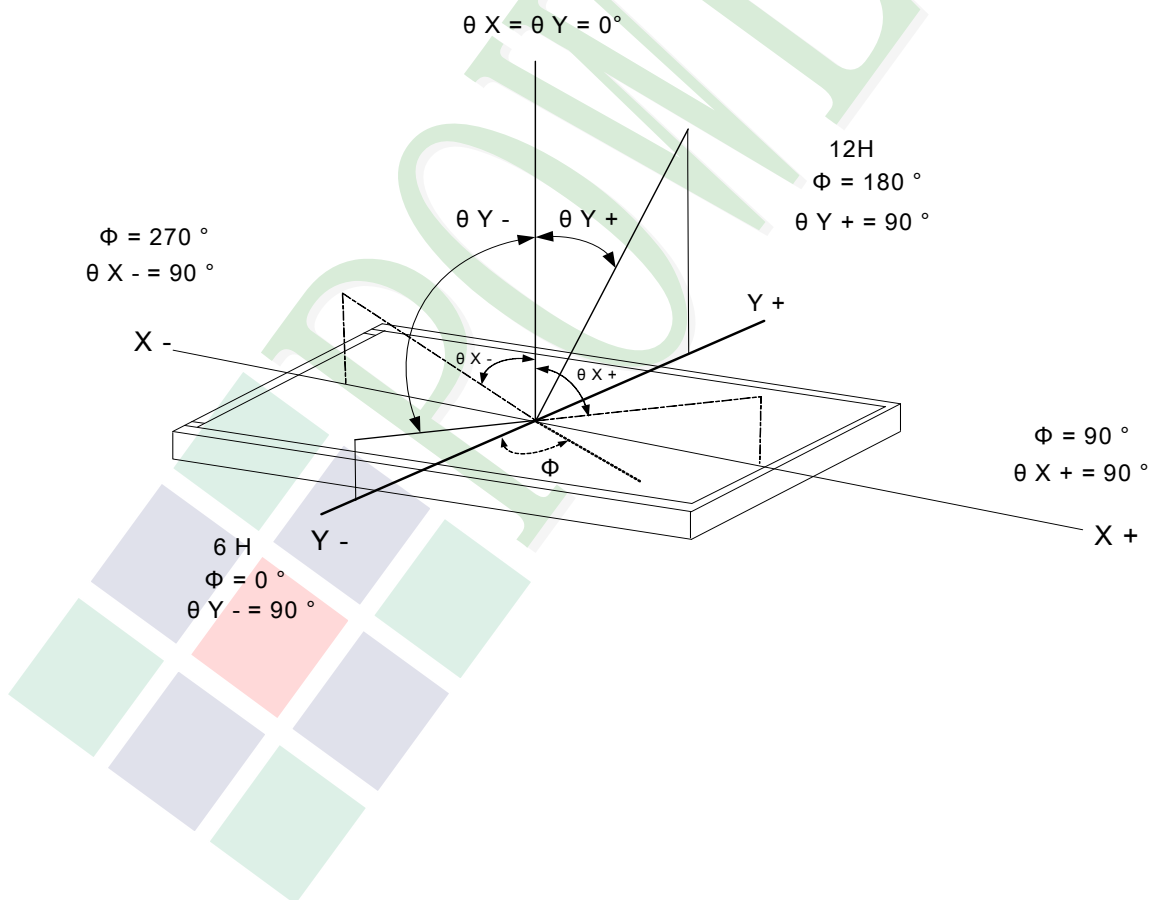
Note3: Definition of contrast ratio:

Contrast ratio is calculated with the following formula

$$\text{Contrast ratio (CR)} = \frac{\text{Photo detector output when LCD is at "White" state}}{\text{Photo detector output when LCD is at "Black" state}}$$

Note4: Definition of viewing angle:

Refer to figure as below:





## 1.6 Backlight Characteristics

### Maximum Ratings

Item	Symbol	Min.	Max.	Unit	Remark
LED Forward Current	$I_F$	30		mA	One LED
LED Reverse Voltage	$V_R$	5		V	
Power Dissipation	$P_D$	1224		mW	

### Electrical / Optical Characteristics

Item	Symbol	Condition	Min.	Typ.	Max.	Unit	Remark
Forward Voltage	$V_F$	$I_F=40\text{mA}$	17.6	19.2	20.4	V	Note1
LED Life Time	-		50000	-	-	hr	Note2
Color	White						

Note 1: The LED Supply Voltage is defined by the number of LED at  $T_a=25\text{ }^\circ\text{C}$ .

Note 2: The "LED life time" is defined as the module brightness decrease to 50% original brightness at  $T_a=25\text{ }^\circ\text{C}$  and  $I_L=40\text{ mA}$ . The LED life time could be decreased if operating  $I_L$  is larger than 40 mA.



## 1.7 Touch Panel Characteristics

### Features

Item	Standard Value
Touch Panel Size	4.3"
Touch Type	Projective Capacitive Touch Panel
Input Method	Finger / 5 Points Touch
Interface	I <sup>2</sup> C
IC	HYCON4635
I <sup>2</sup> C Address	0x38 (7-bit)

### I<sup>2</sup>C Address

Bit 7	Bit 6	Bit 5	Bit 4	Bit 3	Bit 2	Bit 1	Bit 0
0	1	1	1	0	0	0	R/W

Bit 0: 0 for Write / 1 for Read

### Mechanical Specifications

Item	Standard Value	Unit
Active Area	98.1 (W) * 56.9 (L)	mm
Number of Sensing Channel	18 * 10	

### Absolute Maximum Ratings

Item	Symbol	Condition	Min.	Max.	Unit
Supply Voltage	TP_VDD	-	-0.3	+6.0	V
Operating Temperature	T <sub>OP</sub>	-	-20	+70	°C
Storage Temperature	T <sub>ST</sub>	-	-30	+80	°C

### DC Electrical Characteristics

Item	Symbol	Condition	Min.	Typ.	Max.	Unit
Power Supply Voltage	TP_VDD	-	-	3.3	-	V

### Touch Panel IC Read/Write description & Register Mapping

Reference: HYCON Touch Driver Porting Reference Guide.

## 1.8 HYCON I<sup>2</sup>C Sensitivity command:

Address	Register description	R/W	Bit7	Bit6	Bit5	Bit4	Bit3	Bit2	Bit1	Bit0
0x92	GAIN	R/W	Sensitivity setting, setting range : 0--5							

### Application reference:

Register 0x92=02(Default)      without cover lens

### Caution!

At different cover lens thickness can lead to touch Sensitivity changed (e.g. ghost-touches).  
 Therefore, the touch needs to be thoroughly tested in the target application.  
 PTC application design suggestion is only for reference, please adjust based on your final design.

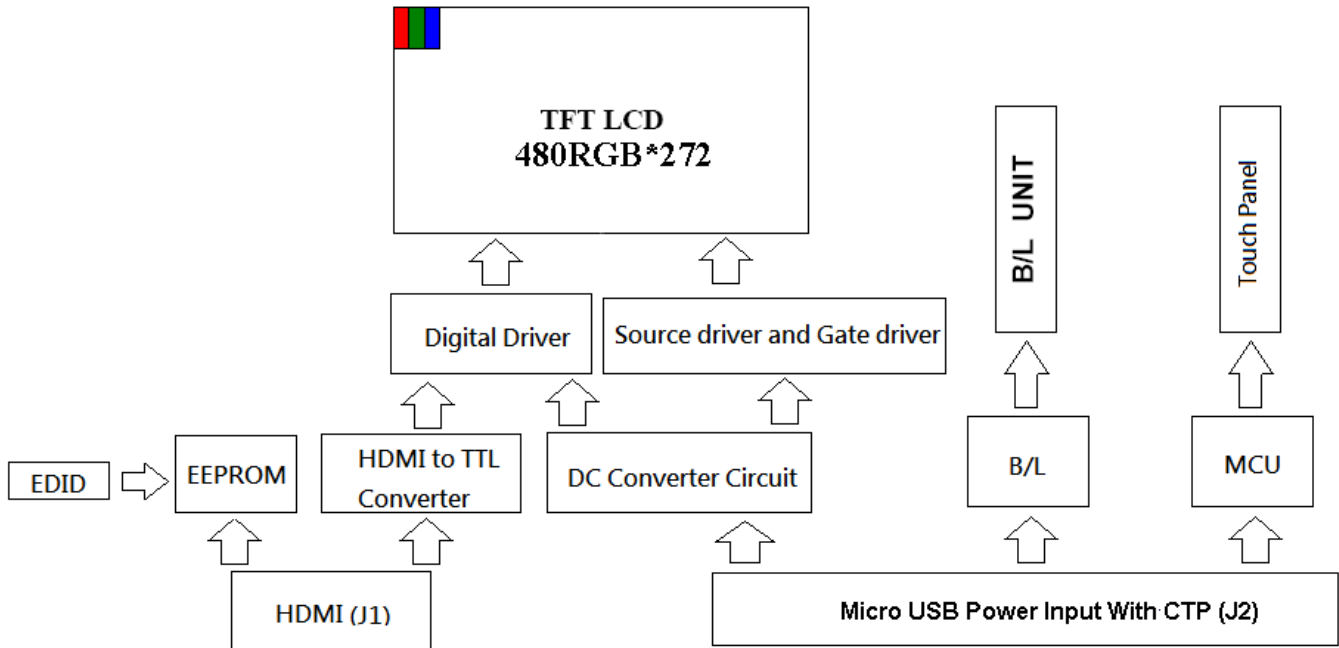
## 2. MODULE STRUCTURE

### 2.1 Counter Drawing

#### 2.1.1 LCM Mechanical Diagram

\* See Appendix

#### 2.1.2 Block Diagram



## 2.2 Interface Pin Description

### 2.2.1 (J1:HDMI 1.3 A type Interface)

Pin#	Name	Description
1	TX2+	TMDS Data 2+
2	TX2 Shield	TMDS Data 2 Shield
3	TX2-	TMDS Data 2-
4	TX1+	TMDS Data 1+
5	TX1 Shield	TMDS Data 1 Shield
6	TX1-	TMDS Data 1-
7	TX0+	TMDS Data 0+
8	TX0 Shield	TMDS Data 0 Shield
9	TX0-	TMDS Data 0-
10	TXC+	TMDS Clock+
11	TXC Shield	TMDS Clock Shield
12	TXC-	TMDS Clock-
13	CEC	CEC
14	NC	No connection
15	SCL	Serial Clock for DDC
16	SDA	Serial Data for DDC
17	GND	Power ground
18	V5V	+5V Power
19	Hot Plug Detect	Hot Plug Detect

### 2.2.2 (J2:Micro USB Power Input & Capacitive Touch Panel Interface)

Pin#	Name	Description
1	VBus	VBus 4.75V-5.25V
2	D-	Data-
3	D+	Data+
4	ID	No connection
5	GND	Power ground.

## 2.3 HDMI Characteristics

### 2.3.1 Signal DC&AC Characteristics

#### DC ELECTRICAL CHARACTERISTICS

over operating free-air temperature range (unless otherwise noted)

PARAMETER	TEST CONDITIONS	MIN	TYP	MAX	UNIT
V <sub>ID</sub>	Analog input differential voltage <sup>(1)</sup>	75		1200	mV
V <sub>IC</sub>	Analog input common-mode voltage <sup>(1)</sup>	AV <sub>DD</sub> - 300		AV <sub>DD</sub> - 37	mV
V <sub>I(OC)</sub>	Open-circuit analog input voltage	AV <sub>DD</sub> - 10		AV <sub>DD</sub> + 10	mV
I <sub>DD(2PIX)</sub>	Normal 2-pix/clock power supply current <sup>(2)</sup>	ODCK = 82.5 MHz, 2-pix/clock		370	mA
I <sub>PD</sub>	Power-down current <sup>(3)</sup>	$\overline{PD}$ = low		10	mA
I <sub>PDO</sub>	Output drive power-down current <sup>(3)</sup>	$\overline{PDO}$ = low		35	mA

(1) Specified as dc characteristic with no overshoot or undershoot

(2) Alternating 2-pixel black/2-pixel white pattern. ST = high,  $\overline{STAG}$  = high, QE[23:0] and QO[23:0] C<sub>L</sub> = 10 pF.

(3) Analog inputs are open circuit (transmitter is disconnected from TFP401/401A).

#### AC ELECTRICAL CHARACTERISTICS

over recommended operating free-air temperature range (unless otherwise noted)

PARAMETER	TEST CONDITIONS	MIN	TYP	MAX	UNIT
V <sub>ID(2)</sub>	Differential input sensitivity <sup>(1)</sup>	150		1560	mV <sub>p-p</sub>
t <sub>ps</sub>	Analog input intra-pair (+ to -) differential skew <sup>(2)</sup>			0.4	t <sub>bit</sub> <sup>(3)</sup>
t <sub>cos</sub>	Analog input inter-pair or channel-to-channel skew <sup>(2)</sup>			1	t <sub>pix</sub> <sup>(4)</sup>
t <sub>jitter</sub>	Worst-case differential input clock jitter tolerance <sup>(2)(5)</sup>	50			ps
t <sub>f1</sub>	Fall time of data and control signals <sup>(6)(7)</sup>	ST = low, C <sub>L</sub> = 5 pF		2.4	ns
		ST = high, C <sub>L</sub> = 10 pF		1.9	
t <sub>r1</sub>	Rise time of data and control signals <sup>(6)(7)</sup>	ST = low, C <sub>L</sub> = 5 pF		2.4	ns
		ST = high, C <sub>L</sub> = 10 pF		1.9	
t <sub>r2</sub>	Rise time of ODCK clock <sup>(6)</sup>	ST = low, C <sub>L</sub> = 5 pF		2.4	ns
		ST = high, C <sub>L</sub> = 10 pF		1.9	
t <sub>f2</sub>	Fall time of ODCK clock <sup>(6)</sup>	ST = low, C <sub>L</sub> = 5 pF		2.4	ns
		ST = high, C <sub>L</sub> = 10 pF		1.9	
t <sub>su1</sub>	Setup time, data and control signal to falling edge of ODCK	1 pixel/clock, PIXS = low, OCK_INV = low		1.8	ns
		2 pixel/clock, PIXS = high, STAG = high, OCK_INV = low		3.8	
		2 pixel and STAG, PIXS = high, STAG = low, OCK_INV = low		0.7	
t <sub>h1</sub>	Hold time, data and control signal to falling edge of ODCK	1 pixel/clock, PIXS = low, OCK_INV = low		0.6	ns
		2 pixel and STAG, PIXS = high, STAG = low, OCK_INV = low		2.5	
		2 pixel/clock, PIXS = high, STAG = high, OCK_INV = low		2.9	

(1) Specified as ac parameter to include sensitivity to overshoot, undershoot and reflection.

(2) By characterization

(3) t<sub>bit</sub> is 1/10 the pixel time, t<sub>pix</sub>

(4) t<sub>pix</sub> is the pixel time defined as the period of the RxC input clock. The period of ODCK is equal to t<sub>pix</sub> in 1-pixel/clock mode or 2t<sub>pix</sub> when in 2-pixel/clock mode.

(5) Measured differentially at 50% crossing using ODCK output clock as trigger

(6) Rise and fall times measured as time between 20% and 80% of signal amplitude.

(7) Data and control signals are QE[23:0], QO[23:0], DE, HSYNC, VSYNC. and CTL[3:1].

**AC ELECTRICAL CHARACTERISTICS (continued)**

over recommended operating free-air temperature range (unless otherwise noted)

PARAMETER		TEST CONDITIONS	MIN	TYP	MAX	UNIT
$t_{su2}$	Setup time, data and control signal to rising edge of ODCK	1 pixel/clock, PIXS = low, OCK_INV = high	2.1			ns
		2 pixel/clock, PIXS = high, STAG = high, OCK_INV = high	4			
		2 pixel and STAG, PIXS = high, STAG = low, OCK_INV = high	1.5			
$t_{h2}$	Hold time, data and control signal to rising edge of ODCK	1 pixel/clock, PIXS = low, OCK_INV = high	0.5			ns
		2 pixel and STAG, PIXS = high, STAG = low, OCK_INV = high	2.4			
		2 pixel/clock, PIXS = high, STAG = high, OCK_INV = high	2.1			
$f_{ODCK}$	ODCK frequency	PIX = low (1-PIX/CLK)	25		165	MHz
		PIX = high (2-PIX/CLK)	12.5		82.5	
	ODCK duty-cycle		40%	50%	60%	
$t_{pd(PDL)}$	Propagation delay time from $\overline{PD}$ low to Hi-Z outputs				9	ns
$t_{pd(PDOL)}$	Propagation delay time from $\overline{PDO}$ low to Hi-Z outputs				9	ns
$t_{t(HSC)}$	Transition time between DE transition to SCDT low <sup>(8)</sup>			1e6		$t_{pix}$
$t_{t(FSC)}$	Transition time between DE transition to SCDT high <sup>(8)</sup>			1600		$t_{pix}$
$t_{d(st)}$	Delay time, ODCK latching edge to QE[23:0] data output	$\overline{STAG}$ = low, PIXS = high		0.25		$t_{pix}$

(8) Link active or inactive is determined by amount of time detected between DE transitions. SCDT indicates link activity.



### 2.3.2 Parameter Measurement Information

#### PARAMETER MEASUREMENT INFORMATION

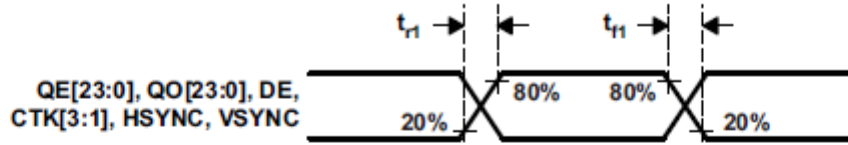


Figure 1. Rise and Fall Times of Data and Control Signals

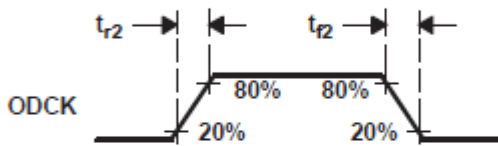


Figure 2. Rise and Fall Times of ODCK

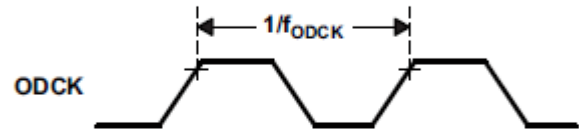


Figure 3. ODCK Frequency

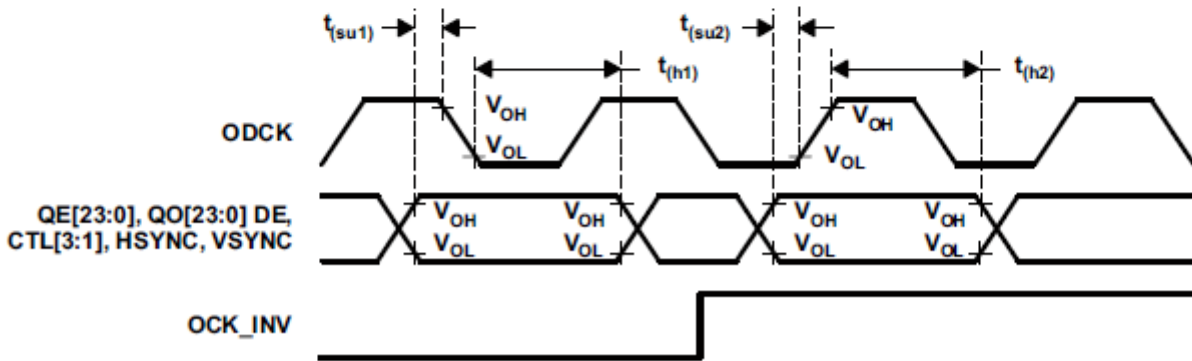


Figure 4. Data Setup and Hold Times to Rising and Falling Edges of ODCK

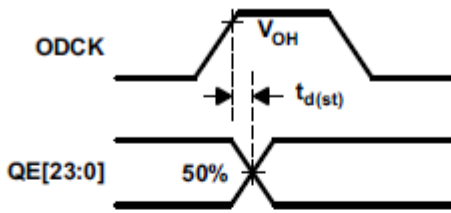


Figure 5. ODCK High to QE[23:0] Staggered Data Output

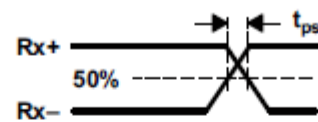


Figure 6. Analog Input Intra-Pair Differential Skew

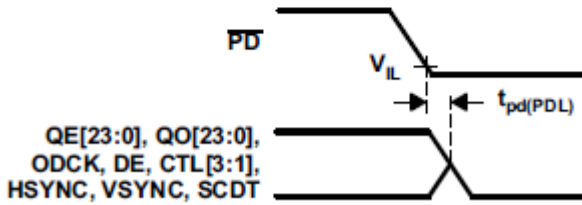


Figure 7. Delay From  $\overline{PD}$  Low to Hi-Z Outputs

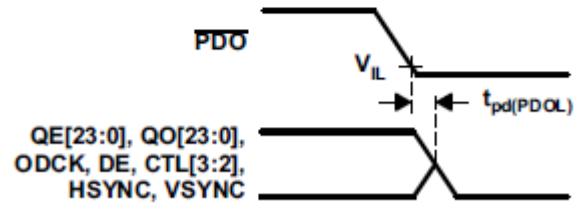


Figure 8. Delay From  $\overline{PDO}$  Low to Hi-Z Outputs

## PARAMETER MEASUREMENT INFORMATION (continued)

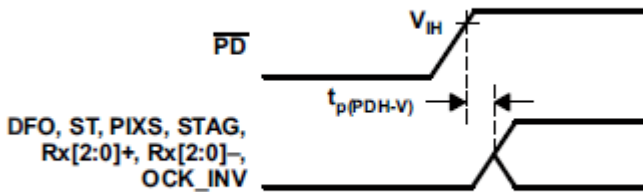


Figure 9. Delay From  $\overline{PD}$  Low to High Before Inputs Are Active

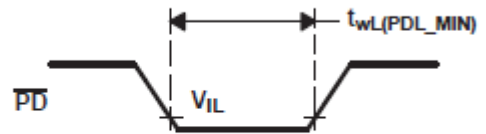
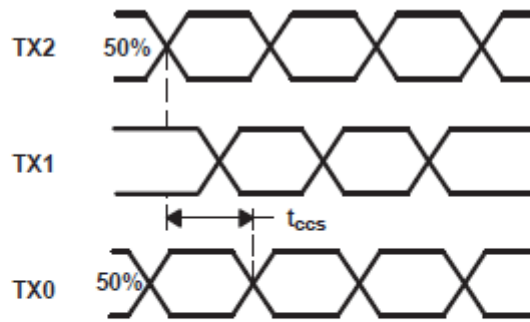
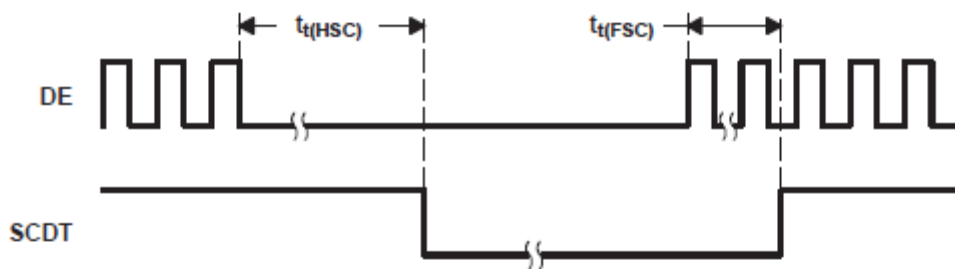


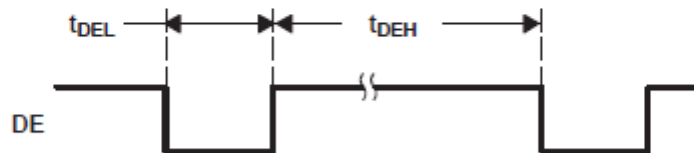
Figure 10. Minimum Time  $\overline{PD}$  Low



**Figure 11. Analog Input Channel-to-Channel Skew**

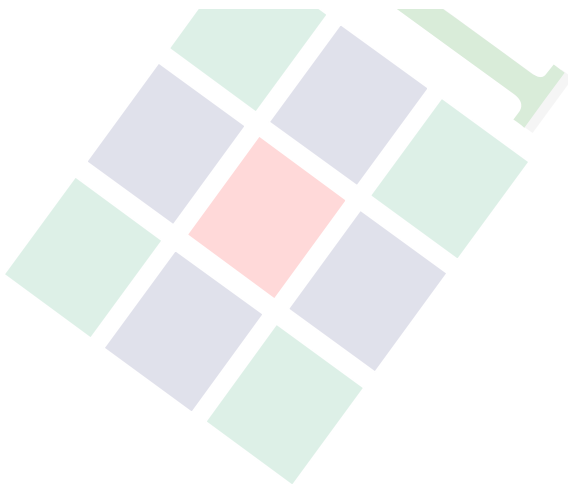


**Figure 12. Time Between DE Transitions to SCDT Low and SCDT High**



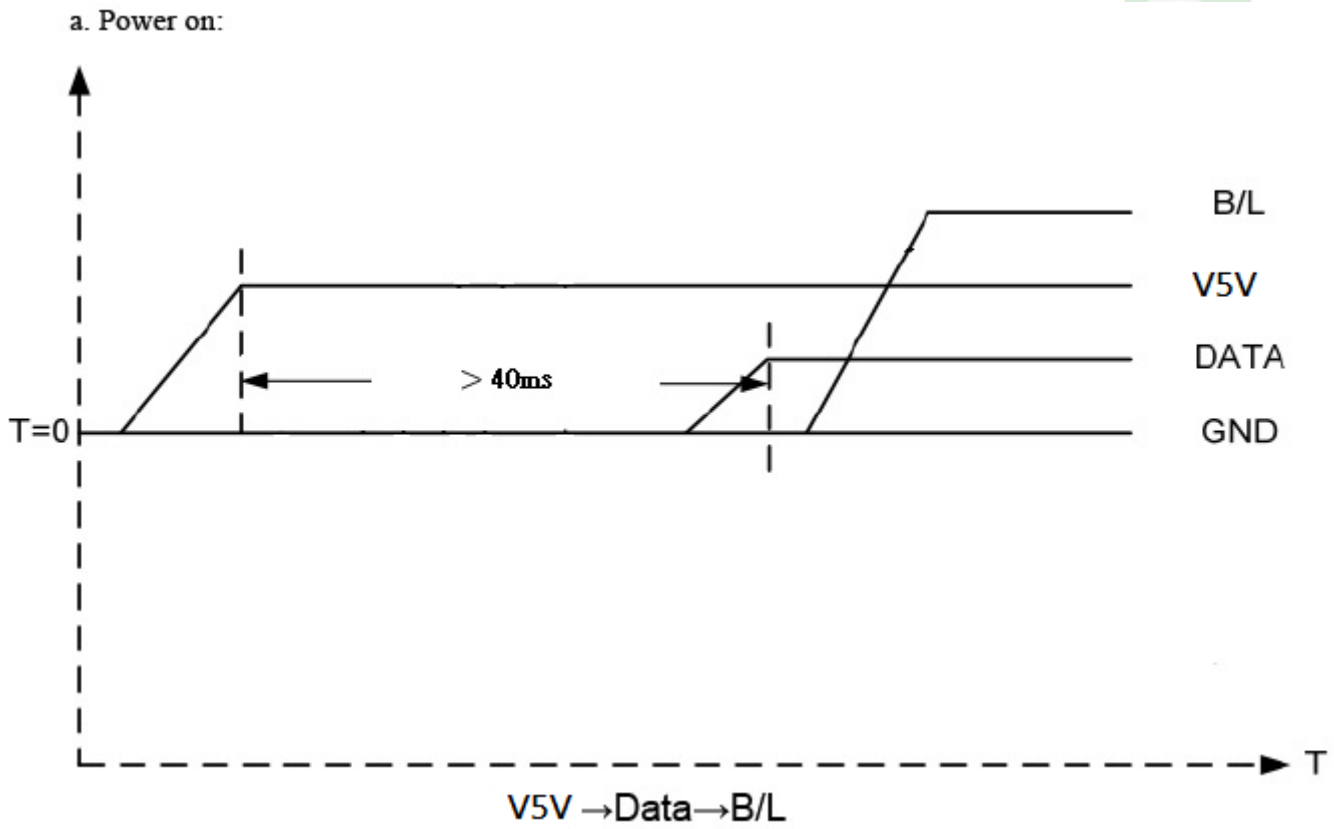
**Figure 13. Minimum DE Low and Maximum DE High**

### DETAILED DESCRIPTION



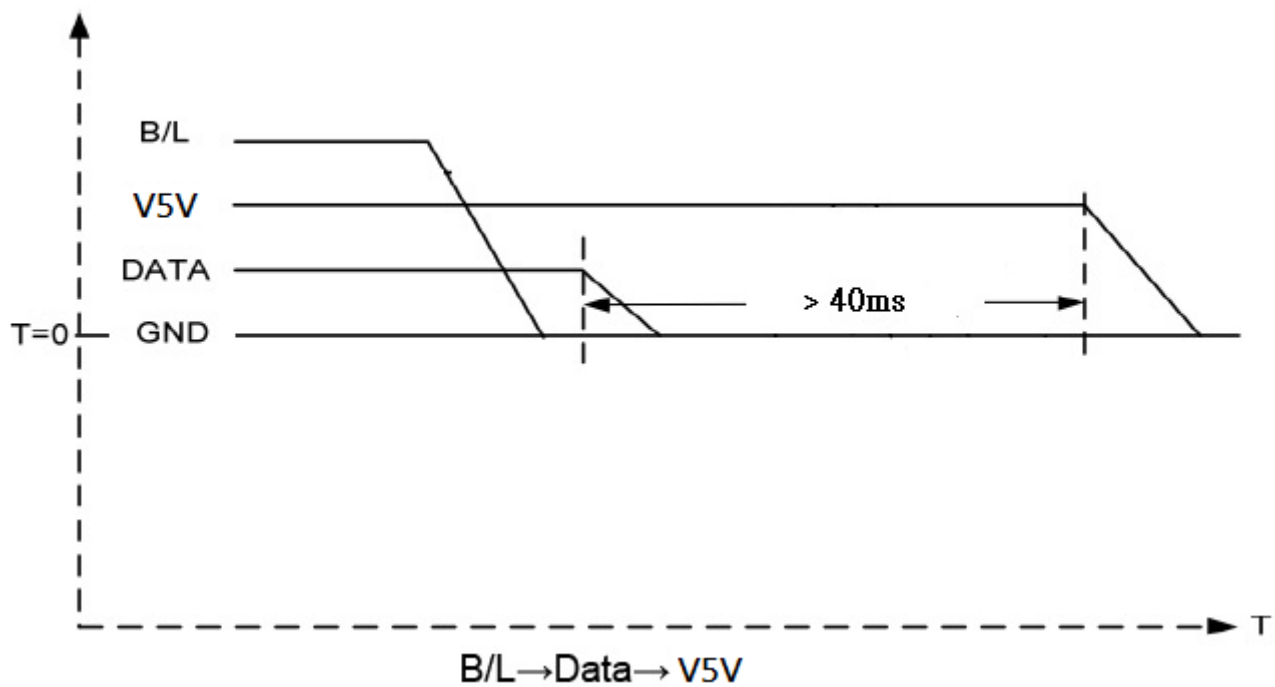
## 2.3.3 Power Sequence

### POWER ON



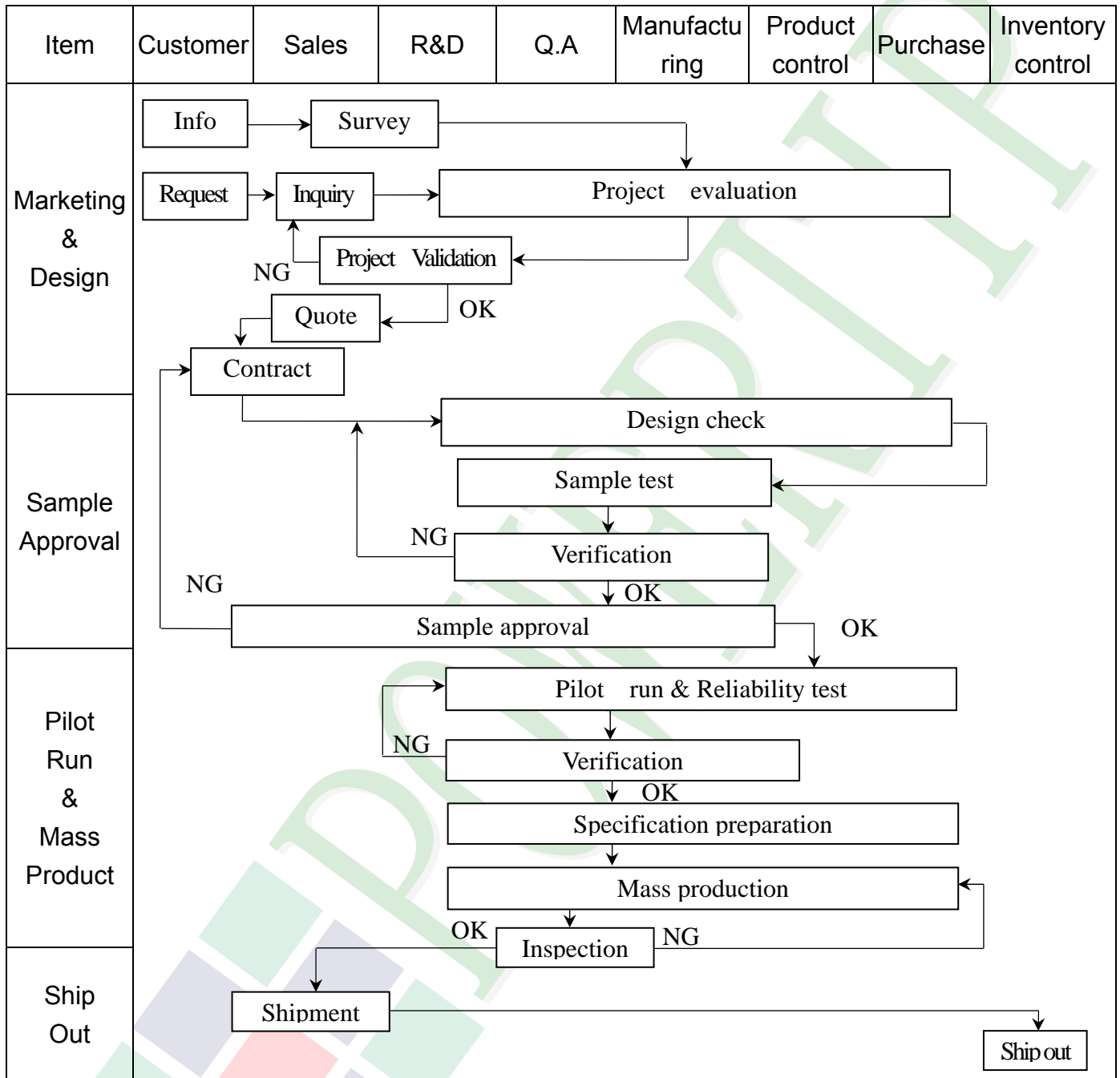
### POWER OFF

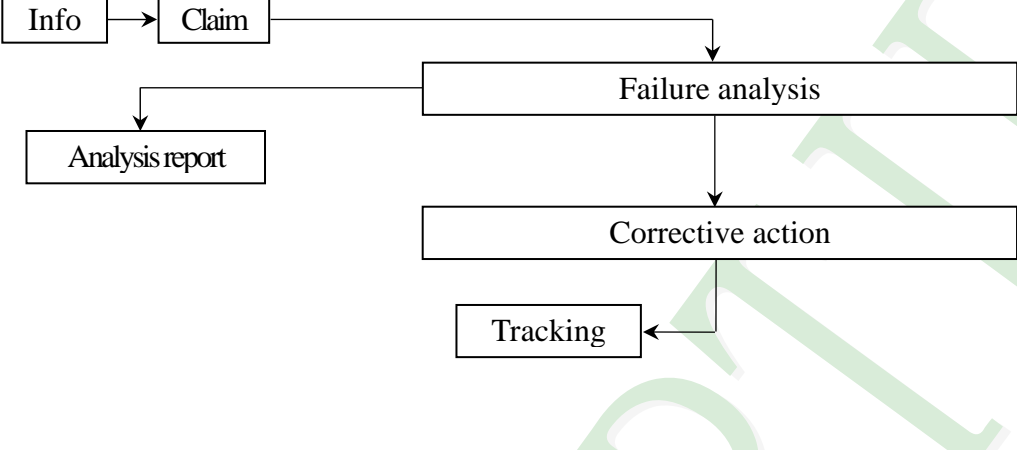
#### b. Power off:



### 3. QUALITY ASSURANCE SYSTEM

#### 3.1 Quality Assurance Flow Chart



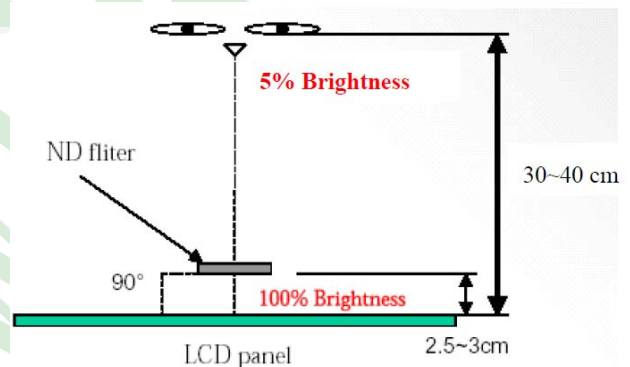
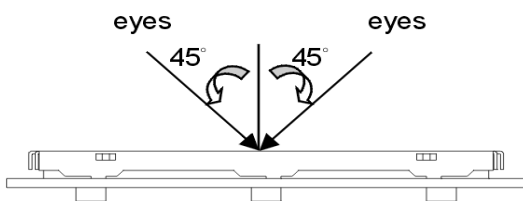
Item	Customer	Sales	R&D	Q.A	Manufacturing	Product control	Purchase	Inventory control
Sales Service	 <pre> graph TD     Info[Info] --&gt; Claim[Claim]     Claim --&gt; FA[Failure analysis]     Claim --&gt; AR[Analysis report]     FA --&gt; CA[Corrective action]     CA --&gt; Tracking[Tracking]           </pre>							
Q.A Activity	1. ISO 9001 Maintenance Activities 3. Equipment calibration 5. Standardization Management				2. Process improvement proposal 4. Education And Training Activities			

### 3.2. Inspection Specification

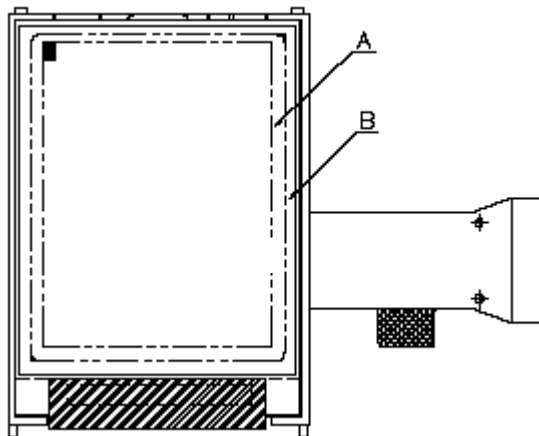
- ◆Scope: The document shall be applied to TFT-LCD Module for 3.5" -15" (Ver.B01).
- ◆Inspection Standard: MIL-STD-105E Table Normal Inspection Single Sampling Level II.
- ◆Equipment: Gauge, MIL-STD, Powertip Tester, Sample
- ◆Defect Level: Major Defect AQL: 0. 4; Minor Defect AQL: 1. 5
- ◆OUT Going Defect Level: Sampling.
- ◆Standard of the product appearance test:

#### a. Manner of appearance test:

- (1). The test best be under 20W×2 fluorescent light(about 300lux ~500lux)  
, and distance of view must be at 30~40 cm.
- (2). The test direction is base on about around 45° of vertical line.



#### (3). Definition of area.



A area: viewing area

B area: Outside of viewing area

#### (4). Standard of inspection : (Unit : mm)

**◆ Specification For TFT-LCD Module 3.5" ~15" :**

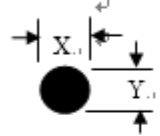
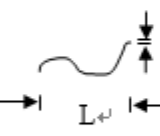
(Ver.B01)

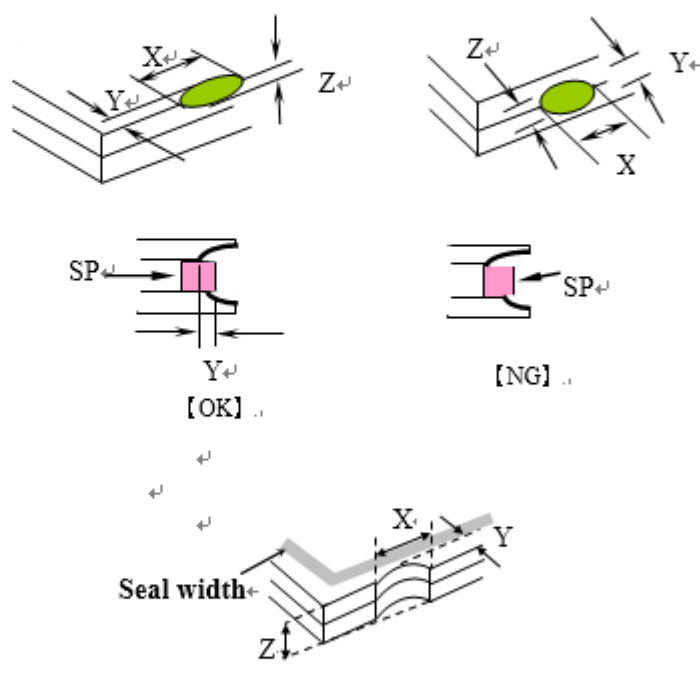
NO	Item	Criterion	Level										
01	Product condition	1. 1The part number is inconsistent with work order of production.	Major										
		1. 2 Mixed product types.	Major										
		1. 3 Assembled in inverse direction.	Major										
02	Quantity	2. 1The quantity is inconsistent with work order of production.	Major										
03	Outline dimension	3. 1Product dimension and structure must conform to structure diagram.	Major										
04	Electrical Testing	4. 1 Missing line character and icon.	Major										
		4. 2 No function or no display.	Major										
		4. 3 Display malfunction.	Major										
		4. 4 LCD viewing angle defect.	Major										
		4. 5 Current consumption exceeds product specifications.	Major										
		4. 6Mura cannot be seen through 5% ND filter at 50% Gray , should be judged by the viewing angle of 90 degree.	Minor										
05	Dot defect (Bright dot, Dark dot) On -display	<table border="1"> <thead> <tr> <th>Item</th> <th>Acceptance (Q'ty)</th> </tr> </thead> <tbody> <tr> <td>Bright Dot</td> <td>≦ 4</td> </tr> <tr> <td>Dark Dot</td> <td>≦ 5</td> </tr> <tr> <td>Joint Dot</td> <td>≦ 3</td> </tr> <tr> <td>Total</td> <td>≦ 7</td> </tr> </tbody> </table>	Item	Acceptance (Q'ty)	Bright Dot	≦ 4	Dark Dot	≦ 5	Joint Dot	≦ 3	Total	≦ 7	Minor
		Item	Acceptance (Q'ty)										
		Bright Dot	≦ 4										
		Dark Dot	≦ 5										
		Joint Dot	≦ 3										
Total	≦ 7												
5. 1 Inspection pattern: full white, full black, Red, Green and blue screens.													
5. 2 It is defined as dot defect if defect area >1/2 dot.													
5. 3 The distance between two dot defect ≧5 mm.													
5. 4 Bright dot that can not be seen through 5% ND filter.													

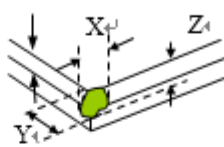
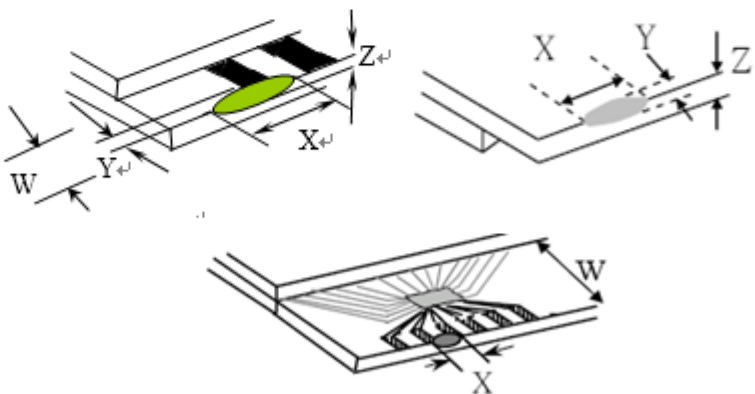


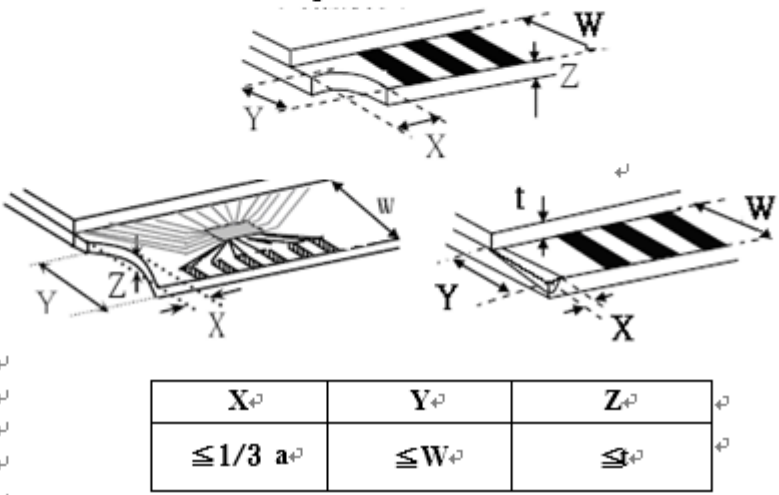
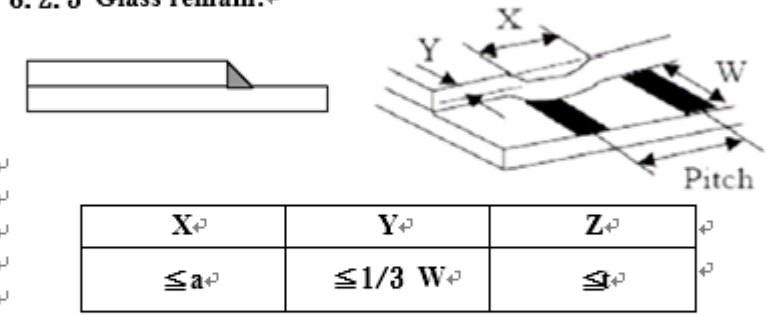

**◆ Specification For TFT-LCD Module 3.5" ~15" :**

(Ver.B01)

NO	Item	Criterion	Level																																																					
06	Black or white Dot, scratch, contamination Round type  $\Phi = (x + y) / 2$ Line type 	<b>6.1 Round type (Non-display or display):</b> <table border="1"> <thead> <tr> <th rowspan="2">Dimension (diameter : <math>\Phi</math>)</th> <th colspan="2">Acceptance (Q'ty)</th> </tr> <tr> <th>A area</th> <th>B area</th> </tr> </thead> <tbody> <tr> <td><math>\Phi \leq 0.25</math></td> <td colspan="2">Ignore</td> </tr> <tr> <td><math>0.25 &lt; \Phi \leq 0.50</math></td> <td>5</td> <td rowspan="3">Ignore</td> </tr> <tr> <td><math>\Phi &gt; 0.50</math></td> <td>0</td> </tr> <tr> <td><b>Total</b></td> <td>5</td> </tr> </tbody> </table> <b>6.2 Line type(Non-display or display):</b> <table border="1"> <thead> <tr> <th rowspan="2">module size</th> <th rowspan="2">Length (L)</th> <th rowspan="2">Width (W)</th> <th colspan="2">Acceptance (Q'ty)</th> </tr> <tr> <th>A area</th> <th>B area</th> </tr> </thead> <tbody> <tr> <td rowspan="5">3.5" to less 9"</td> <td>---</td> <td><math>W \leq 0.03</math></td> <td>Ignore</td> <td rowspan="5">Ignore</td> </tr> <tr> <td><math>L \leq 10.0</math></td> <td><math>0.03 &lt; W \leq 0.05</math></td> <td>4</td> </tr> <tr> <td><math>L \leq 5.0</math></td> <td><math>0.05 &lt; W \leq 0.10</math></td> <td>2</td> </tr> <tr> <td>---</td> <td><math>W &gt; 0.10</math></td> <td>As round type</td> </tr> <tr> <td colspan="2">Total</td> <td>5</td> </tr> <tr> <td rowspan="4">9" to 15"</td> <td>---</td> <td><math>W \leq 0.05</math></td> <td>Ignore</td> <td rowspan="4">Ignore</td> </tr> <tr> <td><math>L \leq 10.0</math></td> <td><math>0.05 &lt; W \leq 0.10</math></td> <td>5</td> </tr> <tr> <td>---</td> <td><math>W &gt; 0.10</math></td> <td>As round type</td> </tr> <tr> <td colspan="2">Total</td> <td>5</td> </tr> </tbody> </table>	Dimension (diameter : $\Phi$ )	Acceptance (Q'ty)		A area	B area	$\Phi \leq 0.25$	Ignore		$0.25 < \Phi \leq 0.50$	5	Ignore	$\Phi > 0.50$	0	<b>Total</b>	5	module size	Length (L)	Width (W)	Acceptance (Q'ty)		A area	B area	3.5" to less 9"	---	$W \leq 0.03$	Ignore	Ignore	$L \leq 10.0$	$0.03 < W \leq 0.05$	4	$L \leq 5.0$	$0.05 < W \leq 0.10$	2	---	$W > 0.10$	As round type	Total		5	9" to 15"	---	$W \leq 0.05$	Ignore	Ignore	$L \leq 10.0$	$0.05 < W \leq 0.10$	5	---	$W > 0.10$	As round type	Total		5	Minor
Dimension (diameter : $\Phi$ )	Acceptance (Q'ty)																																																							
	A area	B area																																																						
$\Phi \leq 0.25$	Ignore																																																							
$0.25 < \Phi \leq 0.50$	5	Ignore																																																						
$\Phi > 0.50$	0																																																							
<b>Total</b>	5																																																							
module size	Length (L)	Width (W)	Acceptance (Q'ty)																																																					
			A area	B area																																																				
3.5" to less 9"	---	$W \leq 0.03$	Ignore	Ignore																																																				
	$L \leq 10.0$	$0.03 < W \leq 0.05$	4																																																					
	$L \leq 5.0$	$0.05 < W \leq 0.10$	2																																																					
	---	$W > 0.10$	As round type																																																					
	Total		5																																																					
9" to 15"	---	$W \leq 0.05$	Ignore	Ignore																																																				
	$L \leq 10.0$	$0.05 < W \leq 0.10$	5																																																					
	---	$W > 0.10$	As round type																																																					
	Total		5																																																					
07	Polarizer Bubble	<table border="1"> <thead> <tr> <th rowspan="2">Dimension (diameter: <math>\Phi</math>)</th> <th colspan="2">Acceptance (Q'ty)</th> </tr> <tr> <th>A area</th> <th>B area</th> </tr> </thead> <tbody> <tr> <td><math>\Phi \leq 0.25</math></td> <td>Ignore</td> <td rowspan="5">Ignore</td> </tr> <tr> <td><math>0.25 &lt; \Phi \leq 0.50</math></td> <td>4</td> </tr> <tr> <td><math>0.50 &lt; \Phi \leq 0.80</math></td> <td>1</td> </tr> <tr> <td><math>\Phi &gt; 0.80</math></td> <td>0</td> </tr> <tr> <td><b>Total</b></td> <td>5</td> </tr> </tbody> </table>	Dimension (diameter: $\Phi$ )	Acceptance (Q'ty)		A area	B area	$\Phi \leq 0.25$	Ignore	Ignore	$0.25 < \Phi \leq 0.50$	4	$0.50 < \Phi \leq 0.80$	1	$\Phi > 0.80$	0	<b>Total</b>	5	Minor																																					
Dimension (diameter: $\Phi$ )	Acceptance (Q'ty)																																																							
	A area	B area																																																						
$\Phi \leq 0.25$	Ignore	Ignore																																																						
$0.25 < \Phi \leq 0.50$	4																																																							
$0.50 < \Phi \leq 0.80$	1																																																							
$\Phi > 0.80$	0																																																							
<b>Total</b>	5																																																							

NO	Item	Criterion	Level									
08	The crack of glass	<p>           Symbols :  <b>X:</b> The length of crack  <b>Z:</b> The thickness of crack  <b>t:</b> The thickness of glass  <b>Y:</b> The width of crack.  <b>W:</b> terminal length  <b>a:</b> LCD side length         </p> <hr/> <p> <b>8.1 General glass chip:</b>  <b>8.1.1 Chip on panel surface and crack between panels:</b> </p>  <table border="1" data-bbox="566 1422 1292 1691"> <thead> <tr> <th>X</th> <th>Y</th> <th>Z</th> </tr> </thead> <tbody> <tr> <td><math>\leq a</math></td> <td>Crack can't enter viewing area</td> <td><math>\leq 1/2 t</math></td> </tr> <tr> <td><math>\leq a</math></td> <td>Crack can't exceed the half of SP width.</td> <td><math>1/2 t &lt; Z \leq 2 t</math></td> </tr> </tbody> </table>	X	Y	Z	$\leq a$	Crack can't enter viewing area	$\leq 1/2 t$	$\leq a$	Crack can't exceed the half of SP width.	$1/2 t < Z \leq 2 t$	Minor
X	Y	Z										
$\leq a$	Crack can't enter viewing area	$\leq 1/2 t$										
$\leq a$	Crack can't exceed the half of SP width.	$1/2 t < Z \leq 2 t$										

NO	Item	Criterion	Level												
08	The crack of glass	<p><b>Symbols :</b></p> <p>X: The length of crack                      Y: The width of crack.</p> <p>Z: The thickness of crack                  W: terminal length</p> <p>t: The thickness of glass                  a: LCD side length</p> <hr/> <p><b>8.1.2 Corner crack:</b></p>  <table border="1" data-bbox="555 712 1284 974"> <thead> <tr> <th>X</th> <th>Y</th> <th>Z</th> </tr> </thead> <tbody> <tr> <td><math>\leq 1/5 a</math></td> <td>Crack can't enter viewing area</td> <td><math>Z \leq 1/2 t</math></td> </tr> <tr> <td><math>\leq 1/5 a</math></td> <td>Crack can't exceed the half of SP width.</td> <td><math>1/2 t &lt; Z \leq 2 t</math></td> </tr> </tbody> </table>	X	Y	Z	$\leq 1/5 a$	Crack can't enter viewing area	$Z \leq 1/2 t$	$\leq 1/5 a$	Crack can't exceed the half of SP width.	$1/2 t < Z \leq 2 t$				
		X	Y	Z											
$\leq 1/5 a$	Crack can't enter viewing area	$Z \leq 1/2 t$													
$\leq 1/5 a$	Crack can't exceed the half of SP width.	$1/2 t < Z \leq 2 t$													
		<p><b>8.2 Protrusion over terminal:</b></p> <p><b>8.2.1 Chip on electrode pad:</b></p>  <table border="1" data-bbox="587 1545 1292 1702"> <thead> <tr> <th></th> <th>X</th> <th>Y</th> <th>Z</th> </tr> </thead> <tbody> <tr> <td>Front</td> <td><math>\leq a</math></td> <td><math>\leq 1/2 W</math></td> <td><math>\leq t</math></td> </tr> <tr> <td>Back</td> <td><math>\leq a</math></td> <td><math>\leq W</math></td> <td><math>\leq 1/2 t</math></td> </tr> </tbody> </table>		X	Y	Z	Front	$\leq a$	$\leq 1/2 W$	$\leq t$	Back	$\leq a$	$\leq W$	$\leq 1/2 t$	Minor
	X	Y	Z												
Front	$\leq a$	$\leq 1/2 W$	$\leq t$												
Back	$\leq a$	$\leq W$	$\leq 1/2 t$												

NO	Item	Criterion	Level
08	The crack of glass	<p><b>Symbols:</b></p> <p>X: The length of crack                      Y: The width of crack.</p> <p>Z: The thickness of crack                  W: terminal length</p> <p>t: The thickness of glass                    a: LCD side length</p> <hr/> <p><b>8.2.2 Non-conductive portion:</b></p>  <p>⊙ If the chipped area touches the ITO terminal, over 2/3 of the ITO must remain and be inspected according to electrode terminal specifications.</p> <p><b>8.2.3 Glass remain:</b></p>  <p><b>8.2.4 Cracking:</b></p> 	Minor

**◆ Specification For TFT-LCD Module 3.5" ~15" :**

(Ver.B01)

NO	Item	Criterion	Level
09	Backlight elements	9. 1 Backlight can't work normally.	Major
		9. 2 Backlight doesn't light or color is wrong.	Major
		9. 3 Illumination source flickers when lit.	Major
10	General appearance	10. 1 Pin type 、 quantity 、 dimension must match type in structure diagram.	Major
		10. 2 No short circuits in components on PCB or FPC.	Major
		10. 3 Parts on PCB or FPC must be: no wrong parts, missing parts or excess parts.	Major
		10. 4 Product packaging must the same as specified on packaging specification sheet.	Minor
		10. 5 The folding and peeled off in polarizer are not acceptable.	Minor
		10. 6 The PCB or FPC between B/L assembled distance(PCB or FPC ) is $\leq 1.5$ mm.	Minor



## 5. PRECAUTION RELATING PRODUCT HANDLING

### 5.1 SAFETY

- 5.1.1 If the LCD panel breaks , be careful not to get the liquid crystal to touch your skin.
- 5.1.2 If the liquid crystal touches your skin or clothes , please wash it off immediately by using soap and water.

### 5.2 HANDLING

- 5.2.1 Avoid any strong mechanical shock which can break the glass.
- 5.2.2 Avoid static electricity which can damage the CMOS LSI—When working with the module , be sure to ground your body and any electrical equipment you may be using.
- 5.2.3 Do not remove the panel or frame from the module.
- 5.2.4 The polarizing plate of the display is very fragile. So , please handle it very carefully ,do not touch , push or rub the exposed polarizing with anything harder than an HB pencil lead (glass , tweezers , etc.)
- 5.2.5 Do not wipe the polarizing plate with a dry cloth , as it may easily scratch the surface of plate.
- 5.2.6 Do not touch the display area with bare hands , this will stain the display area.
- 5.2.7 Do not use ketonics solvent & aromatic solvent. Use with a soft cloth soaked with a cleaning naphtha solvent.
- 5.2.8 To control temperature and time of soldering is  $320\pm 10^{\circ}\text{C}$  and 3-5 sec.
- 5.2.9 To avoid liquid (include organic solvent) stained on LCM .

### 5.3 STORAGE

- 5.3.1 Store the panel or module in a dark place where the temperature is  $25^{\circ}\text{C} \pm 5^{\circ}\text{C}$  and the humidity is below 65% RH.
- 5.3.2 Do not place the module near organics solvents or corrosive gases.
- 5.3.3 Do not crush , shake , or jolt the module.

### 5.4 TERMS OF WARRANTY

- 5.4.1 Applicable warrant period  
The period is within thirteen months since the date of shipping out under normal using and storage conditions.
- 5.4.2 Unaccepted responsibility  
This product has been manufactured to your company's specification as a part for use in your company's general electronic products. It is guaranteed to perform according to delivery specifications. For any other use apart from general electronic equipment , we cannot take responsibility if the product is used in nuclear power control equipment , aerospace equipment , fire and security systems or any other applications in which there is a direct risk to human life and where extremely high levels of reliability are required.





Ver.001

Documents NO. PKG-PH480272T005-IHC03

# LCM包裝規格書

## LCM Packaging Specifications

Approve	Check	Contact
Oliver	Oliver	Stone

### 1. 包裝材料規格表 (Packaging Material) : (per carton)

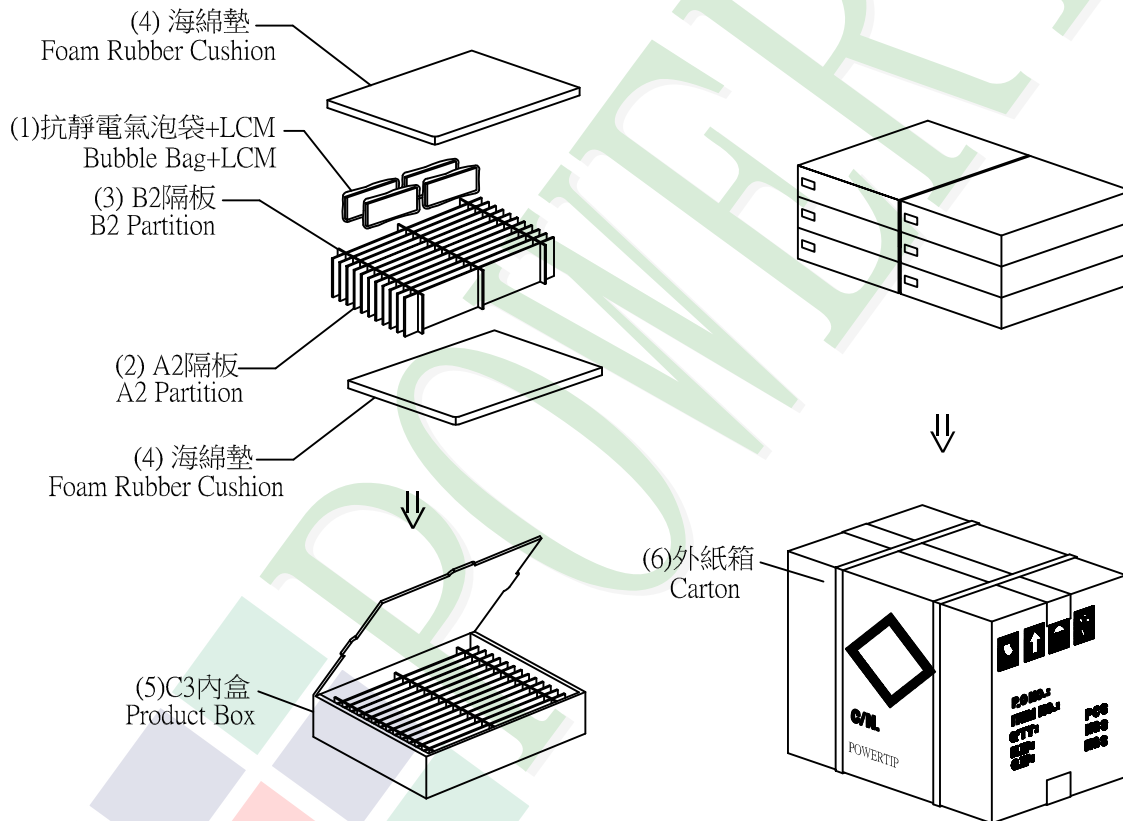
No.	Item	Model	Dimensions (mm)	1Pcs Weight	Quantity	Total Weight
1	成品 (LCM)	PH480272T005-IHC03	105.5 X 67.2	0.1034	120	12.408
2	抗靜電氣泡袋(1)Bubble Bag	BAG0000000005	150 X 120	0.002	120	0.24
3	A2隔板(2)A2 Partition	BX29300070BMBA	293 X 70 X 2.5	0.011	66	0.726
4	B2隔板(3)B2 Partition	BX24500070BLBA	245 X 70 X 2.5	0.01	18	0.18
5	海綿墊(4)Foam Rubber Cushion	OTFOAM00006ABA	290 X 240 X 10	0.02	12	0.24
6	C3內盒(5)Product Box	BX31025510AABA	310 X 255 X 100	0.263	6	1.578
7	外紙箱(6)Carton	BX52732536CCBA	527 X 325 X 360	1.092	1	1.092
8						
9						

2. 一整箱總重量 (Total LCD Weight in carton) : 16.47 Kg±10%

3. 單箱數量規格表 (Packaging Specifications and Quantity) :

(1)Quantity Of Spacer : A2隔板 X 11 , B2隔板 X 3

(2)Total LCM quantity in carton : quantity per box 20 x no of boxes 6 = 120



### 特記事項 (REMARK)

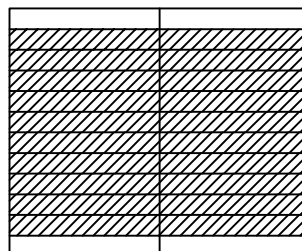
4. 每個間隔放1片模組，前後間隔不放置模組。(如放置格示意圖)

4. LCM are placed on every other slot of the divider.

Note: First and last slot should be empty.  
(See remarks 6 on packaging specifications)

5. 放置格示意圖:

5. Each divider is placed inside a product Box



▨ 模組(LCM)

□ 空格(Blank Space)