

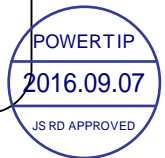

## SPECIFICATIONS

CUSTOMER	:	PTC
SAMPLE CODE	:	SH480272T009-IBC01
MASS PRODUCTION CODE	:	PH480272T009-IBC01
SAMPLE VERSION	:	02
SPECIFICATIONS EDITION	:	003
DRAWING NO. (Ver.)	:	JLMD-PH480272T009-IBC01_002
PACKAGING NO. (Ver.)	:	JPKG-PH480272T009-IBC01_001

<b>Customer Approved</b>
Date: _____



Approved	Checked	Designer
閔偉	劉進	張斌

- Preliminary specification for design input
- Specification for sample approval

### POWERTIP TECH. CORP.

**Headquarters:**

No.8, 6<sup>th</sup> Road, Taichung Industrial Park,  
Taichung, Taiwan  
台中市 407 工業區六路 8 號

TEL: 886-4-2355-8168  
FAX: 886-4-2355-8166

E-mail: [sales@powertip.com.tw](mailto:sales@powertip.com.tw)  
[Http://www.powertip.com.tw](http://www.powertip.com.tw)

### History of Version

Date (mm / dd / yyyy)	Ver.	Edi.	Description	Page	Design by
01/28/2016	01	001	New Drawing	-	張斌
07/04/2016	02	002	Modify TP	4,12, appendix	張斌
09/06/2016	02	003	Second Sample	-	張斌

Total: 31 Pages

## Contents

### 1. SPECIFICATIONS

- 1.1 Features
- 1.2 Mechanical Specifications
- 1.3 Absolute Maximum Ratings
- 1.4 DC Electrical Characteristics
- 1.5 Optical Characteristics
- 1.6 Backlight Characteristics
- 1.7 Touch Panel Characteristics

### 2. MODULE STRUCTURE

- 2.1 Counter Drawing
- 2.2 Interface Pin Description
- 2.3 Timing Characteristics
- 2.4 Data Format
- 2.5 Power On/Off Sequence

### 3. QUALITY ASSURANCE SYSTEM

- 3.1 Quality Assurance Flow Chart
- 3.2 Inspection Specification

### 4. RELIABILITY TEST

- 4.1 Reliability Test Condition

### 5. PRECAUTION RELATING PRODUCT HANDLING

- 5.1 Safety
- 5.2 Handling
- 5.3 Storage
- 5.4 Terms of Warranty

Appendix : LCM Drawing  
Packaging

## 1. SPECIFICATIONS

### 1.1 Features

Item	Standard Value
Display Type	480 * 3 (RGB) * 272 Dots
LCD Type	a-Si TFT , Normally white, Transmissive type
Screen size(inch)	4.3 inch
Viewing Direction	6 O'clock
Color configuration	RGB-Strip
Interface	Digital 24-bits RGB
Other(controller/driver IC)	ILI6480B (Or Compatible IC )
ROHS	THIS PRODUCT CONFORMS THE ROHS OF PTC Detail information please refer website : <a href="http://www.powertip.com.tw/news.php?area_id_view=1085560481/">http://www.powertip.com.tw/news.php?area_id_view=1085560481/</a>

### 1.2 Mechanical Specifications

Item	Standard Value	Unit
Outline Dimension	115.1(W) * 78.94 (L) * 5.5(H)	mm

#### TFT LCD Panel

Item	Standard Value	Unit
Active Area(LCD)	95.04 (W) x 53.856 (L)	mm

Note : For detailed information please refer to LCM drawing

### 1.3 Absolute Maximum Ratings

#### Module

Item	Symbol	Condition	Min.	Max.	Unit
System Power Supply Voltage	VDDIO	GND=0	-0.5	5.0	V
Operating Temperature	T <sub>OP</sub>	-	-20	70	°C
Storage Temperature	T <sub>ST</sub>	-	-30	80	°C
Storage Humidity	HD	T <sub>a</sub> ≤ 60 °C	20	90	%RH

### 1.4 DC Electrical Characteristics

#### Module

GND = 0V, T<sub>a</sub> = 25°C

Item	Symbol	Condition	Min.	Typ.	Max.	Unit
Power Supply Voltage	VDD	-	3.0	3.3	3.6	V
Digital interface supply Voltage	VDDIO	-	1.8	-	VDD	V
Input H/L Level Voltage	V <sub>IH</sub>	-	0.7VDDIO	-	VDDIO	V
	V <sub>IL</sub>	-	0	-	0.3VDDIO	V
Output H/L Level Voltage	V <sub>OH</sub>	-	VDDIO-0.4	-	-	V
	V <sub>OL</sub>	-	0	-	0.4	V
Supply Current	I <sub>DD</sub>	VDD = VDDIO = 3.3 V	-	16	24	mA

## 1.5 Optical Characteristics

### TFT LCD Module

VDD = VDDIO = 3.3 V, Ta=25°C

Item		Symbol	Condition	Min.	Typ.	Max.	unit	-
Response time	Tr+Tf	25°C	-	-	30	45	ms	Note 2
Viewing angle	Top	Θ+	CR ≥ 10	-	60	-	Deg.	Note 1
	Bottom	Θ-		-	60	-		
	Left	ΘL		-	60	-		
	Right	ΘR		-	60	-		
Contrast ratio		CR	-	500	600	-	-	Note 3
Color of CIE Coordinate ( With B/L&T/P )	White	X	IF= 20 mA	0.25	0.30	0.35	-	Note4
		Y		0.28	0.33	0.38		
	Red	X		0.51	0.56	0.61		
		Y		0.27	0.32	0.37		
	Green	X		0.29	0.34	0.39		
		Y		0.57	0.62	0.67		
	Blue	X		0.10	0.15	0.20		
		Y		0.02	0.07	0.12		
Average Brightness Pattern=white display (With B/L&T/P)*1		IV	IF= 20 mA	420	460	-	cd/m <sup>2</sup>	
Uniformity (With B/L&T/P)*2		△B	IF= 20 mA	80	-	-	%	

Note 4 :

1 :  $\Delta B = B(\min) / B(\max) * 100\%$

2 : Measurement Condition for Optical Characteristics:

- a : Environment: 25°C±5°C / 60±20%R.H , no wind , dark room below 10 Lux at typical lamp current and typical operating frequency.
- b : Measurement Distance: 500 ± 50 mm , (θ= 0°)
- c : Equipment: TOPCON BM-7 fast , (field 1°) , after 10 minutes operation.
- d : The uncertainty of the C.I.E coordinate measurement ±0.01 , Average Brightness ± 4%

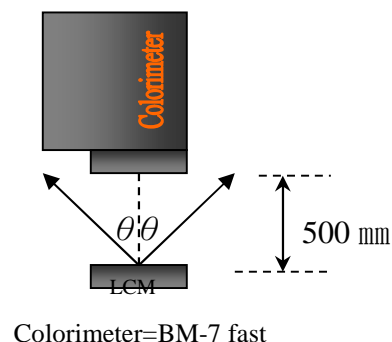
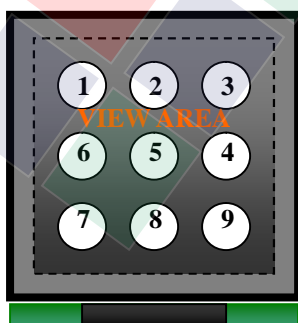

Note 1.

Optical characteristics-2

Viewing angle

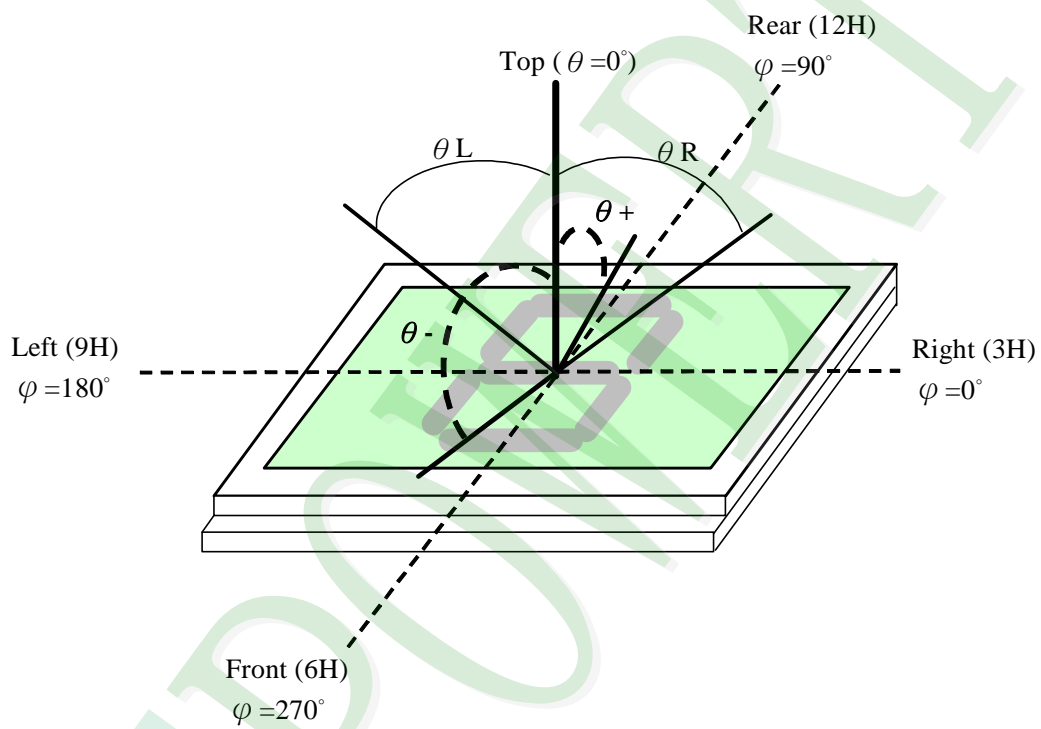

**Viewing angle**

Note 2.

Optical characteristics-3

Fig.2 Definition of response time

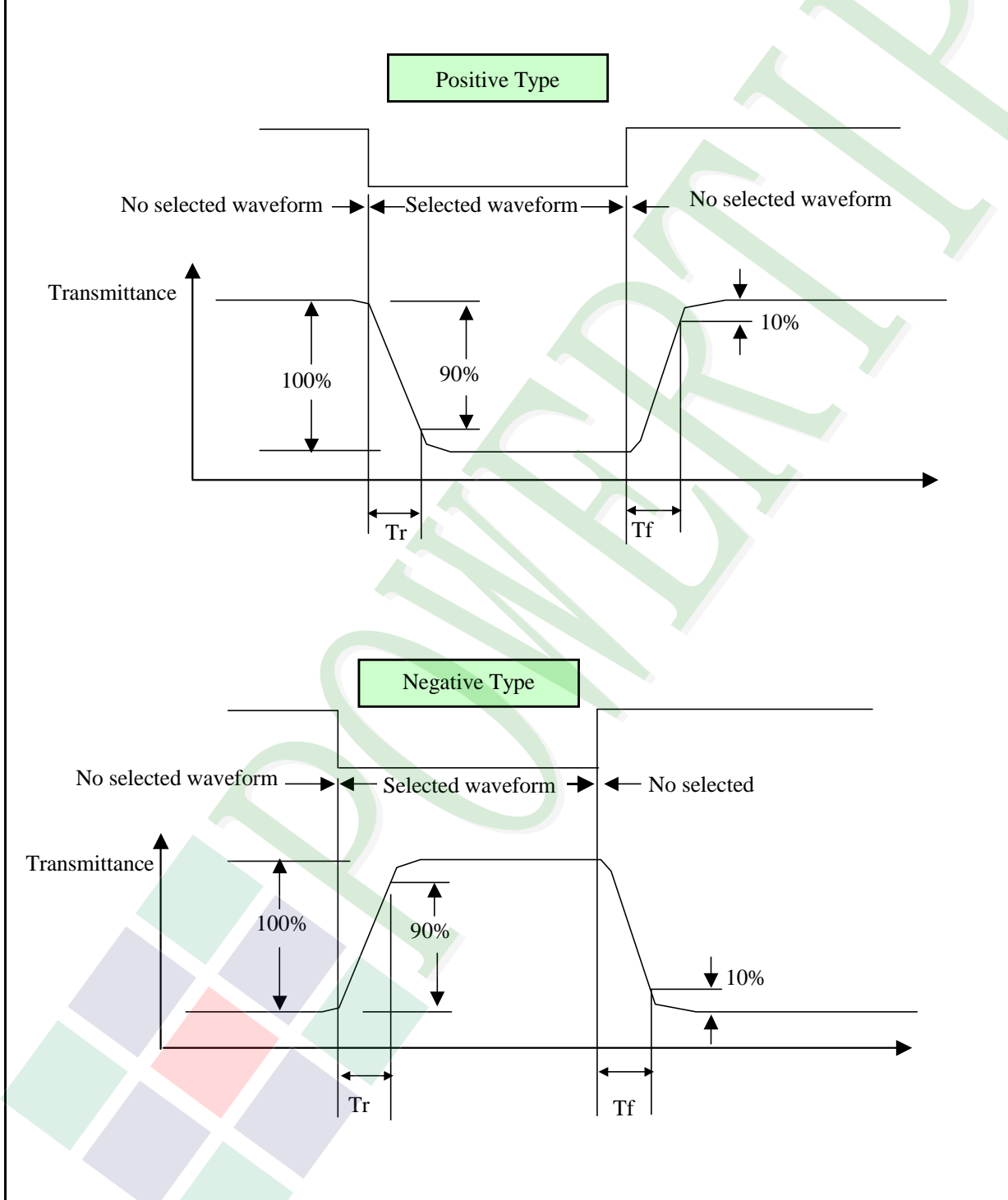





## Electrical characteristics-2

※2 Drive waveform

Vop: Drive voltage

1/B: Bias

N: Duty

fF: Frame frequency

fD: Drive frequency

### (1) Selected waveform

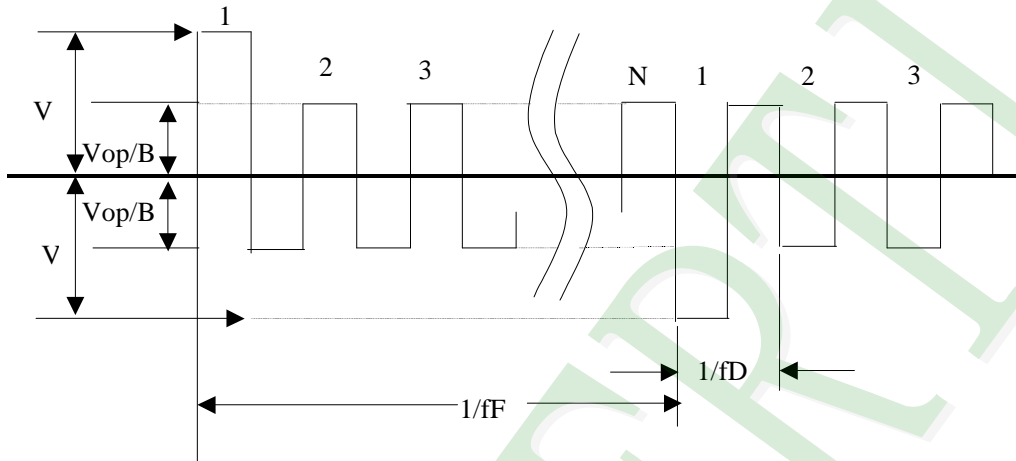

### (2) Non- Selected wave form

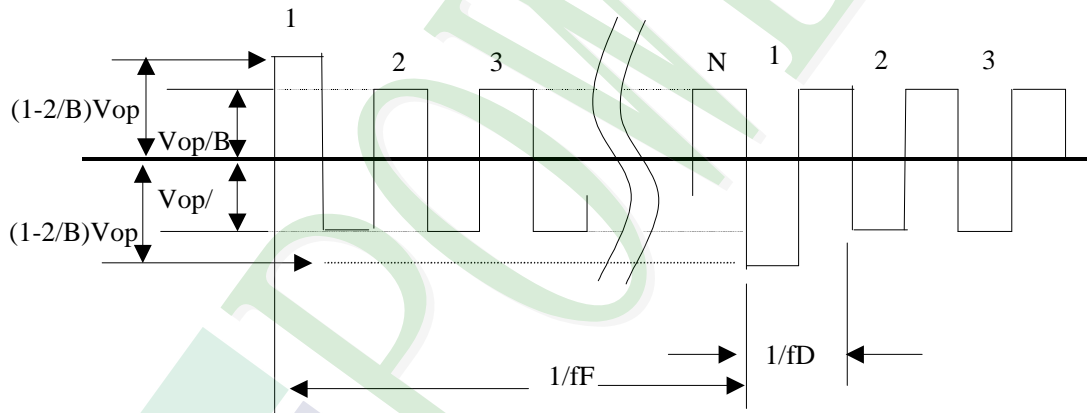

Note:

Frame frequency is defined as follows: Common side supply voltage peak - to - peak / 2 = 1 period

Note 3. : Definition of Vth

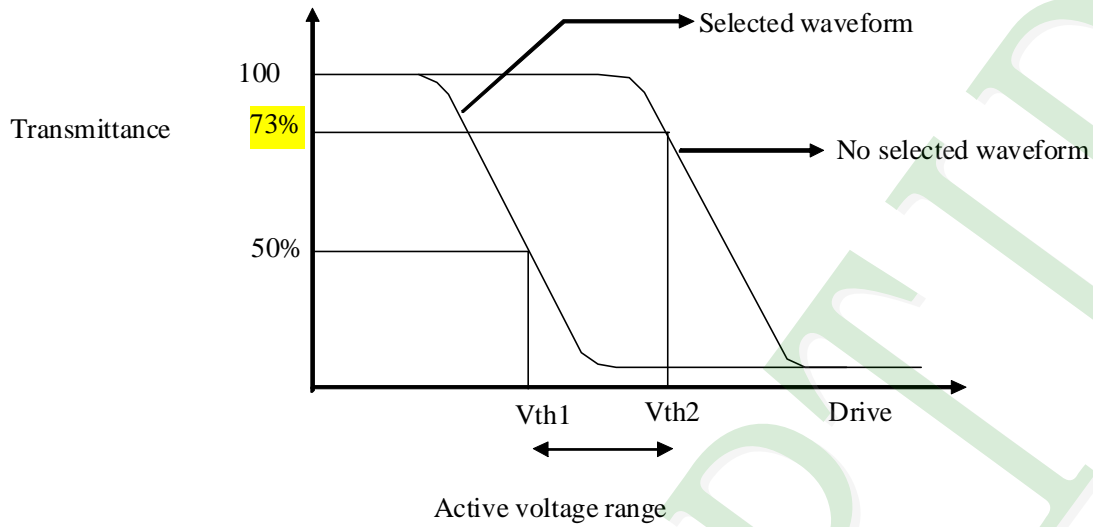

	Vth1	Vth2
View direction	10°	40°
Drive waveform	(Selected waveform)	(No selected waveform)
Transmittance	50%	73%

※1 Contrast ratio  
 = (Brightness in OFF state) / (Brightness in ON state)

Outline of Electro-Optical Characteristics Measuring System

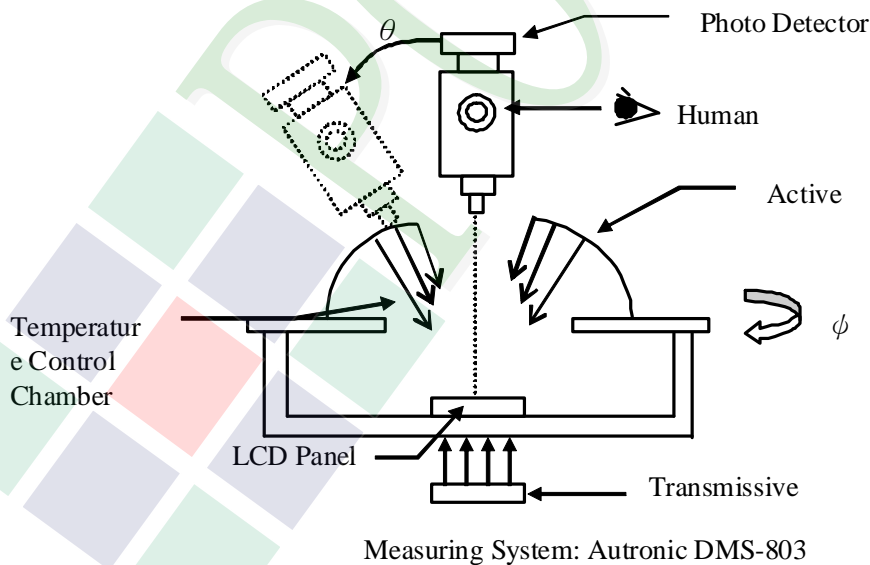

## 1.6 Backlight Characteristics

### Maximum Ratings

Item	Symbol	Conditions	Min.	Max.	Unit
LED Forward Current	IF	Ta =25°C	-	30	mA
LED Reverse Voltage	VR	Ta =25°C	-	1.0	V
Power Dissipation	PD	Ta =25°C	-	360	mW

### Electrical / Optical Characteristics

Item	Symbol	Conditions	Min.	Typ.	Max.	Unit
Forward Voltage	VF	IF= 20 mA	18.2	22.8	24.5	V
Average Brightness (Without LCD)	IV		6000	7200	-	cd/m <sup>2</sup>
CIE Color Coordinate (Without LCD)	X		0.260	0.300	0.340	-
	Y		0.300	0.340	0.380	
Color		White				

Circuit diagram:

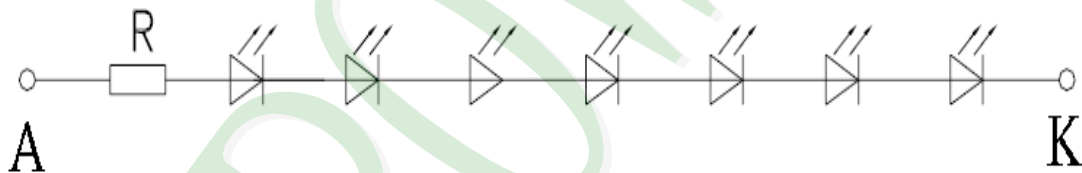

Other Description

Item	Conditions	Description
Life Time	Ta =25°C IF= 20mA	20000 hrs

## 1.7 Touch Panel Characteristics

### Features

Item	Standard Value
Touch Panel Size	4.3"
Touch type	Projective capacitive touch panel True Multi-touch with up to 5 Points of Absolution
Output Interface	I <sup>2</sup> C
IC	FT5426

### Mechanical Specifications

Item	Standard Value	Unit
Viewing Area	97.10 mm (W) x 55.90 mm (H)	mm

### Absolute Maximum Ratings

Item	Symbol	Condition	Min.	Max.	Unit
Supply voltage	VDD	-	-0.3	3.6	V
Operating Temperature	T <sub>OP</sub>	-	-20	+70	°C
Storage Temperature	T <sub>ST</sub>	-	-30	+80	°C

### DC Electrical Characteristics

Item	Symbol	Condition	Min.	Typ.	Max.	Unit
Power Supply Voltage	VDD	-	3.0	3.3	3.6	V

## 2. MODULE STRUCTURE

### 2.1 Counter Drawing

#### 2.1.1 LCM Mechanical Diagram

\* See Appendix

#### 2.1.2 Block Diagram

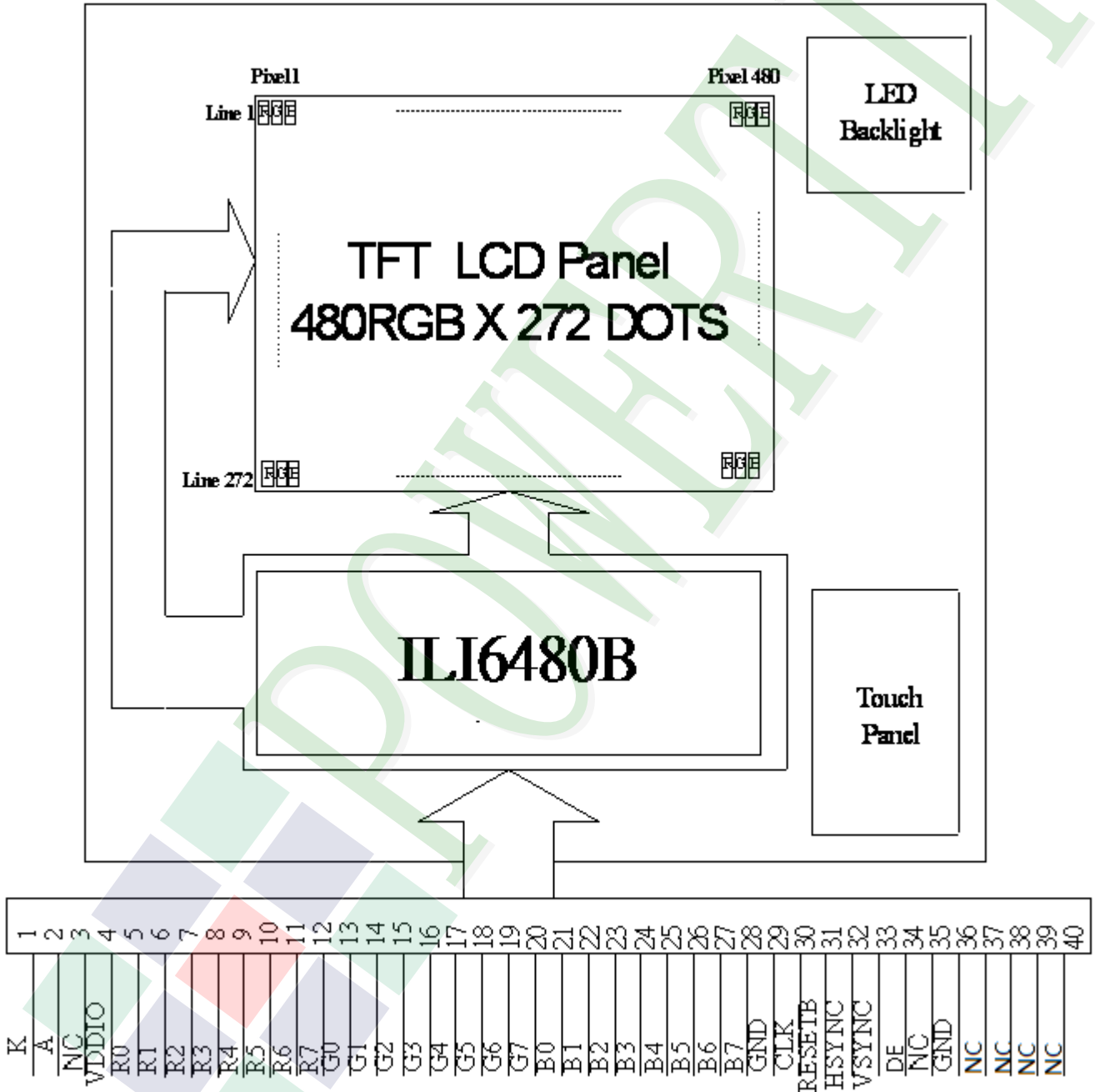

## 2.2 Interface Pin Description

Pin No.	Symbol	Function
1	K	Power supply for LED Backlight cathode input
2	A	Power supply for LED Backlight anode input
3	NC	No connection
4	VDDIO	Digital power
5	R0	Red data bit 0
6	R1	Red data bit 1
7	R2	Red data bit 2
8	R3	Red data bit 3
9	R4	Red data bit 4
10	R5	Red data bit 5
11	R6	Red data bit 6
12	R7	Red data bit 7
13	G0	Green data bit 0
14	G1	Green data bit 1
15	G2	Green data bit 2
16	G3	Green data bit 3
17	G4	Green data bit 4
18	G5	Green data bit 5
19	G6	Green data bit 6
20	G7	Green data bit 7



Pin No.	Symbol	Function
21	B0	Blue data bit 0
22	B1	Blue data bit 1
23	B2	Blue data bit 2
24	B3	Blue data bit 3
25	B4	Blue data bit 4
26	B5	Blue data bit 5
27	B6	Blue data bit 6
28	B7	Blue data bit 7
29	GND	Ground
30	CLK	Dot data clock
31	RESETB	Active low global reset signal input.
32	HSYNC	Horizontal sync input
33	VSYNC	Vertical sync input
34	NC	No connection
35	NC	No connection
36	GND	Ground
37	NC	Not Connect
38	NC	Not Connect
39	NC	Not Connect
40	NC	Not Connect

## 2.3 Timing Characteristics

### 2.3.1 Clock and Data Input Waveforms

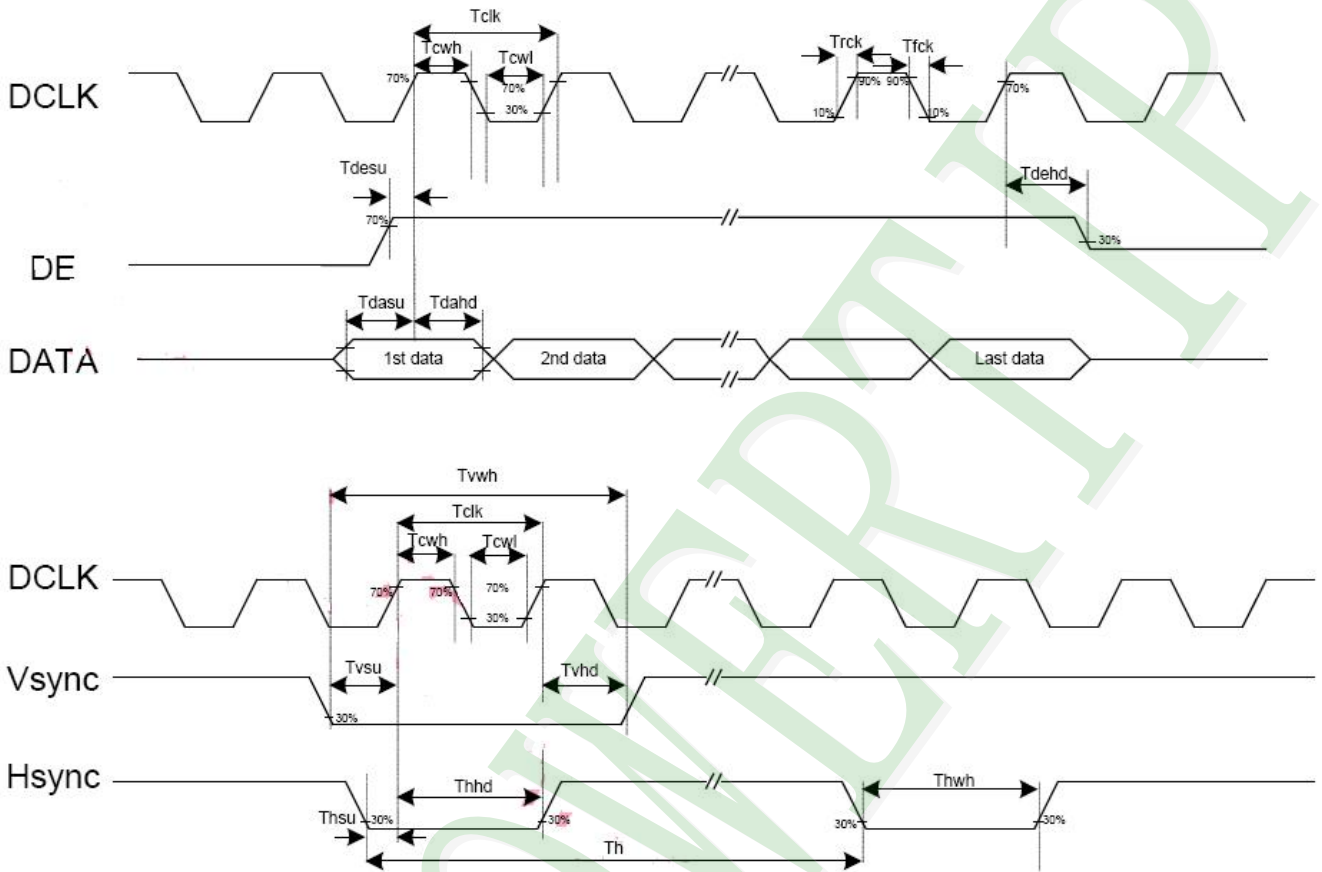



**AC Electrical Characteristics (VDDIO=VDD=3.0 to 3.6v, GND=0V, TA=-20 to +85 °C)**

Parameters	Symbol	Min.	Typ.	Max.	Unit	Conditions
<b>System operation timing</b>						
VDD power source slew time	TPOR	-	-	20	ms	From 0V to 99% VDD
GRB pulse width	tRSTW	10	50	-	us	R=10Kohm, C=1uF
<b>Input Output timing</b>						
DCLK clock time	Tclk	33.3	-	-	ns	DCLK=30MHz
DCLK clock low period	Tcwl	40	-	60	%	
DCLK clock high period	Tcwh	40	-	60	%	
Clock rising time	Trck	9	-	-	ns	
Clock falling time	Tfck	9	-	-	ns	
HSD width	Thwh	1	-	-	DCLK	
HSD period time	Th	55	60	65	us	
HSD setup time	Thsu	12	-	-	ns	
HSD hold time	Thhd	12	-	-	ns	
VSD width	Tvwh	1	-	-	Th	
VSD setup time	Tvsu	12	-	-	ns	
VSD hold time	Tvhd	12	-	-	ns	
Data setup time	Tdasu	12	-	-	ns	
Data hold time	Tdahd	12	-	-	ns	
DE setup time	Tdesu	12	-	-	ns	
DE hold time	Tdehd	12	-	-	ns	
Source output setting time	Tsst	-	-	TBD	us	10% to 90% CL=60pF, RL=2Kohm
Gate output setting time	Tgst	-	-	TBD	ns	10% to 90%, CL=60pF
VCOM output setting time	Tcst	-	-	TBD	us	10% to 90%, CL=40nF, RL=50ohm
Time from VSD to 1st line data input	Tvs	3	8	31	Th	HV mode By HDL[4:0] setting
<b>3-wire serial communication AC timing</b>						
Serial clock	Tsck	200	-	-	ns	For SCL pin
SCL pulse low period	Tckl	40	-	60	%	
SCL pulse high period	Tckh	40	-	60	%	
Serial data setup time	Tisu	50	-	-	ns	
Serial data hold time	Tihd	50	-	-	ns	
Serial clock high/low	Tssw	50	-	-	ns	
CSB to VSD	Tcv	1	-	-	us	
CSB distinguish time	Tcd	400	-	-	ns	
CSB input setup time	Tcsu	50	-	-	ns	
CSB input hold time	Tchd	50	-	-	ns	

## 2.4 Data Format

### 2.4.1 Parallel RGB Input Timing Diagram

(HV Mode)

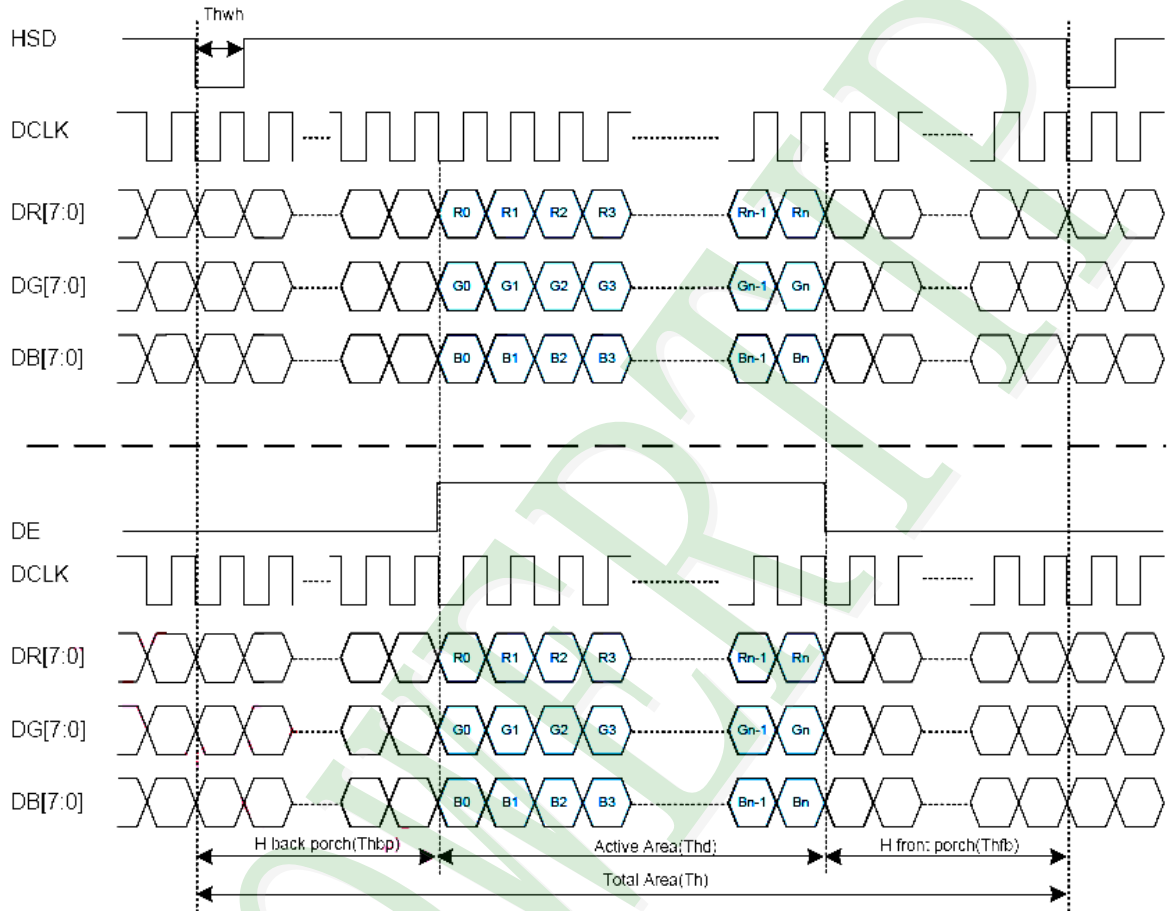

### 2.4.2 Parallel RGB Input Timing Table

Parameter	Symbol	Value			Unit
		Min.	Typ.	Max.	
DCLK frequency	fclk	5	9	12	MHz
VSD period time	Tv	277	288	400	H
VSD display area	Tvd	272			H
VSD back porch	Tvb	3	8	31	H
VSD front porch	Tvfp	2	8	97	H
HSD period time	Th	520	525	800	DCLK
HSD display area	Thd	480			DCLK
HSD back porch	Thbp	36	40	255	DCLK
HSD front porch	Thfp	4	5	65	DCLK

## 2.5 Power On/Off Sequence

### 2.5.1 Power On Sequence

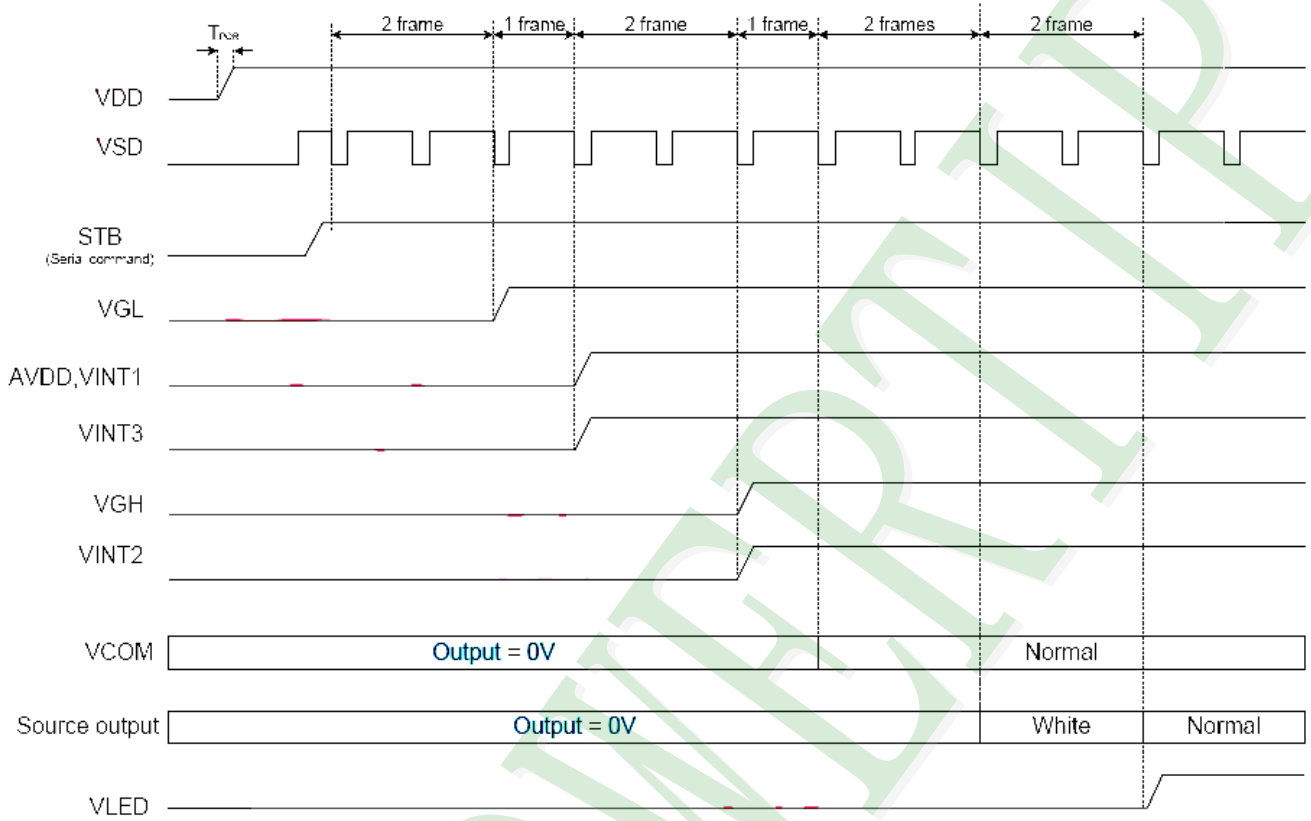

## 2.5.2 Power Off Sequence

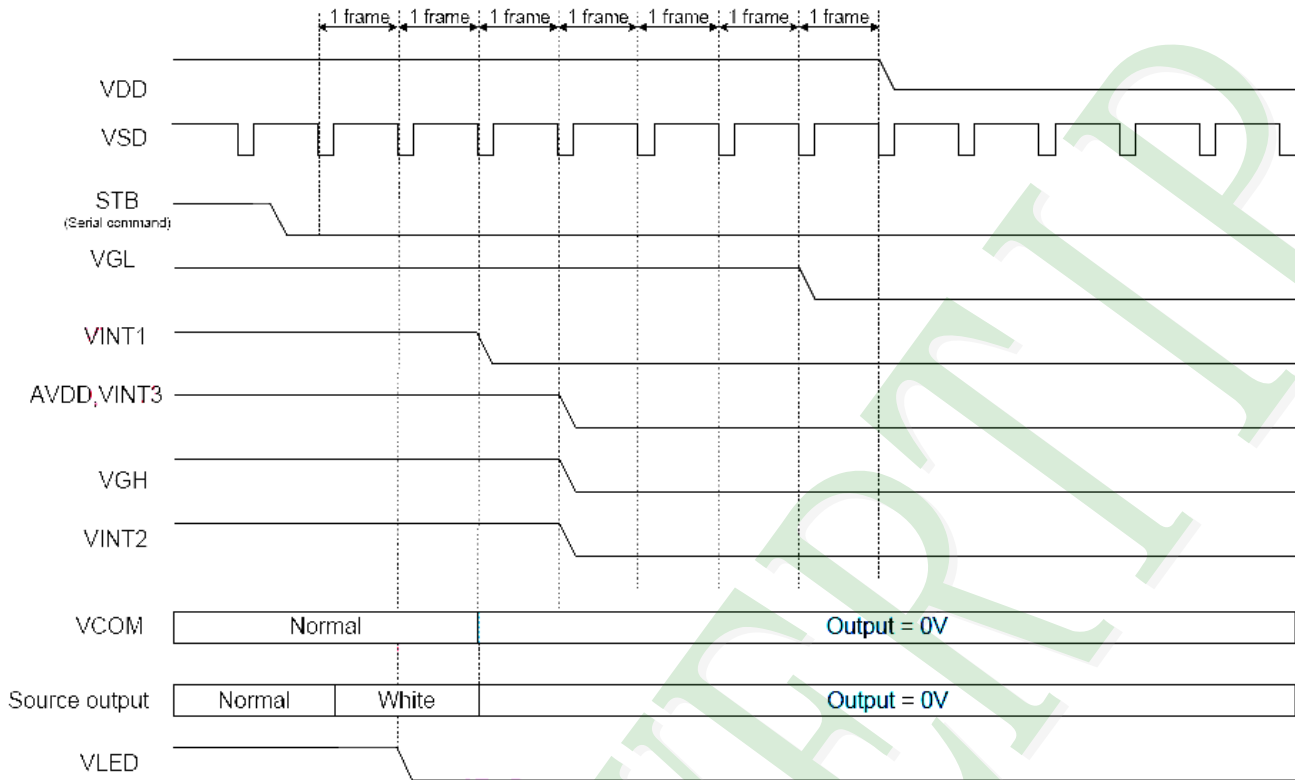

### 3. QUALITY ASSURANCE SYSTEM

#### 3.1 Quality Assurance Flow Chart

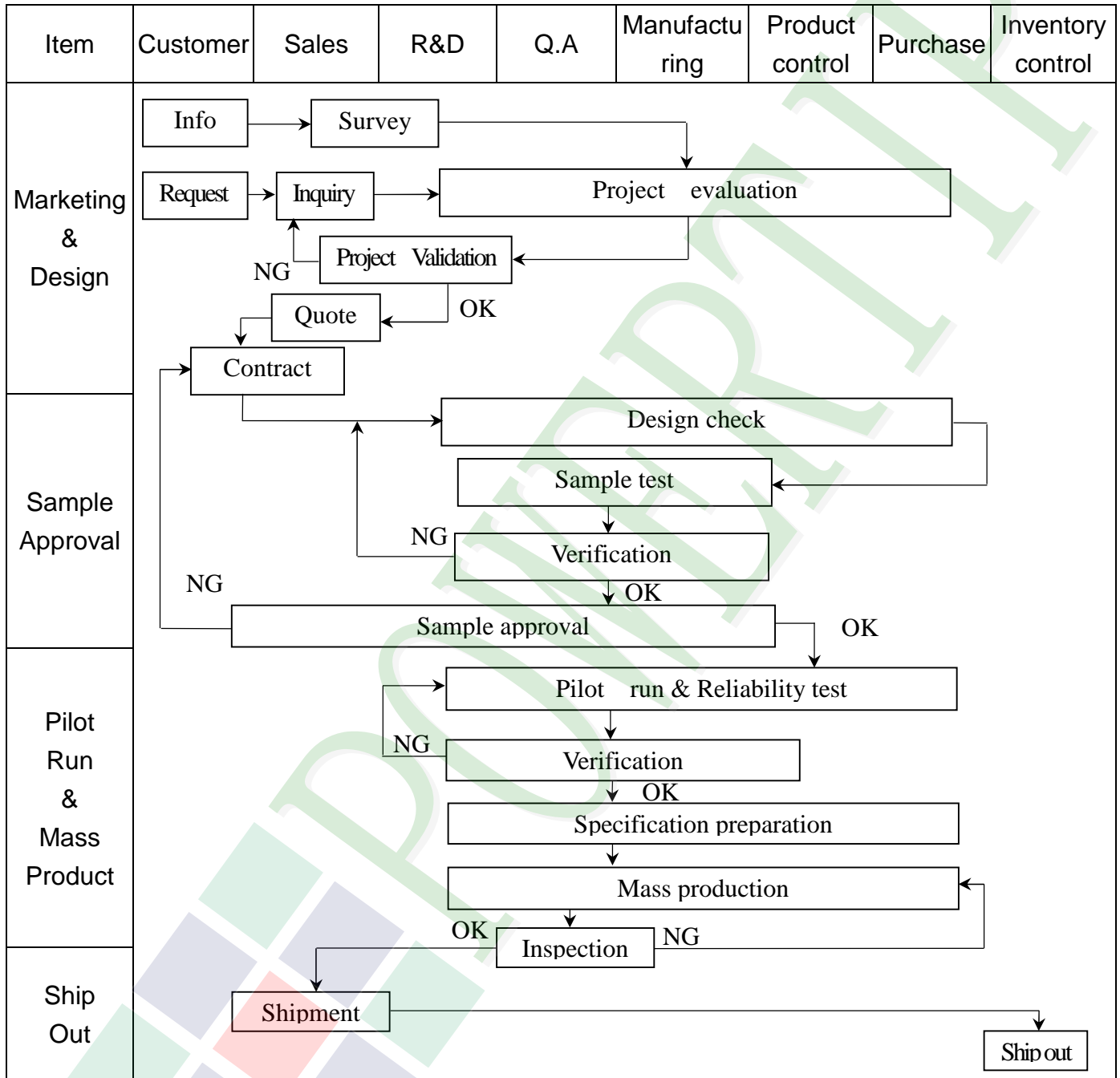

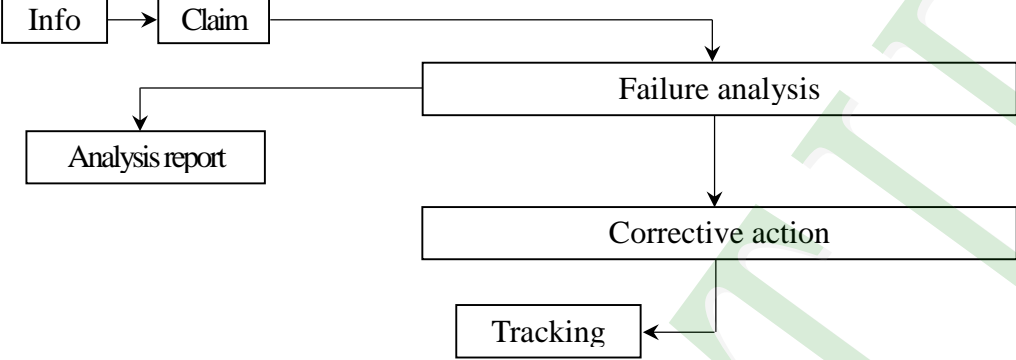
Item	Customer	Sales	R&D	Q.A	Manufacturing	Product control	Purchase	Inventory control
Sales Service	 <pre> graph TD     Info[Info] --&gt; Claim[Claim]     Claim --&gt; FA[Failure analysis]     Claim --&gt; AR[Analysis report]     FA --&gt; CA[Corrective action]     CA --&gt; Tracking[Tracking]           </pre>							
Q.A Activity	1. ISO 9001 Maintenance Activities 3. Equipment calibration 5. Standardization Management				2. Process improvement proposal 4. Education And Training Activities			

### 3.2 Inspection Specification

- ◆ Scope : The document shall be applied to TFT-LCD Module for 3.5" ~10" (Ver.B01).
- ◆ Inspection Standard : MIL-STD-105E Table Normal Inspection Single Sampling Level II.
- ◆ Equipment : Gauge 、 MIL-STD 、 Powertip Tester 、 Sample
- ◆ Defect Level : Major Defect AQL : 0.4 ; Minor Defect AQL : 1.5
- ◆ OUT Going Defect Level : Sampling.
- ◆ Standard of the product appearance test :

a. Manner of appearance test :

- (1). The test best be under 20W×2 fluorescent light , and distance of view must be at 30 cm.
- (2). The test direction is base on about around 45° of vertical line.

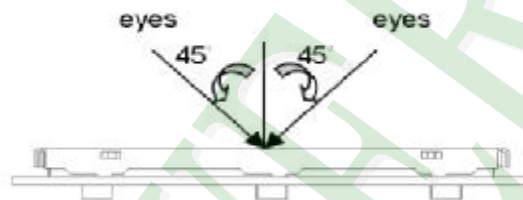

(3). Definition of area.

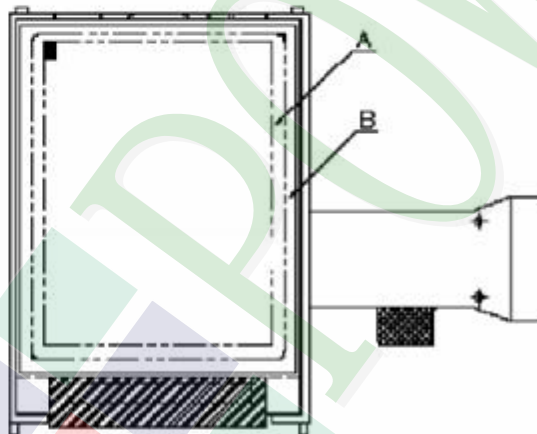

*A* area : viewing area

*B* area : Outside of viewing area

(4). Standard of inspection : (Unit : mm)



## ◆ Specification For TFT-LCD Module 3.5" ~10" :

(Ver.B01)

NO	Item	Criterion	Level										
01	Product condition	1. 1 The part number is inconsistent with work order of production.	Major										
		1. 2 Mixed product types.	Major										
		1. 3 Assembled in inverse direction.	Major										
02	Quantity	2. 1 The quantity is inconsistent with work order of production.	Major										
03	Outline dimension	3. 1 Product dimension and structure must conform to structure diagram.	Major										
		4. 1 Missing line character and icon.	Major										
04	Electrical Testing	4. 2 No function or no display.	Major										
		4. 3 Display malfunction.	Major										
		4. 4 LCD viewing angle defect.	Major										
		4. 5 Current consumption exceeds product specifications.	Major										
05	Dot defect (Bright dot 、 Dark dot)  On -display	<table border="1"> <thead> <tr> <th>Item</th> <th>Acceptance (Q'ty)</th> </tr> </thead> <tbody> <tr> <td>Bright Dot</td> <td><math>\leq 4</math></td> </tr> <tr> <td>Dark Dot</td> <td><math>\leq 5</math></td> </tr> <tr> <td>Joint Dot</td> <td><math>\leq 3</math></td> </tr> <tr> <td>Total</td> <td><math>\leq 7</math></td> </tr> </tbody> </table>	Item	Acceptance (Q'ty)	Bright Dot	$\leq 4$	Dark Dot	$\leq 5$	Joint Dot	$\leq 3$	Total	$\leq 7$	Minor
		Item	Acceptance (Q'ty)										
		Bright Dot	$\leq 4$										
		Dark Dot	$\leq 5$										
		Joint Dot	$\leq 3$										
Total	$\leq 7$												
5. 1 Inspection pattern : full white , full black , Red , Green and blue screens.													
5. 2 It is defined as dot defect if defect area $> 1/2$ dot.													
5. 3 The distance between two dot defect $\geq 5$ mm.													



**◆ Specification For TFT-LCD Module 3.5" -10" :**

(Ver.B01)

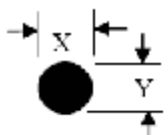
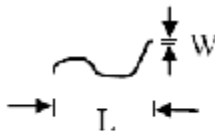
NO	Item	Criterion	Level																						
06	Black or white dot、scratch、contamination  Round type  $\Phi = (x + y) / 2$  Line type 	6.1 Round type ( Non-display or display) :  <table border="1"> <thead> <tr> <th rowspan="2">Dimension (diameter : <math>\Phi</math>)</th> <th colspan="2">Acceptance (Q'ty)</th> </tr> <tr> <th>A area</th> <th>B area</th> </tr> </thead> <tbody> <tr> <td><math>\Phi \leq 0.25</math></td> <td colspan="2">Ignore</td> </tr> <tr> <td><math>0.25 &lt; \Phi \leq 0.50</math></td> <td>5</td> <td rowspan="2">Ignore</td> </tr> <tr> <td><math>\Phi &gt; 0.50</math></td> <td>0</td> </tr> <tr> <td><b>Total</b></td> <td colspan="2">5</td> </tr> </tbody> </table>	Dimension (diameter : $\Phi$ )	Acceptance (Q'ty)		A area	B area	$\Phi \leq 0.25$	Ignore		$0.25 < \Phi \leq 0.50$	5	Ignore	$\Phi > 0.50$	0	<b>Total</b>	5		Minor						
		Dimension (diameter : $\Phi$ )		Acceptance (Q'ty)																					
A area	B area																								
$\Phi \leq 0.25$	Ignore																								
$0.25 < \Phi \leq 0.50$	5	Ignore																							
$\Phi > 0.50$	0																								
<b>Total</b>	5																								
6.2 Line type( Non-display or display) :  <table border="1"> <thead> <tr> <th rowspan="2">Length (L)</th> <th rowspan="2">Width (W)</th> <th colspan="2">Acceptance (Q'ty)</th> </tr> <tr> <th>A area</th> <th>B area</th> </tr> </thead> <tbody> <tr> <td>---</td> <td><math>W \leq 0.03</math></td> <td colspan="2">Ignore</td> </tr> <tr> <td><math>L \leq 10.0</math></td> <td><math>0.03 &lt; W \leq 0.05</math></td> <td>4</td> <td rowspan="2">Ignore</td> </tr> <tr> <td><math>L \leq 5.0</math></td> <td><math>0.05 &lt; W \leq 0.10</math></td> <td>2</td> </tr> <tr> <td>---</td> <td><math>W &gt; 0.10</math></td> <td colspan="2">As round type</td> </tr> <tr> <td colspan="2"><b>Total</b></td> <td colspan="2">5</td> </tr> </tbody> </table>	Length (L)	Width (W)	Acceptance (Q'ty)		A area	B area	---	$W \leq 0.03$	Ignore		$L \leq 10.0$	$0.03 < W \leq 0.05$	4	Ignore	$L \leq 5.0$	$0.05 < W \leq 0.10$	2	---	$W > 0.10$	As round type		<b>Total</b>		5	
Length (L)			Width (W)	Acceptance (Q'ty)																					
	A area	B area																							
---	$W \leq 0.03$	Ignore																							
$L \leq 10.0$	$0.03 < W \leq 0.05$	4	Ignore																						
$L \leq 5.0$	$0.05 < W \leq 0.10$	2																							
---	$W > 0.10$	As round type																							
<b>Total</b>		5																							
07	Polarizer Bubble	<table border="1"> <thead> <tr> <th rowspan="2">Dimension (diameter : <math>\Phi</math>)</th> <th colspan="2">Acceptance (Q'ty)</th> </tr> <tr> <th>A area</th> <th>B area</th> </tr> </thead> <tbody> <tr> <td><math>\Phi \leq 0.25</math></td> <td colspan="2">Ignore</td> </tr> <tr> <td><math>0.25 &lt; \Phi \leq 0.50</math></td> <td>4</td> <td rowspan="2">Ignore</td> </tr> <tr> <td><math>0.50 &lt; \Phi \leq 0.80</math></td> <td>1</td> </tr> <tr> <td><math>\Phi &gt; 0.80</math></td> <td colspan="2">0</td> </tr> <tr> <td><b>Total</b></td> <td colspan="2">5</td> </tr> </tbody> </table>	Dimension (diameter : $\Phi$ )	Acceptance (Q'ty)		A area	B area	$\Phi \leq 0.25$	Ignore		$0.25 < \Phi \leq 0.50$	4	Ignore	$0.50 < \Phi \leq 0.80$	1	$\Phi > 0.80$	0		<b>Total</b>	5		Minor			
Dimension (diameter : $\Phi$ )	Acceptance (Q'ty)																								
	A area	B area																							
$\Phi \leq 0.25$	Ignore																								
$0.25 < \Phi \leq 0.50$	4	Ignore																							
$0.50 < \Phi \leq 0.80$	1																								
$\Phi > 0.80$	0																								
<b>Total</b>	5																								

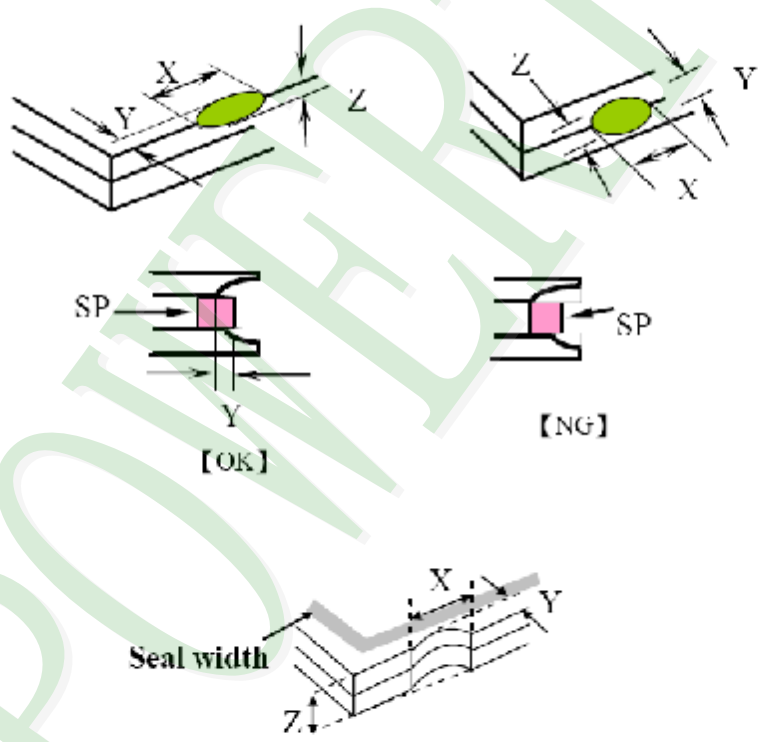
NO	Item	Criterion	Level						
08	The crack of glass	<p><b>Symbols :</b></p> <p><b>X :</b> The length of crack  <b>Z :</b> The thickness of crack  <b>t :</b> The thickness of glass</p> <p><b>Y :</b> The width of crack.  <b>W :</b> terminal length  <b>a :</b> LCD side length</p>	Minor						
		<p>8.1 General glass chip :</p> <p>8.1.1 Chip on panel surface and crack between panels:</p>  <table border="1" data-bbox="542 1545 1340 1836"> <thead> <tr> <th>X</th> <th>Y</th> <th>Z</th> </tr> </thead> <tbody> <tr> <td><math>\leq a</math></td> <td>Crack can't enter viewing area</td> <td><math>\leq 1/2 t</math></td> </tr> <tr> <td><math>\leq a</math></td> <td>Crack can't exceed the half of SP width.</td> <td><math>1/2 t &lt; Z \leq 2 t</math></td> </tr> </tbody> </table>		X	Y	Z	$\leq a$	Crack can't enter viewing area	$\leq 1/2 t$
X	Y	Z							
$\leq a$	Crack can't enter viewing area	$\leq 1/2 t$							
$\leq a$	Crack can't exceed the half of SP width.	$1/2 t < Z \leq 2 t$							

**◆ Specification For TFT-LCD Module 3.5" ~10" :**

(Ver.B01)

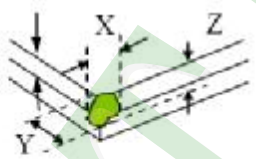
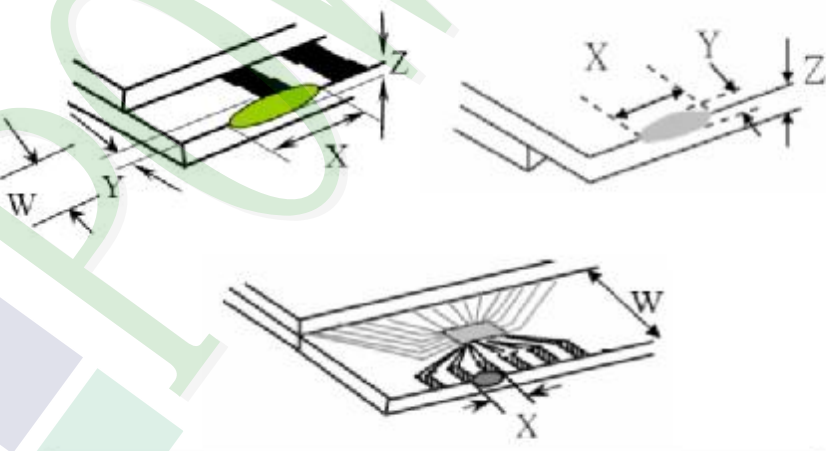
NO	Item	Criterion	Level												
08	The crack of glass	<p><b>Symbols :</b></p> <p><b>X :</b> The length of crack  <b>Z :</b> The thickness of crack  <b>t :</b> The thickness of glass</p> <p><b>Y :</b> The width of crack.  <b>W :</b> terminal length  <b>a :</b> LCD side length</p> <hr/> <p>8.1.2 Corner crack :</p>  <table border="1" data-bbox="523 757 1332 1048"> <thead> <tr> <th>X</th> <th>Y</th> <th>Z</th> </tr> </thead> <tbody> <tr> <td><math>\leq 1/5 a</math></td> <td>Crack can't enter viewing area</td> <td><math>Z \leq 1/2 t</math></td> </tr> <tr> <td><math>\leq 1/5 a</math></td> <td>Crack can't exceed the half of SP width.</td> <td><math>1/2 t &lt; Z \leq 2 t</math></td> </tr> </tbody> </table>	X	Y	Z	$\leq 1/5 a$	Crack can't enter viewing area	$Z \leq 1/2 t$	$\leq 1/5 a$	Crack can't exceed the half of SP width.	$1/2 t < Z \leq 2 t$				
		X	Y	Z											
$\leq 1/5 a$	Crack can't enter viewing area	$Z \leq 1/2 t$													
$\leq 1/5 a$	Crack can't exceed the half of SP width.	$1/2 t < Z \leq 2 t$													
		<p>8.2 Protrusion over terminal :</p> <p>8.2.1 Chip on electrode pad :</p>  <table border="1" data-bbox="561 1675 1343 1848"> <thead> <tr> <th></th> <th>X</th> <th>Y</th> <th>Z</th> </tr> </thead> <tbody> <tr> <td>Front</td> <td><math>\leq a</math></td> <td><math>\leq 1/2 W</math></td> <td><math>\leq t</math></td> </tr> <tr> <td>Back</td> <td><math>\leq a</math></td> <td><math>\leq W</math></td> <td><math>\leq 1/2 t</math></td> </tr> </tbody> </table>		X	Y	Z	Front	$\leq a$	$\leq 1/2 W$	$\leq t$	Back	$\leq a$	$\leq W$	$\leq 1/2 t$	Minor
	X	Y	Z												
Front	$\leq a$	$\leq 1/2 W$	$\leq t$												
Back	$\leq a$	$\leq W$	$\leq 1/2 t$												

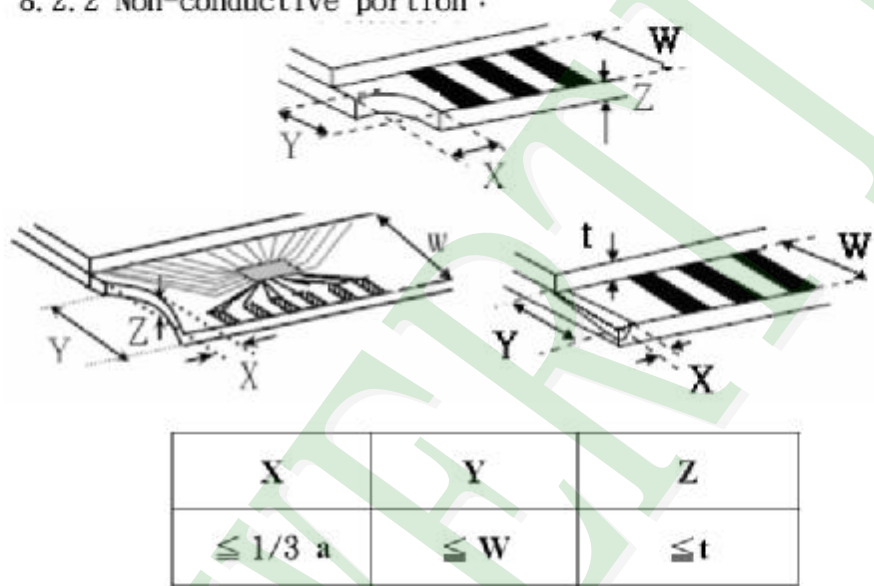
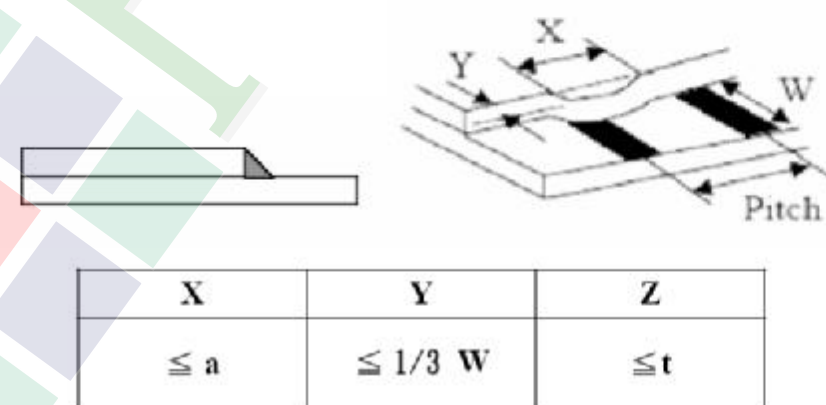
NO	Item	Criterion	Level												
08	The crack of glass	<p><b>Symbols :</b></p> <p><b>X :</b> The length of crack  <b>Z :</b> The thickness of crack  <b>t :</b> The thickness of glass</p> <p><b>Y :</b> The width of crack.  <b>W :</b> terminal length  <b>a :</b> LCD side length</p> <hr/> <p>8.2.2 Non-conductive portion :</p>  <p style="text-align: center;"> <table border="1" style="margin-left: auto; margin-right: auto;"> <tr> <td style="padding: 5px;"><b>X</b></td> <td style="padding: 5px;"><b>Y</b></td> <td style="padding: 5px;"><b>Z</b></td> </tr> <tr> <td style="padding: 5px;"><math>\leq 1/3 a</math></td> <td style="padding: 5px;"><math>\leq W</math></td> <td style="padding: 5px;"><math>\leq t</math></td> </tr> </table> </p> <p>⊙ If the chipped area touches the ITO terminal, over 2/3 of the ITO must remain and be inspected according to electrode terminal specifications.</p> <p>8.2.3 Glass remain :</p>  <p style="text-align: center;"> <table border="1" style="margin-left: auto; margin-right: auto;"> <tr> <td style="padding: 5px;"><b>X</b></td> <td style="padding: 5px;"><b>Y</b></td> <td style="padding: 5px;"><b>Z</b></td> </tr> <tr> <td style="padding: 5px;"><math>\leq a</math></td> <td style="padding: 5px;"><math>\leq 1/3 W</math></td> <td style="padding: 5px;"><math>\leq t</math></td> </tr> </table> </p>	<b>X</b>	<b>Y</b>	<b>Z</b>	$\leq 1/3 a$	$\leq W$	$\leq t$	<b>X</b>	<b>Y</b>	<b>Z</b>	$\leq a$	$\leq 1/3 W$	$\leq t$	Minor
		<b>X</b>	<b>Y</b>	<b>Z</b>											
$\leq 1/3 a$	$\leq W$	$\leq t$													
<b>X</b>	<b>Y</b>	<b>Z</b>													
$\leq a$	$\leq 1/3 W$	$\leq t$													

**◆Specification For TFT-LCD Module 3.5" ~10" :**

(Ver.B01)

NO	Item	Criterion	Level
09	Backlight elements	9. 1 Backlight can't work normally.	Major
		9. 2 Backlight doesn't light or color is wrong.	Major
		9. 3 Illumination source flickers when lit.	Major
10	General appearance	10. 1 Pin type 、 quantity 、 dimension must match type in structure diagram.	Major
		10. 2 No short circuits in components on PCB or FPC .	Major
		10.3 Parts on PCB or FPC must be the same as on the production characteristic chart .There should be no wrong parts , missing parts or excess parts.	Major
		10. 4 Product packaging must the same as specified on packaging specification sheet.	Minor
		10. 5 The folding and peeled off in polarizer are not acceptable.	Minor
		10. 6 The PCB or FPC between B/L assembled distance(PCB or FPC ) is $\leq 1.5$ mm.	Minor

## 4. RELIABILITY TEST

### 4.1 Reliability Test Condition

**(Ver.B01)**

NO.	TEST ITEM	TEST CONDITION										
1	High Temperature Storage Test	Keep in <b>+80 ±2°C</b> 96 hrs Surrounding temperature, then storage at normal condition 4hrs.										
2	Low Temperature Storage Test	Keep in <b>-30 ±2°C</b> 96 hrs Surrounding temperature, then storage at normal condition 4hrs.										
3	High Temperature / High Humidity Storage Test	Keep in <b>+60 °C / 90% R.H</b> duration for 96 hrs Surrounding temperature, then storage at normal condition 4hrs. (Excluding the polarizer)										
4	Temperature Cycling Storage Test	<p style="text-align: center;"> <math display="block">-30^{\circ}\text{C} \xrightarrow{(30\text{mins})} +25^{\circ}\text{C} \xrightarrow{(5\text{mins})} +80^{\circ}\text{C} \xrightarrow{(30\text{mins})} +25^{\circ}\text{C} \xrightarrow{(5\text{mins})}</math>           ←----- 10 Cycle -----→         </p> <p>Surrounding temperature, then storage at normal condition 4hrs.</p>										
5	ESD Test	<b>Air Discharge:</b> Apply <b>2 KV</b> with 5 times Discharge for each polarity +/-										
		<b>Contact Discharge:</b> Apply <b>250 V</b> with 5 times discharge for each polarity +/-										
		1. <b>Temperature ambience :</b> 15°C ~ 35°C 2. <b>Humidity relative :</b> 30% ~ 60% 3. <b>Energy Storage Capacitance(Cs+Cd) :</b> 150pF±10% 4. <b>Discharge Resistance(Rd) :</b> 330Ω±10% 5. <b>Discharge, mode of operation :</b> Single Discharge (time between successive discharges at least 1 sec) (Tolerance if the output voltage indication : ±5%)										
6	Vibration Test (Packaged)	1. Sine wave <b>10~55 Hz</b> frequency (1 min/sweep) 2. The amplitude of vibration : <b>1.5 mm</b> 3. Each direction (X、Y、Z) duration for <b>2 Hrs</b>										
7	Drop Test (Packaged)	<table border="1"> <thead> <tr> <th>Packing Weight (Kg)</th> <th>Drop Height (cm)</th> </tr> </thead> <tbody> <tr> <td>0 ~ 45.4</td> <td>122</td> </tr> <tr> <td>45.4 ~ 90.8</td> <td>76</td> </tr> <tr> <td>90.8 ~ 454</td> <td>61</td> </tr> <tr> <td>Over 454</td> <td>46</td> </tr> </tbody> </table> <p>Drop Direction :※1 corner / 3 edges / 6 sides each 1time</p>	Packing Weight (Kg)	Drop Height (cm)	0 ~ 45.4	122	45.4 ~ 90.8	76	90.8 ~ 454	61	Over 454	46
Packing Weight (Kg)	Drop Height (cm)											
0 ~ 45.4	122											
45.4 ~ 90.8	76											
90.8 ~ 454	61											
Over 454	46											

## 5. PRECAUTION RELATING PRODUCT HANDLING

### 5.1 SAFETY

- 5.1.1 If the LCD panel breaks , be careful not to get the liquid crystal to touch your skin.
- 5.1.2 If the liquid crystal touches your skin or clothes , please wash it off immediately by using soap and water.

### 5.2 HANDLING

- 5.2.1 Avoid any strong mechanical shock which can break the glass.
- 5.2.2 Avoid static electricity which can damage the CMOS LSI—When working with the module , be sure to ground your body and any electrical equipment you may be using.
- 5.2.3 Do not remove the panel or frame from the module.
- 5.2.4 The polarizing plate of the display is very fragile. So , please handle it very carefully ,do not touch , push or rub the exposed polarizing with anything harder than an HB pencil lead (glass , tweezers , etc.)
- 5.2.5 Do not wipe the polarizing plate with a dry cloth , as it may easily scratch the surface of plate.
- 5.2.6 Do not touch the display area with bare hands , this will stain the display area.
- 5.2.7 Do not use ketonics solvent & aromatic solvent. Use with a soft cloth soaked with a cleaning naphtha solvent.
- 5.2.8 To control temperature and time of soldering is  $320\pm 10^{\circ}\text{C}$  and 3-5 sec.
- 5.2.9 To avoid liquid (include organic solvent) stained on LCM .

### 5.3 STORAGE

- 5.3.1 Store the panel or module in a dark place where the temperature is  $25^{\circ}\text{C} \pm 5^{\circ}\text{C}$  and the humidity is below 65% RH.
- 5.3.2 Do not place the module near organics solvents or corrosive gases.
- 5.3.3 Do not crush , shake , or jolt the module.

### 5.4 TERMS OF WARRANTY

- 5.4.1 Applicable warrant period  
The period is within thirteen months since the date of shipping out under normal using and storage conditions.
- 5.4.2 Unaccepted responsibility  
This product has been manufactured to your company's specification as a part for use in your company's general electronic products. It is guaranteed to perform according to delivery specifications. For any other use apart from general electronic equipment , we cannot take responsibility if the product is used in nuclear power control equipment , aerospace equipment , fire and security systems or any other applications in which there is a direct risk to human life and where extremely high levels of reliability are required.

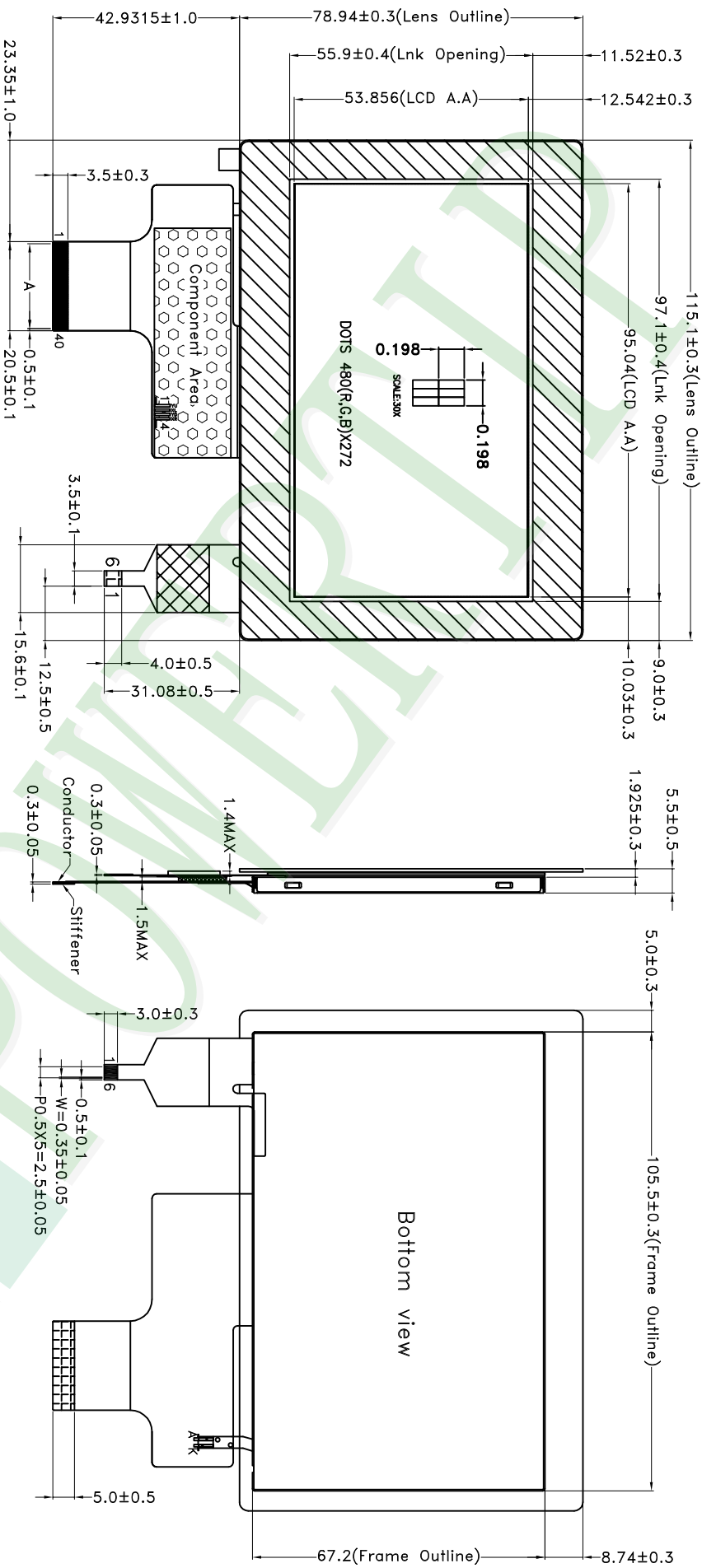

- NOTES:
- 1.LCD TYPE: a-Si TFT
  - 2.LCD DISPLAY: POSITIVE/TRANSMISSIVE
  - 3.VIEW DIRECTION: 6 O'CLOCK
  - 4.Top: -20~70°C Tst: -30~80°C
  - 5.The tolerance unless classified  $\pm 0.3\text{mm}$
  - 6.A: PITCH: 0.5X39=19.5±0.05, W=0.35±0.05
  - 7.FPC PIN CN : ENTERY: 6701K-E40N-00L OR EQUIVALENT
  - 8.T/P PIN CN : ENTERY: 6701K-E06N-00L OR EQUIVALENT

No Pin	Name Description
1	GND Ground
2	SDA I2C Data
3	SCL I2C Clock
4	VDD 3.3V±5%
5	INT active_Low
6	XRES XRES

007																			
006																			
005																			
004																			
003																			
002	Modify TP																		
001	NEW DRAWING																		
REV		REV BY		REVISER		DATE													

PART NO: PH480272T009-IBC01  
 DRAWING NAME: JLMD-PH480272T009-IBC01  
 TITLE: LCD Module Drawing

久正光電股份有限公司  
 POWER TIP TECHNOLOGY CORPORATION

Design	Sally	Unit	MM	Surface		1 ~ 4	
Check	Terry	Scale	FIT	Material		4 ~ 16	
Approve	Ryan	Page	1/1	Thickness		16 ~ 63	
		Quantity				63 ~ 250	
						250 ~ 1000	