



SPECIFICATIONS

CUSTOMER	:	_____
SAMPLE CODE	:	SH800480T024-ICC01
MASS PRODUCTION CODE	:	PH800480T024-ICC01
SAMPLE VERSION	:	01
SPECIFICATIONS EDITION	:	003
DRAWING NO. (Ver.)	:	LMD-PH800480T024-ICC01(Ver.001)
PACKAGING NO. (Ver.)	:	PKG-PH800480T024-ICC01(Ver.001)

Customer Approved

Date: _____

Approved	Checked	Designer
廖志豪 Rex Liao	張慶源 Yuan Chang	陳宗淇 Howard Chen

- Preliminary specification for design input
- Specification for sample approval

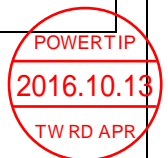

POWERTIP TECH. CORP.

Headquarters: No.8, 6 th Road, Taichung Industrial Park, Taichung, Taiwan 台中市 407 工業區六路 8 號	TEL: 886-4-2355-8168 FAX: 886-4-2355-8166	E-mail: sales@powertip.com.tw Http://www.powertip.com.tw
---	--	--

History of Version

Date (mm / dd / yyyy)	Ver.	Edi.	Description	Page	Design by
01/12/2016	01	001	New Drawing.	-	Howard
04/01/2016	01	002	New Sample	-	Howard
10/12/2016	01	003	Modify CTP IC From FT5306DE4 to FT5426	10	Howard

Total: 34 Pages

Contents

1. SPECIFICATIONS

- 1.1 Features
- 1.2 Mechanical Specifications
- 1.3 Absolute Maximum Ratings
- 1.4 DC Electrical Characteristics
- 1.5 Optical Characteristics
- 1.6 Backlight Characteristics
- 1.7 Touch Panel Specification

2. MODULE STRUCTURE

- 2.1 Counter Drawing
- 2.2 Interface Pin Description
- 2.3 Timing Characteristics

3. QUALITY ASSURANCE SYSTEM

- 3.1 Quality Assurance Flow Chart
- 3.2 Inspection Specification

4. RELIABILITY TEST

- 4.1 Reliability Test Condition

5. PRECAUTION RELATING PRODUCT HANDLING

- 5.1 Safety
- 5.2 Handling
- 5.3 Storage
- 5.4 Terms of Warranty

Appendix : 1.LCM Drawing

2. Packing Specification

Note : For detailed information please refer to IC data sheet :

Primacy(TFT LCD): ILITEK-- ILI6122M-9G / ILI5960-9G

(Or compatible IC)

1. SPECIFICATIONS

1.1 Features

Item	Standard Value
Display Type	800 * 3 (RGB) * 480 Dots
LCD Type	a-Si TFT , Normally white, Transmissive type
Touch Panel	True Multi-Touch Capacitive Touch Panel True Multi-touch with up to 5 Points of Absolution
Screen size(inch)	5.0 inch
Viewing Direction	6 O'clock
Color configuration	RGB-Strip
Backlight Type	LED B/L
Interface	Digital 24-bits RGB
Other(controller/driver IC)	Source IC : ILI6122M-9G / Gate IC: ILI5960-9G (Or Compatible IC)
ROHS	THIS PRODUCT CONFORMS THE ROHS OF PTC Detail information please refer website : http://www.powertip.com.tw/news.php?area_id_view=1085560481/

1.2 Mechanical Specifications

Item	Standard Value	Unit
Outline Dimension	137.0(W) x 96.5 (L) x 5.0(H)(Max)	mm

LCD panel

Item	Standard Value	Unit
Active Area	108.0 (W) x 64.8 (L)	mm
Pixel Size	0.135 (W) * 0.135 (H)	mm

Note : For detailed information please refer to LCM drawing

1.3 Absolute Maximum Ratings

Module

Item	Symbol	Condition	Min.	Max.	Unit
System Power Supply Voltage	VDD	GND=0	-0.3	4.5	V
Operating Temperature	T _{OP}	-	-20	70	°C
Storage Temperature	T _{ST}	-	-30	80	°C
Storage Humidity	H _D	T _a ≦ 60 °C	10	90	%RH

1.4 DC Electrical Characteristics

Module

GND = 0V, T_a = 25 °C

Item	Symbol	Condition	Min.	Typ.	Max.	Unit
Power Supply Voltage	VDD	-	3.0	3.3	3.6	V
Input H/L Level Voltage	V _{IH}	-	0.7VDD	-	VDD	V
	V _{IL}	-	GND	-	0.3VDD	V
Output H/L Level Voltage	V _{OH}	-	VDD-0.4	-	VDD	V
	V _{OL}	-	GND	-	GND+0.4	V
Supply Current	I _{DD}	VDD= 3.3 V Pattern=Photo	-	100	-	mA
		VDD= 3.3 V Pattern=Red *1	-	120	180	mA

Note1:Maximum current display

1.5 Optical Characteristics

TFT LCD Module

VDD= 3.3 V, Ta=25°C

Item		Symbol	Condition	Min.	Typ.	Max.	unit	-
Response time	Tr+Tf	25°C	-	-	35	55	ms	-
Viewing angle	Top	$\theta Y+$	CR \geq 10		60	-	Deg.	Note 4
	Bottom	$\theta Y-$			60	-		
	Left	$\theta X-$			60	-		
	Right	$\theta X+$			60	-		
Contrast ratio		CR		500	600	-	-	Note 3
Color of CIE Coordinate (With B/L & T/P)	White	X	Ta = 25°C $\theta X, \theta Y = 0^\circ$	0.26	0.31	0.36	-	Note1
		Y		0.29	0.34	0.39		
	Red	X		0.50	0.55	0.60		
		Y		0.27	0.32	0.37		
	Green	X		0.29	0.34	0.39		
		Y		0.55	0.60	0.65		
	Blue	X		0.09	0.14	0.19		
		Y		0.03	0.08	0.13		
Average Brightness Pattern=white display (With LCD & T/P)*1		IV	IF= 40 mA	400	500	-	cd/m2	Note1
Uniformity (With LCD & T/P)*2		ΔB	IF= 40 mA	70	-	-	%	Note1

Note 1:

*1 : $\Delta B = B(\text{min}) / B(\text{max}) * 100\%$

*2 : Measurement Condition for Optical Characteristics:

- a : Environment: $25^{\circ}\text{C} \pm 5^{\circ}\text{C}$ / $60 \pm 20\% \text{R.H}$, no wind , dark room below 10 Lux at typical lamp current and typical operating frequency.
- b : Measurement Distance: 500 ± 50 mm , ($\theta = 0^{\circ}$)
- c : Equipment: TOPCON BM-7 fast , (field 1°) , after 10 minutes operation.
- d : The uncertainty of the C.I.E coordinate measurement ± 0.01 , Average Brightness $\pm 4\%$

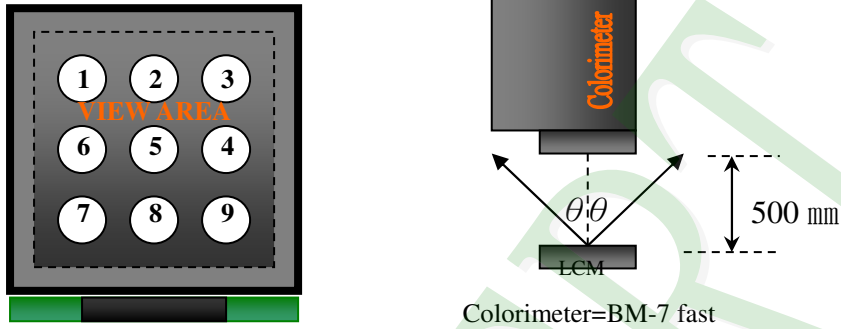

To be measured at the center area of panel with a viewing cone of 1° by Topcon luminance meter BM-7, after 10 minutes operation (module)

Note2: Definition of response time:

The output signals of photo detector are measured when the input signals are changed from "black" to "white"(falling time) and from "white" to "black"(rising time), respectively. The response time is defined as the time interval between the 10% and 90% of Amplitudes.

Refer to figure as below:

Normally White



Normally Black

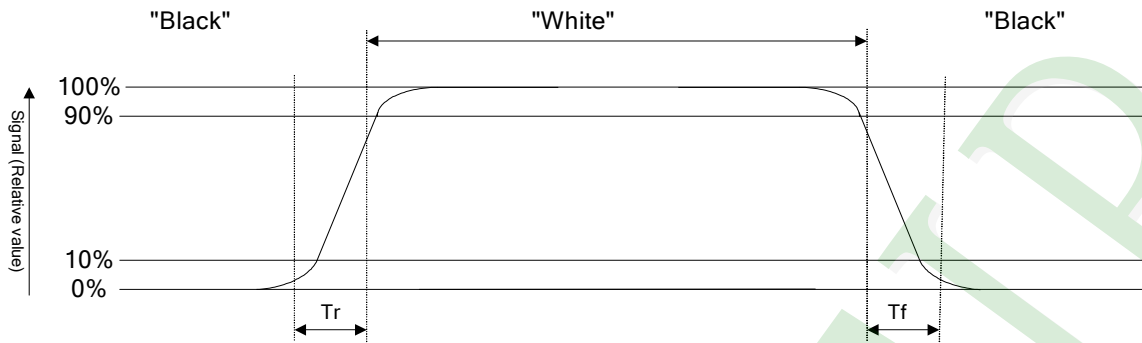

Note3: Definition of contrast ratio:

Contrast ratio is calculated with the following formula

$$\text{Contrast ratio (CR)} = \frac{\text{Photo detector output when LCD is at "White" state}}{\text{Photo detector output when LCD is at "Black" state}}$$

Note4: Definition of viewing angle:

Refer to figure as below:

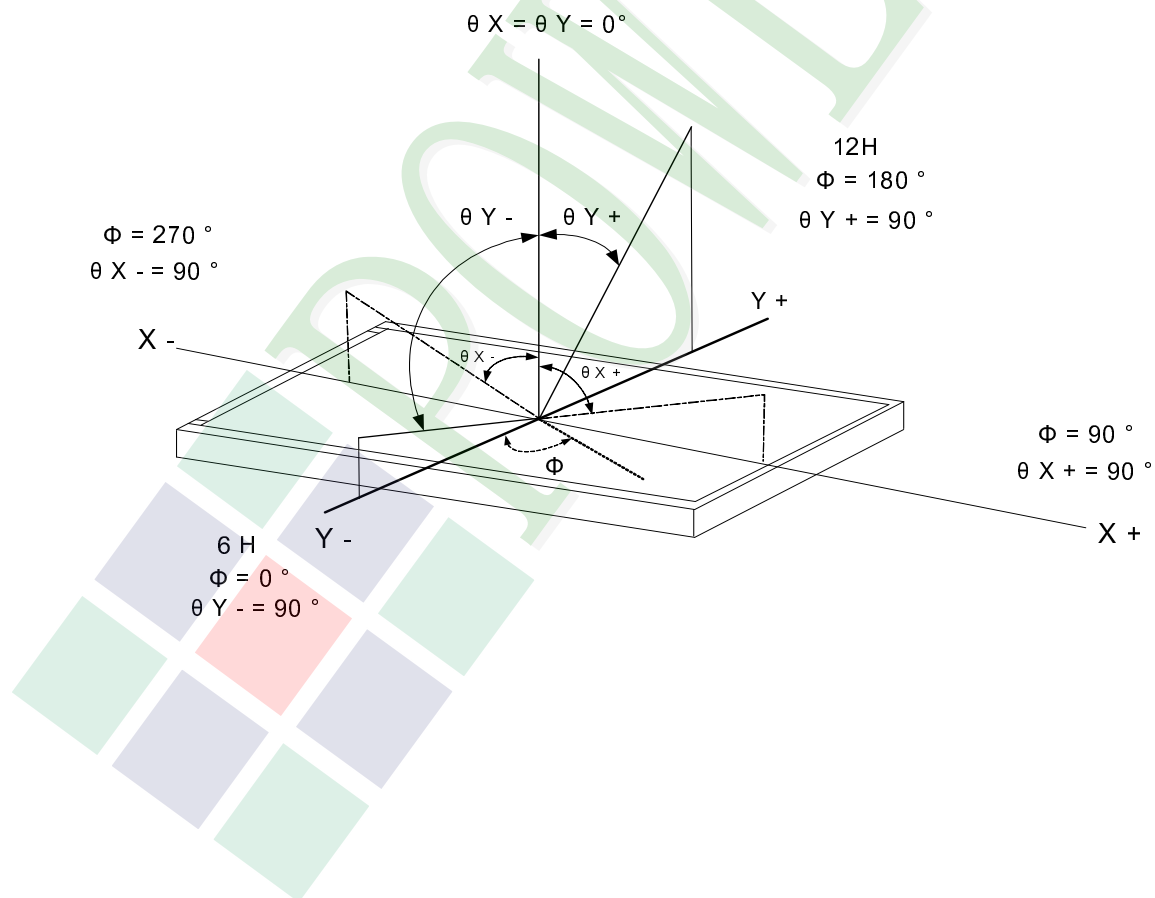

1.6 Backlight Characteristics

Maximum Ratings

Item	Symbol	Conditions	Min.	Max.	Unit
LED Forward Current	IF	Ta =25°C	-	48	mA
LED Reverse Voltage	VR	Ta =25°C	-	5	V
Power Dissipation	PD	Ta =25°C	-	1836	mW

Electrical / Optical Characteristics

Item	Symbol	Conditions	Min.	Typ.	Max.	Unit
Forward Voltage	VF	IF=40mA	26.1	27.9	-	V
Average Brightness (Without LCD)	IV		13500	15500	-	cd/m ²
CIE Color Coordinate (Without LCD)	X		0.25	0.28	0.31	-
	Y		0.25	0.28	0.31	
Color		White				

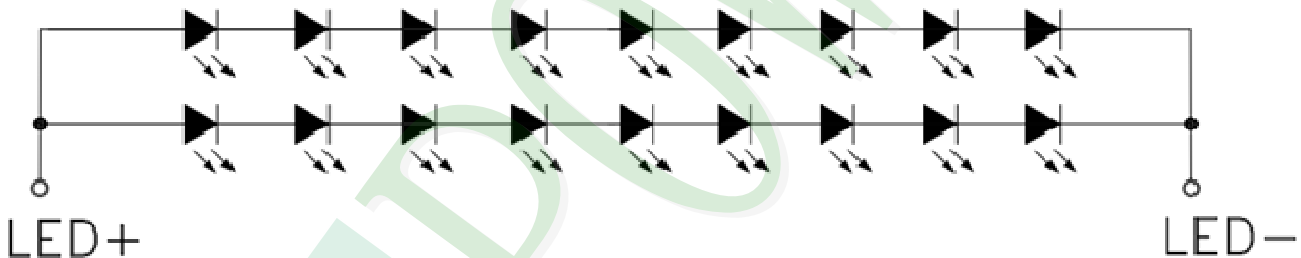

Other Description

Item	Conditions	Description
Life Time	Ta =25°C IF= 40mA	50,000 hrs

1.7 Touch Panel Characteristics

Features

Item	Standard Value
Touch Panel Size	5.0"
Touch type	True Multi-Touch Capacitive Touch Panel
Input Method	True Multi-touch with up to 5 Points of Absolution X and Y Coordinates
Output Interface	I ² C
IC	FT5426

Mechanical Specifications

Item	Standard Value	Unit
Viewing Area	110 mm (W) x 66.8 mm (H)	mm
Number of sensing channel	20 (W) x 12 (H)	mm

Absolute Maximum Ratings

Item	Symbol	Condition	Min.	Max.	Unit
Supply voltage	VDD	-	-0.3	3.6	V
Operating Temperature	T _{OP}	Non condenssing	-20	70	°C
Storage Temperature	T _{ST}	Non condenssing	-30	80	°C

DC Electrical Characteristics

Item	Symbol	Condition	Min.	Typ.	Max.	Unit
Power Supply Voltage	VDD	-	3.0	3.3	3.6	V

Optical Characteristics

Item	Standard Value	Unit
Total light transmittance	83% or more	-
Hardness	≥7H	-

1.7.1 I2C Serial Data Transfer Format

I2C Serial Data Transfer Format

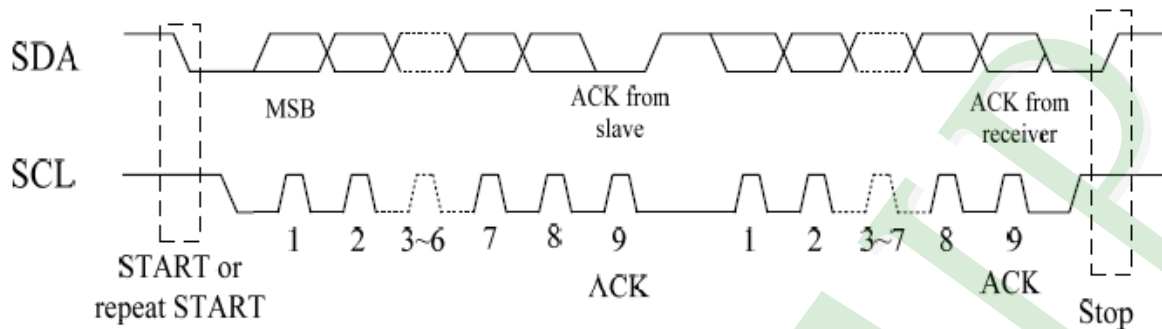

I2C master write, slave read

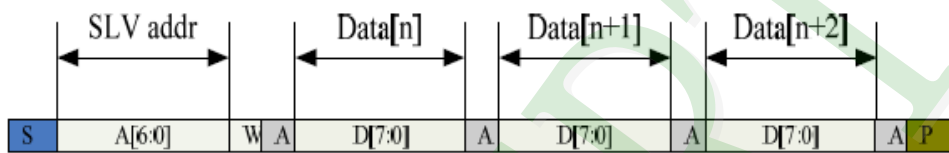

I2C master read, slave write

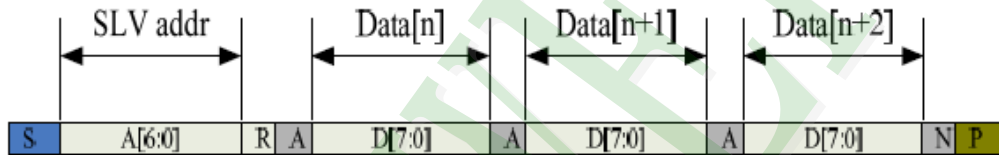

Mnemonics	Description
S	I2C Start or I2C Restart
A[6:0]	Slave address A[6:4]: 3'b011 A[3:0]: data bits are identical to those of I2CCON[7:4] register.
W	1'b0: Write
R	1'b1: Read
A(N)	ACK(NACK)
P	STOP: the indication of the end of a packet (if this bit is missing, S will indicate the end of the current packet and the beginning of the next packet)

Timing Characteristics

Parameter	Unit	Min	Max
SCL frequency	KHz	0	400
Bus free time between a STOP and START condition	us	4.7	\
Hold time (repeated) START condition	us	4.0	\
Data setup time	ns	250	\
Setup time for a repeated START condition	us	4.7	\
Setup Time for STOP condition	us	4.0	\

Power on time

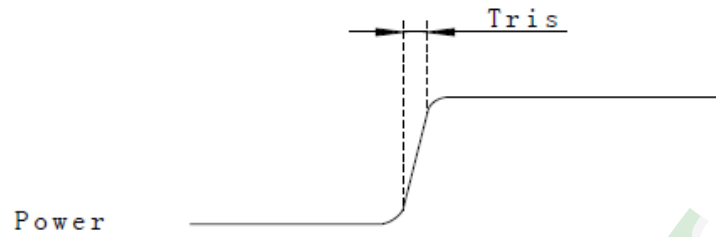

Power on Sequence

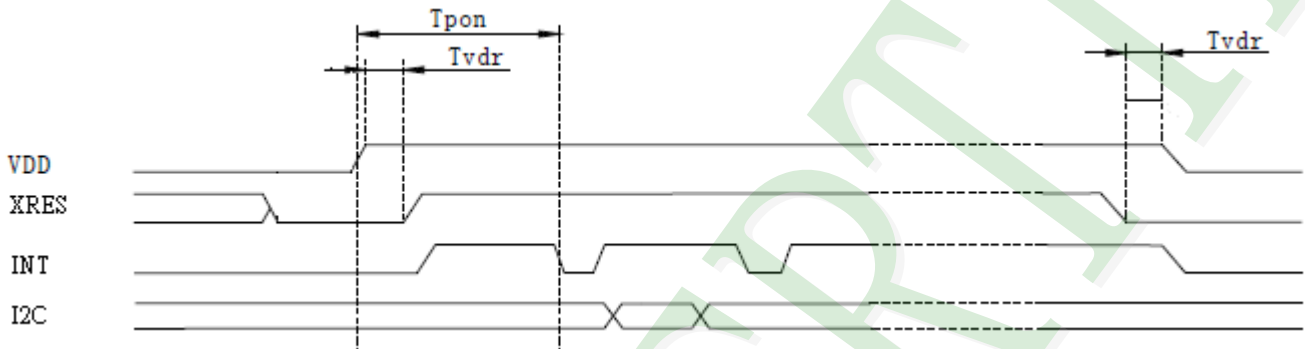

Reset Sequence

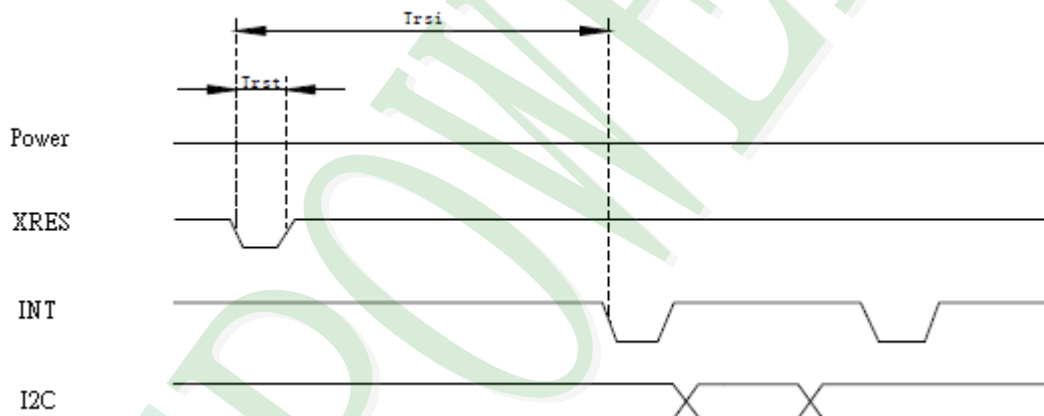

Power on / Reset Sequence Parameters

Parameter	Description	Min	Max	Units
Tris	Rise time from 0.1VDD to 0.9VDD	--	10	ms
Tpon	Time of starting to report point after powering on	300	--	ms
Trsi	Time of starting to report point after resetting	300	--	ms
Trst	Reset time	5	--	ms
Twai	Time of starting to report point after waking	300	--	ms
Twak	Wake up time	5	--	ms

1.7.2 CTP Register Address

Address	Name	Bit7	Bit6	Bit5	Bit4	Bit3	Bit2	Bit1	Bit0	Host Access	
00h	DEVIDE_MODE	Device Mode[2:0]									RW
01h	GEST_ID	Gesture ID[7:0]								R	
02h	ID_STATUS							Number of touch points[3:0]		R	
03h	TOUCH1_XH	1 st Event Flag					1 st Touch X Position[11:8]		R		
04h	TOUCH1_XL	1 st Touch X Position[7:0]								R	
05h	TOUCH1_YH	1 st Touch ID[3:0]			1 st Touch Y Position[11:8]					R	
06h	TOUCH1_YL	1 st Touch Y Position[7:0]								R	
07h											
08h											
09h	TOUCH2_XH	2 nd Event Flag					2 nd Touch X Position[11:8]		R		
0Ah	TOUCH2_XL	2 nd touch X Position[7:0]								R	
0Bh	TOUCH2_YH	2 nd Touch ID[3:0]			2 nd Touch Y Position[11:8]					R	
0Ch	TOUCH2_YL	2 nd Touch Y Position[7:0]								R	
0Dh											
0Eh											
0Fh	TOUCH3_XH	3 rd Event Flag					3 rd Touch X Position[11:8]		R		
10h	TOUCH3_XL	3 rd Touch X Position[7:0]								R	
11h	TOUCH3_YH	3 rd Touch ID[3:0]			3 rd Touch Y Position[11:8]					R	
12h	TOUCH3_YL	3 rd Touch Y Position[7:0]								R	
13h											
14h											



15h	TOUCH4_XH	4 th Event Flag		4 th Touch X Position[11:8]	R
16h	TOUCH4_XL	4 th Touch X Position[7:0]			R
17h	TOUCH4_YH	4 th Touch ID[3:0]		4 th Touch Y Position[11:8]	R
18h	TOUCH4_YL	4 th Touch Y Position[7:0]			R
19h					R
1Ah					R
1Bh	TOUCH5_XH	5 th Event Flag		5 th Touch X Position[11:8]	R
1Ch	TOUCH5_XL	5 th Touch X Position[7:0]			R
1Dh	TOUCH5_YH	5 th Touch ID[3:0]		5 th Touch Y Position[11:8]	R
1Eh	TOUCH5_YL	5 th Touch Y Position[7:0]			R
1Fh					R
20h					R
21h	TOUCH6_XH	6 th Event Flag		6 th Touch X Position[11:8]	
22h	TOUCH6_XL	6 th Touch X Position[7:0]			
23h	TOUCH6_YH	6 th Touch ID[3:0]		6 th Touch Y Position[11:8]	
24h	TOUCH6_YL	6 th Touch Y Position[7:0]			
25h					
26h					
27h	TOUCH7_XH	7 th Event Flag		7 th Touch X Position[11:8]	
28h	TOUCH7_XL	7 th Touch X Position[7:0]			
29h	TOUCH7_YH	7 th Touch ID[3:0]		7 th Touch Y Position[11:8]	
2Ah	TOUCH7_YL	7 th Touch Y Position[7:0]			
2Bh					
2Ch					
2Dh	TOUCH8_XH	8 th Event Flag		8 th Touch X Position[11:8]	
2Eh	TOUCH8_XL	8 th Touch X Position[7:0]			
2Fh	TOUCH8_YH	8 th Touch ID[3:0]		8 th Touch Y Position[11:8]	
30h	TOUCH8_YL	8 th Touch Y Position[7:0]			
31h					
32h					

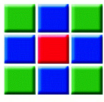

33h	TOUCH9_XH	9 th Event Flag		9 th Touch X Position[11:8]	
34h	TOUCH9_XL	9 th Touch X Position[7:0]			
35h	TOUCH9_YH	9 th Touch ID[3:0]		9 th Touch Y Position[11:8]	
36h	TOUCH9_YL	9 th Touch Y Position[7:0]			
37h					
38h					
39h	TOUCH10_XH	10 th Event Flag		10 th Touch X Position[11:8]	
3Ah	TOUCH10_XL	10 th Touch X Position[7:0]			
3Bh	TOUCH10_YH	10 th Touch ID[3:0]		10 th Touch Y Position[11:8]	
3Ch	TOUCH10_YL	10 th Touch Y Position[7:0]			
3Dh					
3Eh					
3Fh	Reserved				
...	...				
7Fh	Reserved				
80h	ID_G_THGROUP	valid touching detect threshold.			R/W
81h	ID_G_THPEAK	valid touching peak detect threshold.			R/W
82h	ID_G_THCAL	the threshold when calculating the focus of touching.			R/W
83h	ID_G_THWATER	the threshold when there is surface water.			R/W
84h	ID_G_THTEMP	the threshold of temperature compensation.			R/W
85h					R/W
86h	ID_G_CTRL			Power control mode[1:0]	R/W
87h	ID_G_TIME_ENTER_MONITOR	The timer of entering monitor status			R/W
88h	ID_G_PERIODACTIVE			Period Active[3:0]	R/W
89h	ID_G_PERIODMONITOR	The timer of entering idle while in monitor status			R/W
8Ah					R/W
8Bh					R/W
8Ch					R/W
8Dh					R/W
8Eh					R/W
8Fh					R/W
90h					R/W

91h			R/W
92h			R/W
93h			R/W
94h			R/W
95h			R/W
96h			R/W
97h			R/W
98h			R/W
99h			R/W
9Ah			R/W
9Bh			R/W
9Ch			R/W
9Dh			R/W
9Eh			R/W
9Fh			R/W
A0h	ID_G_AUTO_CLB_MODE	auto calibration mode	R/W
A1h	ID_G_LIB_VERSION_H	Firmware Library Version H byte	R
A2h	ID_G_LIB_VERSION_L	Firmware Library Version L byte	R
A3h	ID_G_CIPHER	Chip vendor ID	R
A4h	ID_G_MODE	the interrupt status to host	R
A5h	ID_G_PMODE	Power Consume Mode	
A6h	ID_G_FIRMID	Firmware ID	R
A7h	ID_G_STATE	Running State	
A8h	ID_G_FT5201ID	CTPM Vendor ID	R
A9h	ID_G_ERR	Error Code	R
AAh	ID_G_CLB	Configure TP module during calibration in Test Mode	R/W
ABh			R/W
ACH			R/W
ADh			R/W
AEh	ID_G_B_AREA_TH	The threshold of big area	R/W
AFh			R/W
...	...		
FDh	Reserved		
FEh	LOG_MSG_CNT	The log MSG count	R
FFh	LOG_CUR_CHA	Current character of log message, will point to the next character when one character is read.	R

2. MODULE STRUCTURE

2.1 Counter Drawing

2.1.1 LCM Mechanical Diagram

* See Appendix

2.1.2 Block Diagram

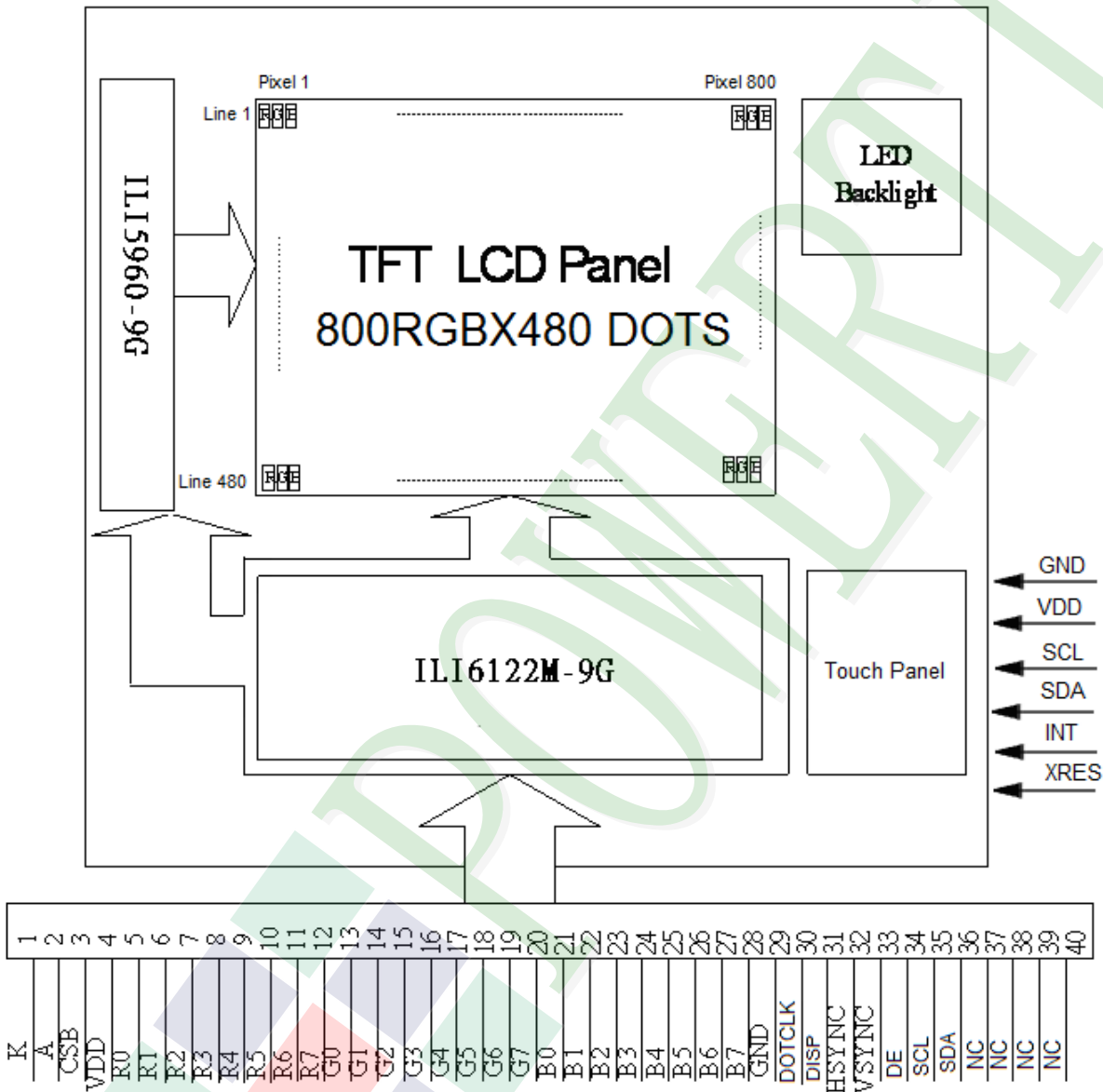

2.2 Interface Pin Description

Pin No.	Symbol	Function
1	LED-	Power supply for LED Backlight cathode input
2	LED+	Power supply for LED Backlight anode input
3	CS(NC)	Chip select pin of serial interface.
4	VDD	Digital power
5	R0	Red data bit 0
6	R1	Red data bit 1
7	R2	Red data bit 2
8	R3	Red data bit 3
9	R4	Red data bit 4
10	R5	Red data bit 5
11	R6	Red data bit 6
12	R7	Red data bit 7
13	G0	Green data bit 0
14	G1	Green data bit 1
15	G2	Green data bit 2
16	G3	Green data bit 3
17	G4	Green data bit 4
18	G5	Green data bit 5
19	G6	Green data bit 6
20	G7	Green data bit 7

Pin No.	Symbol	Function
21	B0	Blue data bit 0
22	B1	Blue data bit 1
23	B2	Blue data bit 2
24	B3	Blue data bit 3
25	B4	Blue data bit 4
26	B5	Blue data bit 5
27	B6	Blue data bit 6
28	B7	Blue data bit 7
29	GND	Ground
30	DOTCLK	Dot data clock, latching data at the rising edge
31	DISP	Display on/ off
32	HSYNC	Horizontal sync input
33	VSYNC	Vertical sync input
34	DE	Data enable
35	SCL(NC)	Data input and output in Serial communication/No connection when no using serial communication
36	SDA(NC)	Clock input in Serial communication / No connection when no using serial communication
37	NC	Not Connect
38	NC	Not Connect
39	NC	Not Connect
40	NC	Not Connect

Touch Panel Driving

Pin No.	Symbol	Function
1	GND	Touch Panel output pin.
2	VDD	Power Supply Voltage (3.3V)
3	SCL	I2C Clock
4	SDA	I2C Data
5	INT	Active Low
6	XRES	Active low global reset signal input.

2.3 Timing Characteristics

2.3.1 Vertical input timing

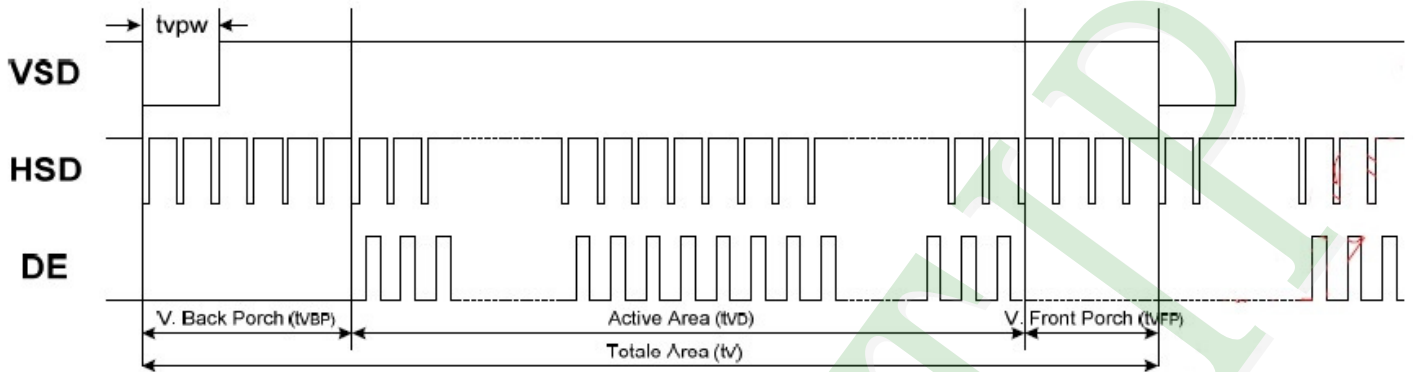

Parameter	Symbol	Value			Unit
		Min	Typ	Max	
Vertical display area	tvd		480		H
VSD period time	tv	510	525	650	H
VSD pulse width	tvpw	1	-	20	H
VSD Back Porch(Blanking)	tvb	23	23	23	H
VSD Front Proch	tvfb	7	22	147	H

2.3.2 Horizontal input timing

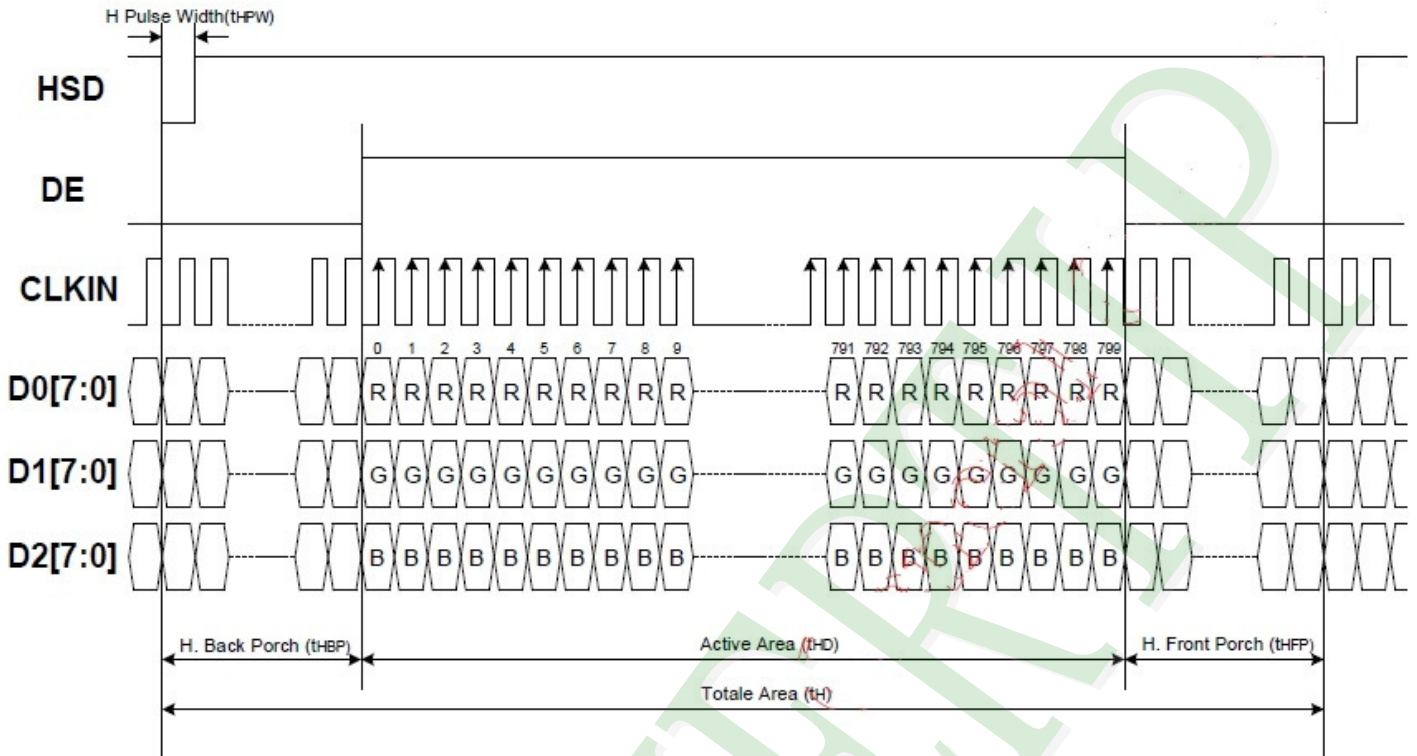

Parameter	Symbol	Value			Unit
		Min	Typ	Max	
Horizontal display area	thd		800		DCLK
DCLK frequency	fclk	-	33.3	50	MHz
1 Horizontal Line	th	862	1056	1200	DCLK
HSD pulse width	Min	-	1		
	Typ	-	-		
	Max	-	40		
HSD Back Porch (Blacking)	thp	46	46	46	
HSD Front Proch	thfb	16	210	354	

2.3.2 Input Clock and Data Timing

DE Mode

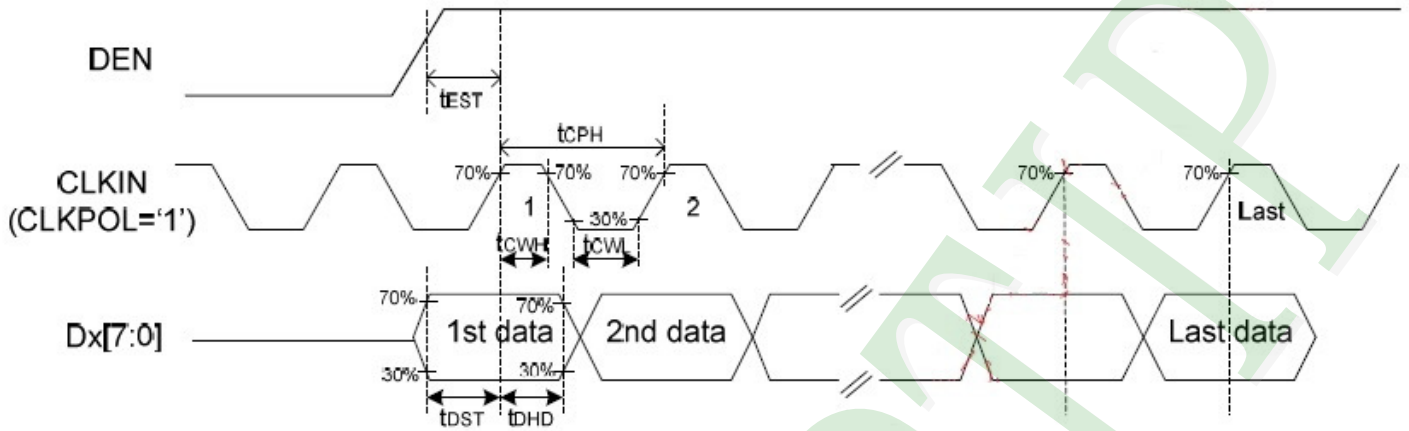

SYNC Mode

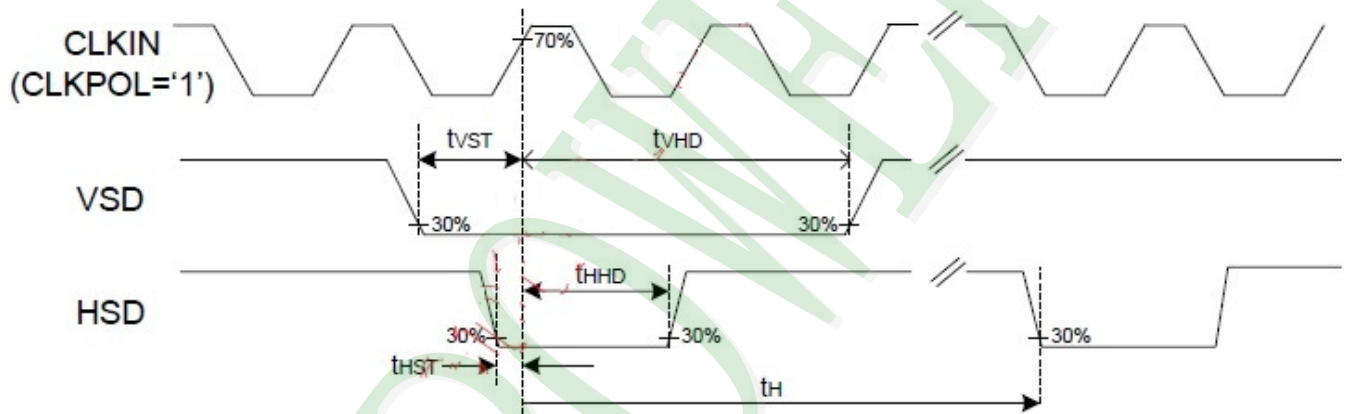

3. QUALITY ASSURANCE SYSTEM

3.1 Quality Assurance Flow Chart

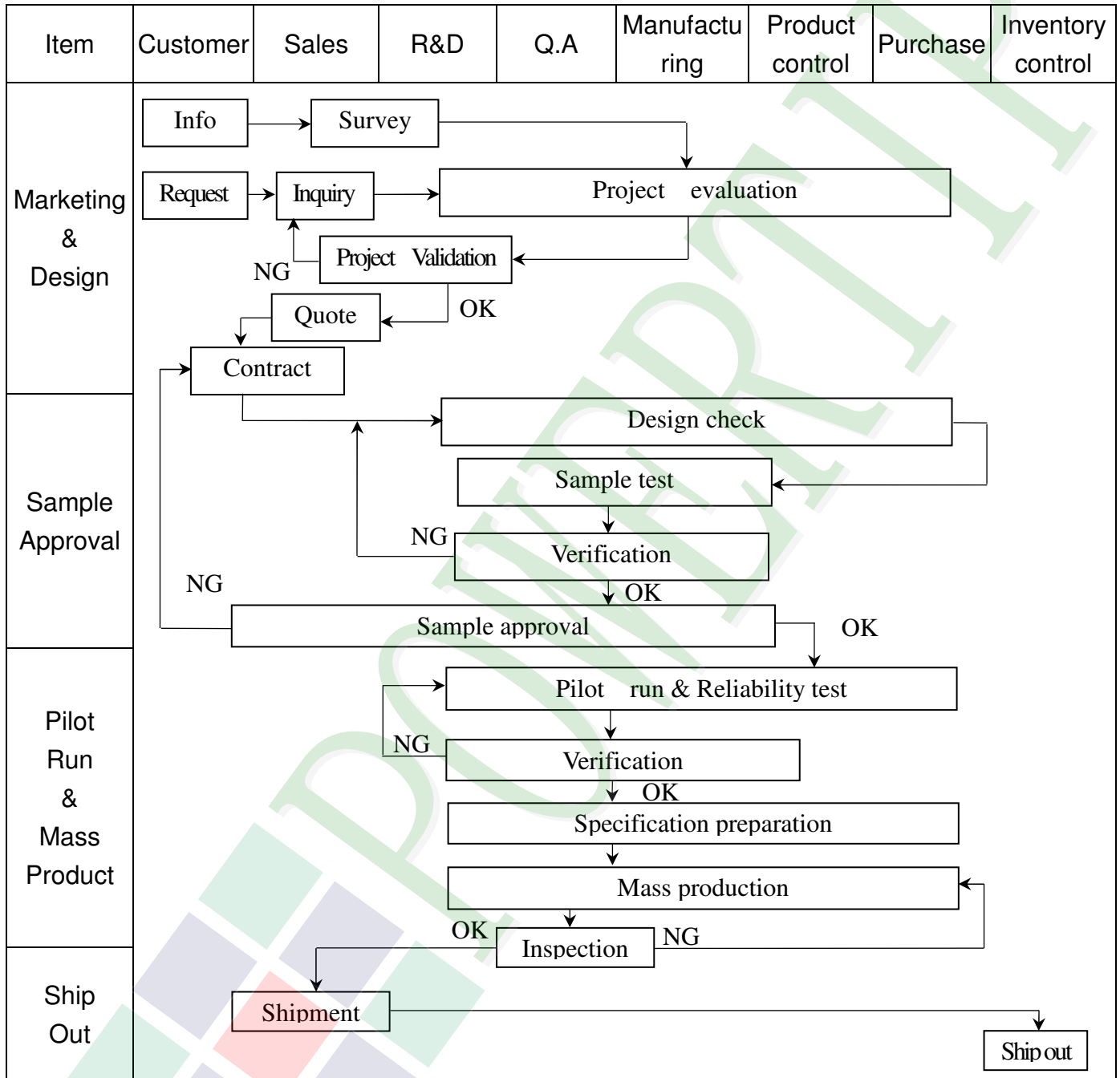

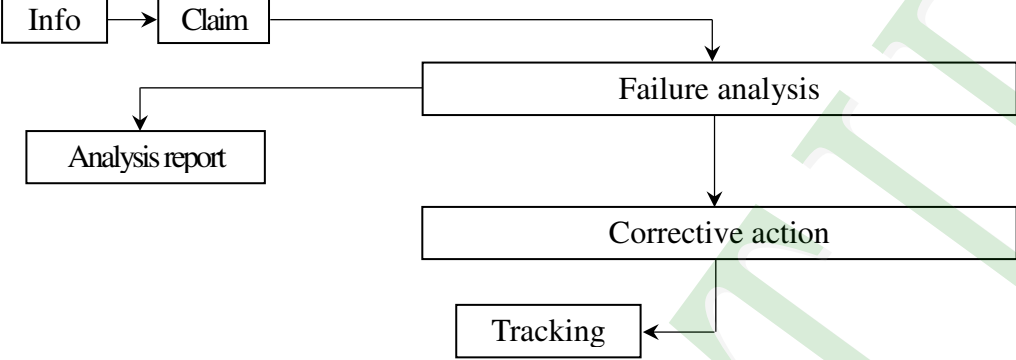
Item	Customer	Sales	R&D	Q.A	Manufacturing	Product control	Purchase	Inventory control
Sales Service	 <pre> graph TD Info[Info] --> Claim[Claim] Claim --> Failure[Failure analysis] Failure --> Report[Analysis report] Failure --> Action[Corrective action] Action --> Tracking[Tracking] </pre>							
Q.A Activity	1. ISO 9001 Maintenance Activities 3. Equipment calibration 5. Standardization Management				2. Process improvement proposal 4. Education And Training Activities			

3.2 Inspection Specification

- ◆Scope : The document shall be applied to TFT-LCD Module for 3.5" ~10" (Ver.B01).
- ◆Inspection Standard : MIL-STD-105E Table Normal Inspection Single Sampling Level II.
- ◆Equipment : Gauge 、MIL-STD 、Powertip Tester 、Sample
- ◆Defect Level : Major Defect AQL : 0.4 ; Minor Defect AQL : 1.5
- ◆OUT Going Defect Level : Sampling.
- ◆Standard of the product appearance test :

a. Manner of appearance test :

- (1). The test best be under 20W×2 fluorescent light , and distance of view must be at 30 cm.
- (2). The test direction is base on about around 45° of vertical line.

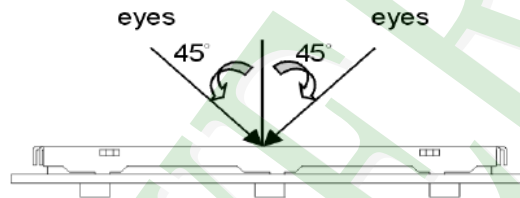

(3). Definition of area.

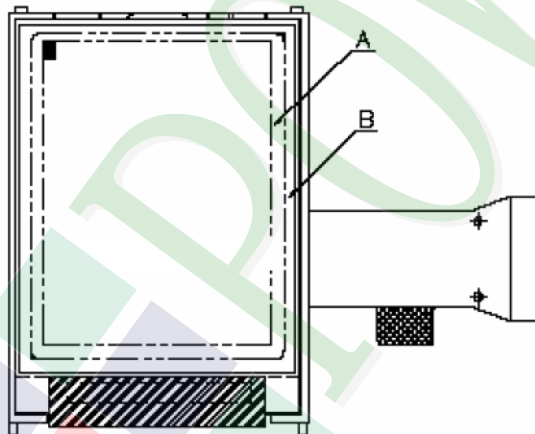

A area : viewing area

B area : Outside of viewing area

(4). Standard of inspection : (Unit : mm)



◆ Specification For TFT-LCD Module 3.5" ~10" :

(Ver.B01)

NO	Item	Criterion	Level										
01	Product condition	1. 1 The part number is inconsistent with work order of production.	Major										
		1. 2 Mixed product types.	Major										
		1. 3 Assembled in inverse direction.	Major										
02	Quantity	2. 1 The quantity is inconsistent with work order of production.	Major										
03	Outline dimension	3. 1 Product dimension and structure must conform to structure diagram.	Major										
04	Electrical Testing	4. 1 Missing line character and icon.	Major										
		4. 2 No function or no display.	Major										
		4. 3 Display malfunction.	Major										
		4. 4 LCD viewing angle defect.	Major										
		4. 5 Current consumption exceeds product specifications.	Major										
05	Dot defect (Bright dot 、 Dark dot) On -display	<table border="1"> <thead> <tr> <th>Item</th> <th>Acceptance (Q'ty)</th> </tr> </thead> <tbody> <tr> <td>Bright Dot</td> <td>≤ 4</td> </tr> <tr> <td>Dark Dot</td> <td>≤ 5</td> </tr> <tr> <td>Joint Dot</td> <td>≤ 3</td> </tr> <tr> <td>Total</td> <td>≤ 7</td> </tr> </tbody> </table>	Item	Acceptance (Q'ty)	Bright Dot	≤ 4	Dark Dot	≤ 5	Joint Dot	≤ 3	Total	≤ 7	Minor
		Item	Acceptance (Q'ty)										
		Bright Dot	≤ 4										
		Dark Dot	≤ 5										
		Joint Dot	≤ 3										
Total	≤ 7												
5. 1 Inspection pattern : full white , full black , Red , Green and blue screens.													
5. 2 It is defined as dot defect if defect area $> 1/2$ dot.													
5. 3 The distance between two dot defect ≥ 5 mm.													



◆ Specification For TFT-LCD Module 3.5" ~10" :

(Ver.B01)

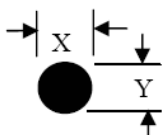
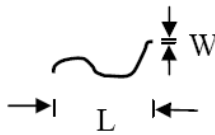
NO	Item	Criterion	Level																																								
06	<p>Black or white dot、scratch、contamination</p> <p>Round type</p>  <p>$\Phi = (x + y) / 2$</p> <p>Line type</p> 	<p>6.1 Round type (Non-display or display) :</p> <table border="1"> <thead> <tr> <th rowspan="2">Dimension (diameter : Φ)</th> <th colspan="2">Acceptance (Q'ty)</th> </tr> <tr> <th>A area</th> <th>B area</th> </tr> </thead> <tbody> <tr> <td>$\Phi \leq 0.25$</td> <td colspan="2">Ignore</td> </tr> <tr> <td>$0.25 < \Phi \leq 0.50$</td> <td>5</td> <td rowspan="3">Ignore</td> </tr> <tr> <td>$\Phi > 0.50$</td> <td>0</td> </tr> <tr> <td>Total</td> <td>5</td> </tr> </tbody> </table> <p>6.2 Line type(Non-display or display) :</p> <table border="1"> <thead> <tr> <th rowspan="2">Length (L)</th> <th rowspan="2">Width (W)</th> <th colspan="2">Acceptance (Q'ty)</th> </tr> <tr> <th>A area</th> <th>B area</th> </tr> </thead> <tbody> <tr> <td>--</td> <td>$W \leq 0.03$</td> <td colspan="2">Ignore</td> </tr> <tr> <td>$L \leq 10.0$</td> <td>$0.03 < W \leq 0.05$</td> <td>4</td> <td rowspan="3">Ignore</td> </tr> <tr> <td>$L \leq 5.0$</td> <td>$0.05 < W \leq 0.10$</td> <td>2</td> </tr> <tr> <td>--</td> <td>$W > 0.10$</td> <td colspan="2">As round type</td> </tr> <tr> <td colspan="2">Total</td> <td>5</td> <td></td> </tr> </tbody> </table>	Dimension (diameter : Φ)	Acceptance (Q'ty)		A area	B area	$\Phi \leq 0.25$	Ignore		$0.25 < \Phi \leq 0.50$	5	Ignore	$\Phi > 0.50$	0	Total	5	Length (L)	Width (W)	Acceptance (Q'ty)		A area	B area	--	$W \leq 0.03$	Ignore		$L \leq 10.0$	$0.03 < W \leq 0.05$	4	Ignore	$L \leq 5.0$	$0.05 < W \leq 0.10$	2	--	$W > 0.10$	As round type		Total		5		Minor
Dimension (diameter : Φ)	Acceptance (Q'ty)																																										
	A area	B area																																									
$\Phi \leq 0.25$	Ignore																																										
$0.25 < \Phi \leq 0.50$	5	Ignore																																									
$\Phi > 0.50$	0																																										
Total	5																																										
Length (L)	Width (W)	Acceptance (Q'ty)																																									
		A area	B area																																								
--	$W \leq 0.03$	Ignore																																									
$L \leq 10.0$	$0.03 < W \leq 0.05$	4	Ignore																																								
$L \leq 5.0$	$0.05 < W \leq 0.10$	2																																									
--	$W > 0.10$	As round type																																									
Total		5																																									
07	<p>Polarizer Bubble</p>	<table border="1"> <thead> <tr> <th rowspan="2">Dimension (diameter : Φ)</th> <th colspan="2">Acceptance (Q'ty)</th> </tr> <tr> <th>A area</th> <th>B area</th> </tr> </thead> <tbody> <tr> <td>$\Phi \leq 0.25$</td> <td colspan="2">Ignore</td> </tr> <tr> <td>$0.25 < \Phi \leq 0.50$</td> <td>4</td> <td rowspan="3">Ignore</td> </tr> <tr> <td>$0.50 < \Phi \leq 0.80$</td> <td>1</td> </tr> <tr> <td>$\Phi > 0.80$</td> <td>0</td> </tr> <tr> <td>Total</td> <td>5</td> <td></td> </tr> </tbody> </table>	Dimension (diameter : Φ)	Acceptance (Q'ty)		A area	B area	$\Phi \leq 0.25$	Ignore		$0.25 < \Phi \leq 0.50$	4	Ignore	$0.50 < \Phi \leq 0.80$	1	$\Phi > 0.80$	0	Total	5		Minor																						
Dimension (diameter : Φ)	Acceptance (Q'ty)																																										
	A area	B area																																									
$\Phi \leq 0.25$	Ignore																																										
$0.25 < \Phi \leq 0.50$	4	Ignore																																									
$0.50 < \Phi \leq 0.80$	1																																										
$\Phi > 0.80$	0																																										
Total	5																																										

◆ Specification For TFT-LCD Module 3.5" ~10" :

(Ver.B01)

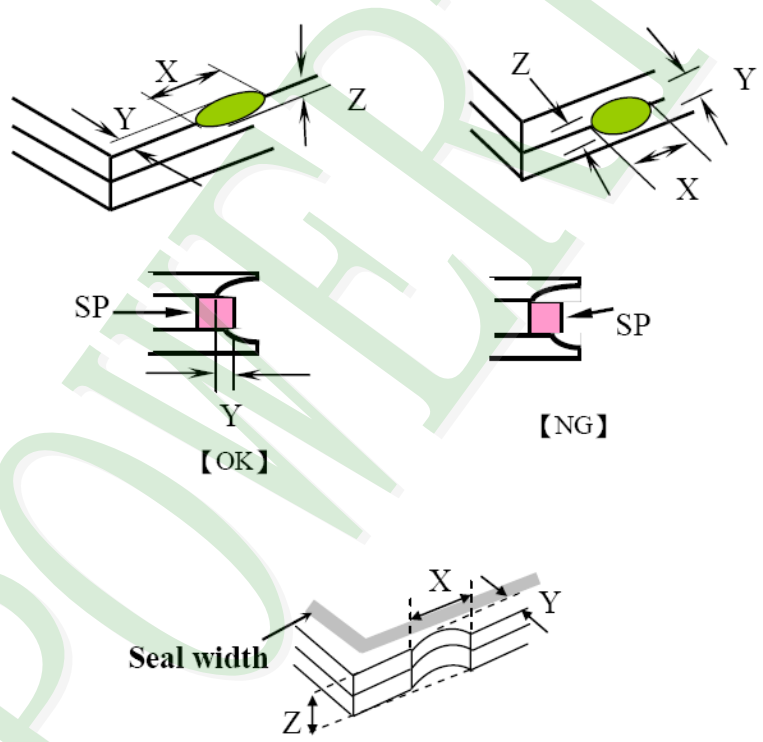
NO	Item	Criterion	Level						
08	The crack of glass	<p>Symbols :</p> <p>X : The length of crack Z : The thickness of crack t : The thickness of glass</p> <p>Y : The width of crack. W : terminal length a : LCD side length</p>	Minor						
		<p>8.1 General glass chip :</p> <p>8.1.1 Chip on panel surface and crack between panels:</p>  <table border="1" data-bbox="542 1545 1340 1836"> <thead> <tr> <th>X</th> <th>Y</th> <th>Z</th> </tr> </thead> <tbody> <tr> <td>$\leq a$</td> <td>Crack can't enter viewing area</td> <td>$\leq 1/2 t$</td> </tr> <tr> <td>$\leq a$</td> <td>Crack can't exceed the half of SP width.</td> <td>$1/2 t < Z \leq 2 t$</td> </tr> </tbody> </table>		X	Y	Z	$\leq a$	Crack can't enter viewing area	$\leq 1/2 t$
X	Y	Z							
$\leq a$	Crack can't enter viewing area	$\leq 1/2 t$							
$\leq a$	Crack can't exceed the half of SP width.	$1/2 t < Z \leq 2 t$							

◆ Specification For TFT-LCD Module 3.5" ~10" :

(Ver.B01)

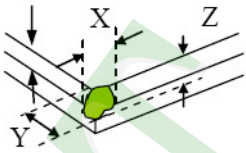
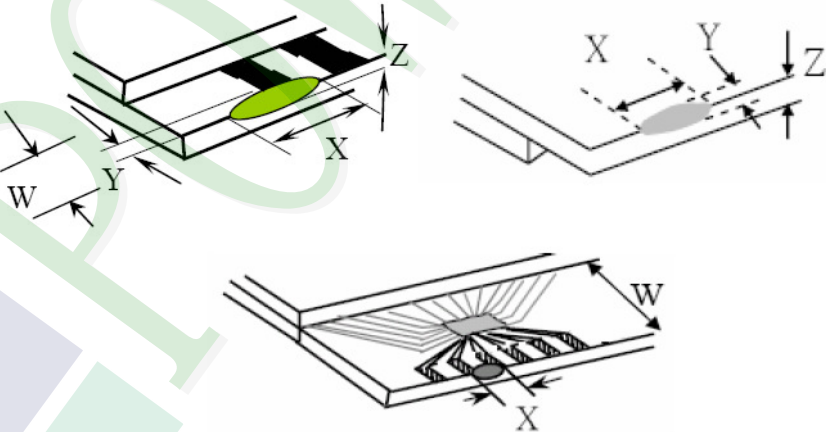
NO	Item	Criterion	Level												
08	The crack of glass	<p>Symbols :</p> <p>X : The length of crack Z : The thickness of crack t : The thickness of glass</p> <p>Y : The width of crack. W : terminal length a : LCD side length</p> <hr/> <p>8.1.2 Corner crack :</p>  <table border="1" data-bbox="525 757 1332 1048"> <thead> <tr> <th>X</th> <th>Y</th> <th>Z</th> </tr> </thead> <tbody> <tr> <td>$\leq 1/5 a$</td> <td>Crack can't enter viewing area</td> <td>$Z \leq 1/2 t$</td> </tr> <tr> <td>$\leq 1/5 a$</td> <td>Crack can't exceed the half of SP width.</td> <td>$1/2 t < Z \leq 2 t$</td> </tr> </tbody> </table>	X	Y	Z	$\leq 1/5 a$	Crack can't enter viewing area	$Z \leq 1/2 t$	$\leq 1/5 a$	Crack can't exceed the half of SP width.	$1/2 t < Z \leq 2 t$				
		X	Y	Z											
$\leq 1/5 a$	Crack can't enter viewing area	$Z \leq 1/2 t$													
$\leq 1/5 a$	Crack can't exceed the half of SP width.	$1/2 t < Z \leq 2 t$													
		<p>8.2 Protrusion over terminal :</p> <p>8.2.1 Chip on electrode pad :</p>  <table border="1" data-bbox="563 1675 1342 1848"> <thead> <tr> <th></th> <th>X</th> <th>Y</th> <th>Z</th> </tr> </thead> <tbody> <tr> <td>Front</td> <td>$\leq a$</td> <td>$\leq 1/2 W$</td> <td>$\leq t$</td> </tr> <tr> <td>Back</td> <td>$\leq a$</td> <td>$\leq W$</td> <td>$\leq 1/2 t$</td> </tr> </tbody> </table>		X	Y	Z	Front	$\leq a$	$\leq 1/2 W$	$\leq t$	Back	$\leq a$	$\leq W$	$\leq 1/2 t$	Minor
	X	Y	Z												
Front	$\leq a$	$\leq 1/2 W$	$\leq t$												
Back	$\leq a$	$\leq W$	$\leq 1/2 t$												

◆ Specification For TFT-LCD Module 3.5" ~10" :

(Ver.B01)

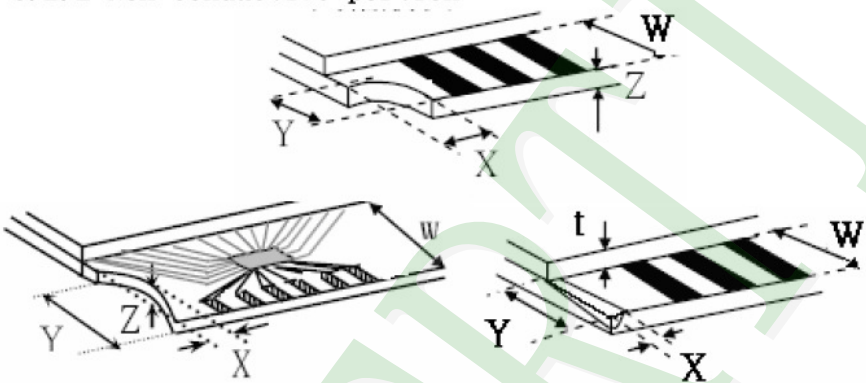
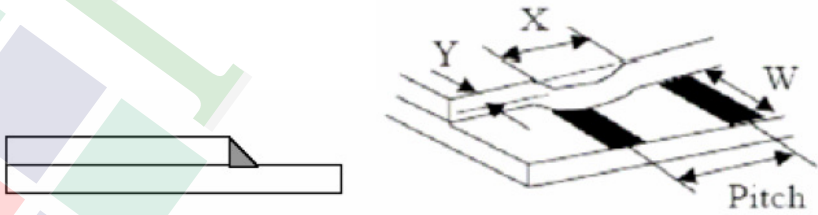
NO	Item	Criterion	Level						
08	The crack of glass	<p>Symbols :</p> <p>X : The length of crack Y : The width of crack. Z : The thickness of crack W : terminal length t : The thickness of glass a : LCD side length</p> <hr/> <p>8.2.2 Non-conductive portion :</p>  <table border="1" data-bbox="630 963 1260 1120"> <thead> <tr> <th>X</th> <th>Y</th> <th>Z</th> </tr> </thead> <tbody> <tr> <td>$\leq 1/3 a$</td> <td>$\leq W$</td> <td>$\leq t$</td> </tr> </tbody> </table> <p>⊙ If the chipped area touches the ITO terminal, over 2/3 of the ITO must remain and be inspected according to electrode terminal specifications.</p>	X	Y	Z	$\leq 1/3 a$	$\leq W$	$\leq t$	Minor
		X	Y	Z					
$\leq 1/3 a$	$\leq W$	$\leq t$							
<p>8.2.3 Glass remain :</p>  <table border="1" data-bbox="550 1736 1244 1881"> <thead> <tr> <th>X</th> <th>Y</th> <th>Z</th> </tr> </thead> <tbody> <tr> <td>$\leq a$</td> <td>$\leq 1/3 W$</td> <td>$\leq t$</td> </tr> </tbody> </table>	X	Y	Z	$\leq a$	$\leq 1/3 W$	$\leq t$			
X	Y	Z							
$\leq a$	$\leq 1/3 W$	$\leq t$							



◆Specification For TFT-LCD Module 3.5" ~10" :

(Ver.B01)

NO	Item	Criterion	Level
09	Backlight elements	9. 1 Backlight can't work normally.	Major
		9. 2 Backlight doesn't light or color is wrong.	Major
		9. 3 Illumination source flickers when lit.	Major
10	General appearance	10. 1 Pin type 、 quantity 、 dimension must match type in structure diagram.	Major
		10. 2 No short circuits in components on PCB or FPC .	Major
		10. 3 Parts on PCB or FPC must be the same as on the production characteristic chart .There should be no wrong parts , missing parts or excess parts.	Major
		10. 4 Product packaging must the same as specified on packaging specification sheet.	Minor
		10. 5 The folding and peeled off in polarizer are not acceptable.	Minor
		10. 6 The PCB or FPC between B/L assembled distance(PCB or FPC) is ≤ 1.5 mm.	Minor

4. RELIABILITY TEST

4.1 Reliability Test Condition

(Ver.B01)

NO.	TEST ITEM	TEST CONDITION										
1	High Temperature Storage Test	Keep in +80 ±2°C 96 hrs Surrounding temperature, then storage at normal condition 4hrs.										
2	Low Temperature Storage Test	Keep in -30 ±2°C 96 hrs Surrounding temperature, then storage at normal condition 4hrs.										
3	High Temperature / High Humidity Storage Test	Keep in +60 °C / 90% R.H duration for 96 hrs Surrounding temperature, then storage at normal condition 4hrs. (Excluding the polarizer)										
4	Temperature Cycling Storage Test	<p style="text-align: center;"> $-30^{\circ}\text{C} \rightarrow +25^{\circ}\text{C} \rightarrow +80^{\circ}\text{C} \rightarrow +25^{\circ}\text{C}$ (30mins) (5mins) (30mins) (5mins) $\leftarrow \hspace{15em} \rightarrow$ 10 Cycle </p> Surrounding temperature, then storage at normal condition 4hrs.										
5	ESD Test	Air Discharge: Apply 2 KV with 5 times Discharge for each polarity +/-										
		Contact Discharge: Apply 250 V with 5 times discharge for each polarity +/-										
		1. Temperature ambience : 15°C ~ 35°C 2. Humidity relative : 30% ~ 60% 3. Energy Storage Capacitance(Cs+Cd) : 150pF±10% 4. Discharge Resistance(Rd) : 330Ω±10% 5. Discharge, mode of operation : Single Discharge (time between successive discharges at least 1 sec) (Tolerance if the output voltage indication : ±5%)										
6	Vibration Test (Packaged)	1. Sine wave 10~55 Hz frequency (1 min/sweep) 2. The amplitude of vibration : 1.5 mm 3. Each direction (X、Y、Z) duration for 2 Hrs										
7	Drop Test (Packaged)	<table border="1" style="width: 100%; text-align: center;"> <thead> <tr> <th>Packing Weight (Kg)</th> <th>Drop Height (cm)</th> </tr> </thead> <tbody> <tr> <td>0 ~ 45.4</td> <td>122</td> </tr> <tr> <td>45.4 ~ 90.8</td> <td>76</td> </tr> <tr> <td>90.8 ~ 454</td> <td>61</td> </tr> <tr> <td>Over 454</td> <td>46</td> </tr> </tbody> </table>	Packing Weight (Kg)	Drop Height (cm)	0 ~ 45.4	122	45.4 ~ 90.8	76	90.8 ~ 454	61	Over 454	46
		Packing Weight (Kg)	Drop Height (cm)									
0 ~ 45.4	122											
45.4 ~ 90.8	76											
90.8 ~ 454	61											
Over 454	46											
		Drop Direction : ※1 corner / 3 edges / 6 sides each 1time										

5. PRECAUTION RELATING PRODUCT HANDLING

5.1 SAFETY

- 5.1.1 If the LCD panel breaks , be careful not to get the liquid crystal to touch your skin.
- 5.1.2 If the liquid crystal touches your skin or clothes , please wash it off immediately by using soap and water.

5.2 HANDLING

- 5.2.1 Avoid any strong mechanical shock which can break the glass.
- 5.2.2 Avoid static electricity which can damage the CMOS LSI—When working with the module , be sure to ground your body and any electrical equipment you may be using.
- 5.2.3 Do not remove the panel or frame from the module.
- 5.2.4 The polarizing plate of the display is very fragile. So , please handle it very carefully ,do not touch , push or rub the exposed polarizing with anything harder than an HB pencil lead (glass , tweezers , etc.)
- 5.2.5 Do not wipe the polarizing plate with a dry cloth , as it may easily scratch the surface of plate.
- 5.2.6 Do not touch the display area with bare hands , this will stain the display area.
- 5.2.7 Do not use ketonics solvent & aromatic solvent. Use with a soft cloth soaked with a cleaning naphtha solvent.
- 5.2.8 To control temperature and time of soldering is $320\pm 10^{\circ}\text{C}$ and 3-5 sec.
- 5.2.9 To avoid liquid (include organic solvent) stained on LCM .

5.3 STORAGE

- 5.3.1 Store the panel or module in a dark place where the temperature is $25^{\circ}\text{C} \pm 5^{\circ}\text{C}$ and the humidity is below 65% RH.
- 5.3.2 Do not place the module near organics solvents or corrosive gases.
- 5.3.3 Do not crush , shake , or jolt the module.

5.4 TERMS OF WARRANTY

- 5.4.1 Applicable warrant period
The period is within thirteen months since the date of shipping out under normal using and storage conditions.
- 5.4.2 Unaccepted responsibility
This product has been manufactured to your company's specification as a part for use in your company's general electronic products. It is guaranteed to perform according to delivery specifications. For any other use apart from general electronic equipment , we cannot take responsibility if the product is used in nuclear power control equipment , aerospace equipment , fire and security systems or any other applications in which there is a direct risk to human life and where extremely high levels of reliability are required.

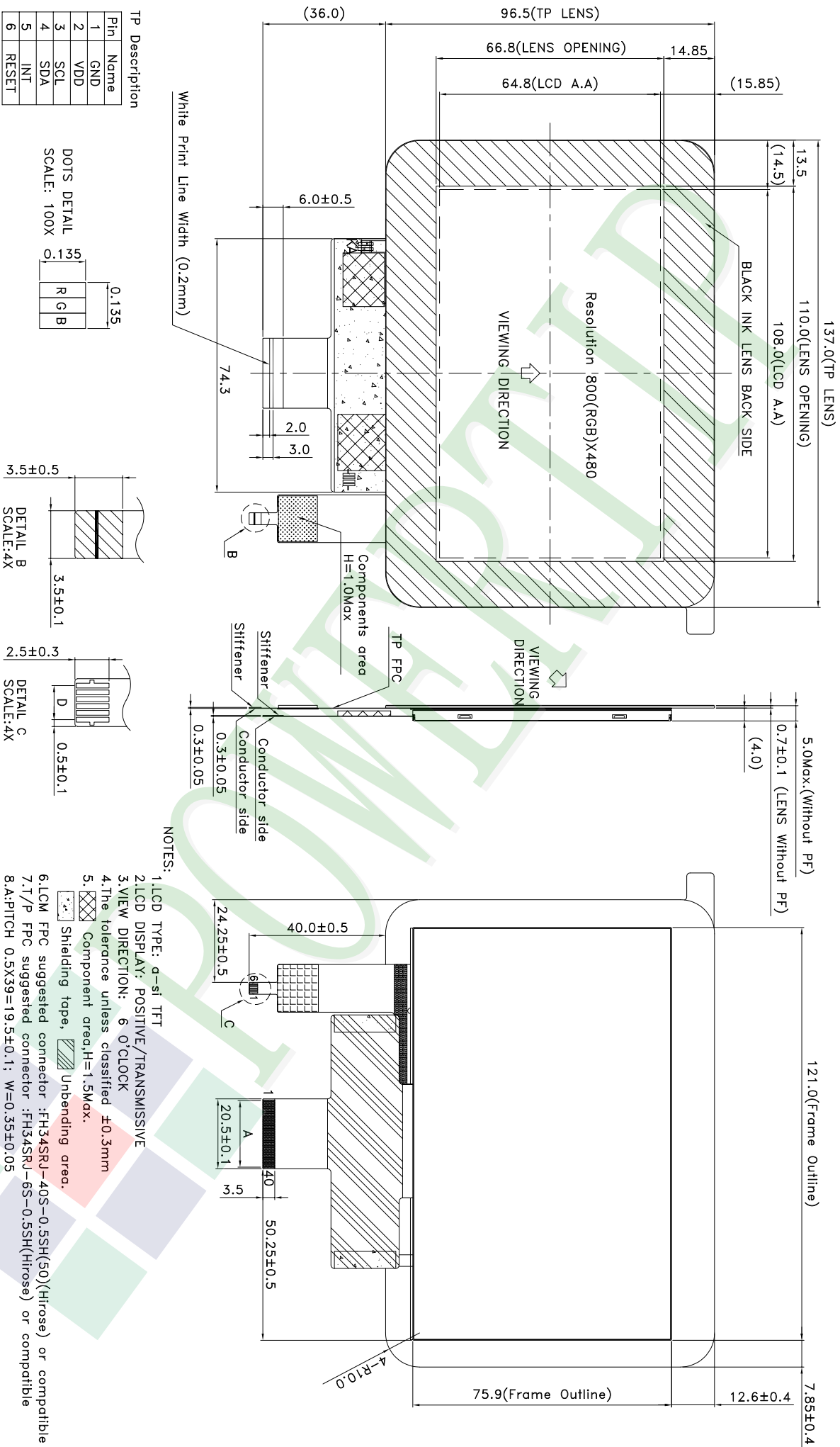

White Print Line Width (0.2mm)

TP Description

Pin	Name
1	GND
2	VDD
3	SCL
4	SDA
5	INT
6	RESET

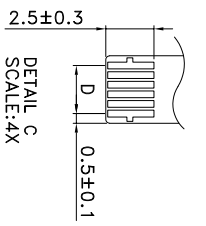
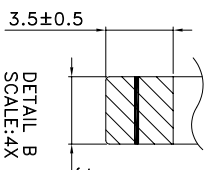
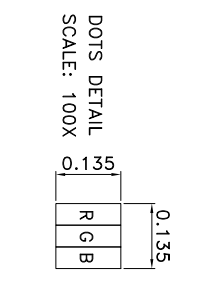

NOTES:

- LCD TYPE: a-si TFT
- LCD DISPLAY: POSITIVE/TRANSMISSIVE
- VIEW DIRECTION: 6 O'CLOCK
- The tolerance unless classified ±0.3mm
- Component area, H=1.5Max.
- Shielding tape, ▨ Unbending area.
- LCM FPC suggested connector: FH34SRJ-40S-0.5SH(50)(Hirose) or compatible
- T/P FPC suggested connector: FH34SRJ-6S-0.5SH(Hirose) or compatible
- A:PITCH 0.5X39=19.5±0.1; W=0.35±0.05
- D:PITCH 0.5X5=2.5±0.1; W=0.35±0.05

PART NO:
PH800480T024-1CC01

久正光电股份有限公司
POWER TIP TECHNOLOGY CORPORATION

DRAWING NAME: LMD-PH800480T024-1CC01	Design	Peggy Ho	Surface	7.85±0.4	Precision Level
TITLE: LCD MODULE DRAWING	Check	Tina Chen	Material	12.6±0.4	-
REV: NEW DRAWING	Approve	Linda Lee	Thickness	75.9(Frame Outline)	-
REV BY: REV BY	REVISER: Peggy	DATE: 2016/01/11	Quantity	121.0(Frame Outline)	-
			Page: 1/1	5.0Max.(Without PF)	-
				0.7±0.1 (LENS Without PF)	-
				(4.0)	-
				110.0(LENS OPENING)	-
				137.0(TP LENS)	-

Approve	Check	Contact
Linda	Tina	Peggy

1. 包裝材料規格表 (Packaging Material) : (per carton)

No.	Item	Model	Dimensions (mm)	1Pcs Weight	Quantity	Total Weight
1	成品 (LCM)	PH800480T024-ICC01	137.0 X 96.5	0.09075	144	13.068
2	多層薄膜(1)POF	OTFILM0BA03ABA	19"X350X0.015	—	6	—
3	TRAY 盤 (2)Tray	TY00000000308	352 X 260 X 12.8	0.0965	42	4.053
4	舒美墊(3) EPE	FOAM000000047	350 X 255 X 5	0.011	6	0.066
5	內盒(4)Product Box	BX36627063ABBA	383 X 270 X 66	0.182	6	1.092
6	保利龍板(5)Polylon board	OTPLB00PL08ABA	550 X 393 X 20	0.0284	2	0.0568
7	外紙箱(6)Carton	BX57041027CCBA	570 X 410 X 265	1.0	1	1.0
8						
9						

2. 一整箱總重量 (Total LCD Weight in carton) : 19.34 Kg±10%

3. 單箱數量規格表 (Packaging Specifications and Quantity) :

(1) LCM quantity per box : no per tray	4	x no of tray	6	=	24
(2) Total LCM quantity in carton : quantity per box	24	x no of boxes	6	=	144

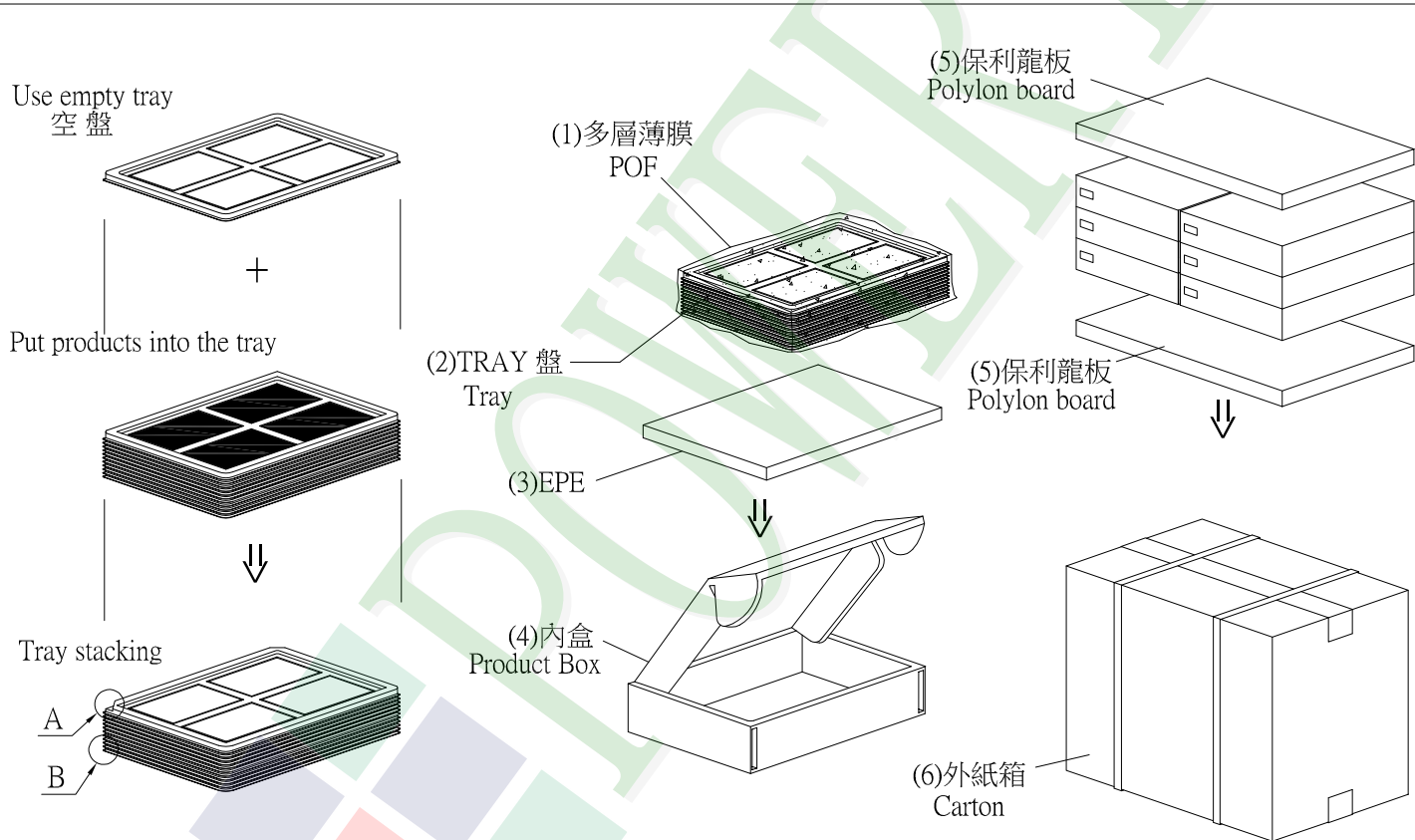

特 記 事 項 (REMARK)

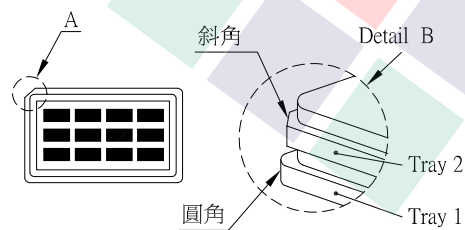

4. TRAY盤相疊時,需旋轉180度,請詳見B視圖
Rotate tray 180 degrees and place on top of stack.
Check the tray stack using Fig. B.