



SPECIFICATIONS

CUSTOMER	:	_____
SAMPLE CODE	:	SH800480T024-IDB01
MASS PRODUCTION CODE	:	PH800480T024-IDB01
SAMPLE VERSION	:	01
SPECIFICATIONS EDITION	:	005
DRAWING NO. (Ver.)	:	LMD-PH800480T024-IDB01(Ver.001)
PACKAGING NO. (Ver.)	:	PKG-PH800480T024-IDB01(Ver.002)

Customer Approved

Date:

Approved	Checked	Designer
廖志豪 Rex Liao	張慶源 Yuan Chang	陳宗淇 Howard Chen

- Preliminary specification for design input
- Specification for sample approval

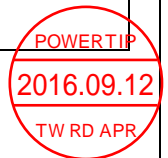

POWERTIP TECH. CORP.

Headquarters: No.8, 6 th Road, Taichung Industrial Park, Taichung, Taiwan 台中市 407 工業區六路 8 號	TEL: 886-4-2355-8168 FAX: 886-4-2355-8166	E-mail: sales@powertip.com.tw Http://www.powertip.com.tw
---	--	--

History of Version

Date <small>(mm / dd / yyyy)</small>	Ver.	Edi.	Description	Page	Design by
01/12/2016	01	001	New Drawing.	-	Howard
02/26/2016	01	002	Modify Interface Pin Description. Add Touch Panel Pin Define.	16	Howard
04/07/2016	01	003	New Sample	-	Howard
07/29/2016	01	004	Modify Backlight Maximum Ratings	9	Howard
09/10/2016	01	005	Modify Packing Specification	Appendix	Howard

Total: 30 Pages

Contents

1. SPECIFICATIONS

- 1.1 Features
- 1.2 Mechanical Specifications
- 1.3 Absolute Maximum Ratings
- 1.4 DC Electrical Characteristics
- 1.5 Optical Characteristics
- 1.6 Backlight Characteristics
- 1.7 Touch Panel Specification

2. MODULE STRUCTURE

- 2.1 Counter Drawing
- 2.2 Interface Pin Description
- 2.3 Timing Characteristics

3. QUALITY ASSURANCE SYSTEM

- 3.1 Quality Assurance Flow Chart
- 3.2 Inspection Specification

4. RELIABILITY TEST

- 4.1 Reliability Test Condition

5. PRECAUTION RELATING PRODUCT HANDLING

- 5.1 Safety
- 5.2 Handling
- 5.3 Storage
- 5.4 Terms of Warranty

Appendix : 1.LCM Drawing

2. Packing Specification

Note : For detailed information please refer to IC data sheet :

Primacy(TFT LCD): ILITEK--- ILI6122M-9G / ILI5960-9G

(Or compatible IC)

1. SPECIFICATIONS

1.1 Features

Item	Standard Value
Display Type	800 * 3 (RGB) * 480 Dots
LCD Type	a-Si TFT , Normally white, Transmissive type
Screen size(inch)	5.0 inch
Viewing Direction	6 O'clock
Color configuration	RGB-Strip
Backlight Type	LED B/L
Interface	Digital 24-bits RGB
Other(controller/driver IC)	Source IC : ILI6122M-9G / Gate IC: ILI5960-9G (Or Compatible IC)
ROHS	THIS PRODUCT CONFORMS THE ROHS OF PTC Detail information please refer website : http://www.powertip.com.tw/news.php?area_id_view=1085560481/

1.2 Mechanical Specifications

Item	Standard Value	Unit
Outline Dimension	121.0(W) x 75.9 (L) x 4.2(H)	mm

LCD panel

Item	Standard Value	Unit
Viewing Area	109.0 (W) * 65.8 (L)	mm
Active Area	108.0 (W) x 64.8 (L)	mm
Pixel Size	0.135 (W) * 0.135 (H)	mm

Touch panel

Item	Standard Value	Unit
Viewing Area	110.4 (W) * 67.4 (L)	mm
Active Area	109.0 (W) * 65.8 (L)	mm

Note : For detailed information please refer to LCM drawing

1.3 Absolute Maximum Ratings

Module

Item	Symbol	Condition	Min.	Max.	Unit
System Power Supply Voltage	VDD	GND=0	-0.3	4.5	V
Operating Temperature	T _{OP}	-	-20	70	°C
Storage Temperature	T _{ST}	-	-30	80	°C
Storage Humidity	H _D	T _a ≦ 60 °C	10	90	%RH

1.4 DC Electrical Characteristics

Module

GND = 0V, T_a = 25 °C

Item	Symbol	Condition	Min.	Typ.	Max.	Unit
Power Supply Voltage	VDD	-	3.0	3.3	3.6	V
Input H/L Level Voltage	V _{IH}	-	0.7VDD	-	VDD	V
	V _{IL}	-	GND	-	0.3VDD	V
Output H/L Level Voltage	V _{OH}	-	VDD-0.4	-	VDD	V
	V _{OL}	-	GND	-	GND+0.4	V
Supply Current	I _{DD}	VDD= 3.3 V Pattern=Photo	-	100	-	mA
		VDD= 3.3 V Pattern=R *1	-	120	180	mA

Note1:Maximum current display

1.5 Optical Characteristics

TFT LCD Module

VDD= 3.3 V, Ta=25°C

Item		Symbol	Condition	Min.	Typ.	Max.	unit	-
Response time	Tr+Tf	25°C	-	-	35	55	ms	-
Viewing angle	Top	$\theta Y+$	CR \geq 10		60	-	Deg.	Note 4
	Bottom	$\theta Y-$			60	-		
	Left	$\theta X-$			60	-		
	Right	$\theta X+$			60	-		
Contrast ratio		CR		500	600	-	-	Note 3
Color of CIE Coordinate (With B/L & T/P)	White	X	Ta = 25°C $\theta X, \theta Y = 0^\circ$	0.26	0.31	0.36	-	Note1
		Y		0.29	0.34	0.39		
	Red	X		0.50	0.55	0.60		
		Y		0.27	0.32	0.37		
	Green	X		0.29	0.34	0.39		
		Y		0.54	0.59	0.64		
	Blue	X		0.09	0.14	0.19		
		Y		0.03	0.08	0.13		
Average Brightness Pattern=white display (With LCD & T/P)*1		IV	IF= 120 mA	600	700	-	cd/m ²	Note1
Uniformity (With LCD & T/P)*2		ΔB	IF= 120 mA	70	-	-	%	Note1

Note 1:

*1 : $\Delta B = B(\text{min}) / B(\text{max}) * 100\%$

*2 : Measurement Condition for Optical Characteristics:

- a : Environment: $25^{\circ}\text{C} \pm 5^{\circ}\text{C}$ / $60 \pm 20\% \text{R.H}$, no wind , dark room below 10 Lux at typical lamp current and typical operating frequency.
- b : Measurement Distance: 500 ± 50 mm , ($\theta = 0^{\circ}$)
- c : Equipment: TOPCON BM-7 fast , (field 1°) , after 10 minutes operation.
- d : The uncertainty of the C.I.E coordinate measurement ± 0.01 , Average Brightness $\pm 4\%$

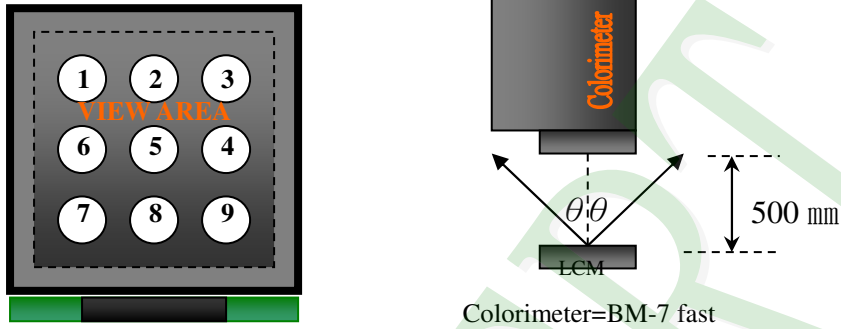

To be measured at the center area of panel with a viewing cone of 1° by Topcon luminance meter BM-7, after 10 minutes operation (module)

Note2: Definition of response time:

The output signals of photo detector are measured when the input signals are changed from "black" to "white"(falling time) and from "white" to "black"(rising time), respectively. The response time is defined as the time interval between the 10% and 90% of Amplitudes.

Refer to figure as below:

Normally White



Normally Black

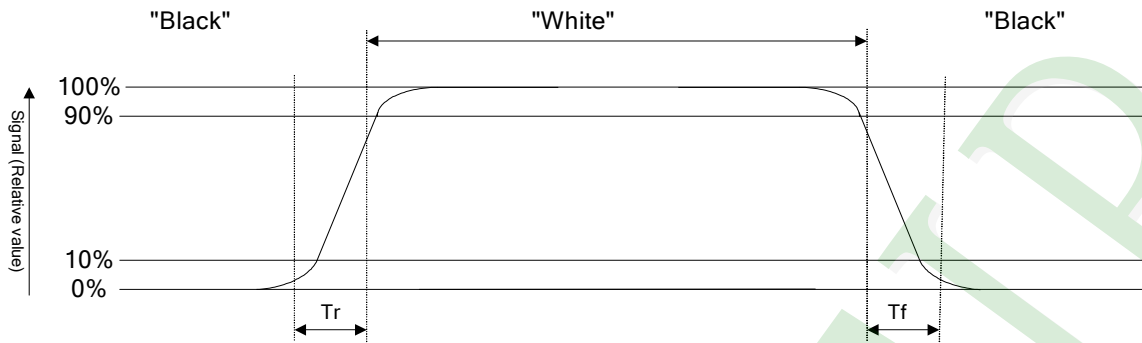

Note3: Definition of contrast ratio:

Contrast ratio is calculated with the following formula

$$\text{Contrast ratio (CR)} = \frac{\text{Photo detector output when LCD is at "White" state}}{\text{Photo detector output when LCD is at "Black" state}}$$

Note4: Definition of viewing angle:

Refer to figure as below:

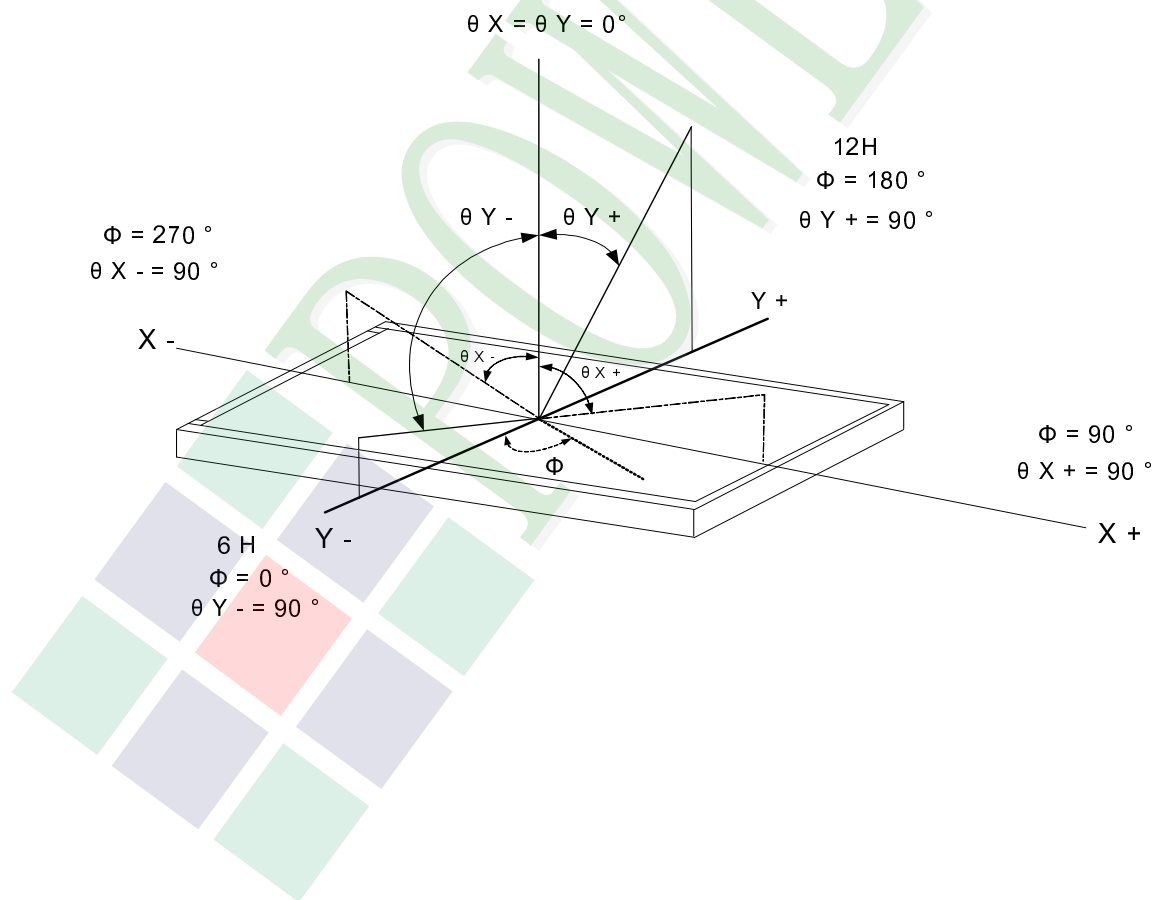

1.6 Backlight Characteristics

Maximum Ratings

Item	Symbol	Conditions	Min.	Max.	Unit
LED Forward Current	IF	Ta =25°C	-	210	mA
LED Reverse Voltage	IR	Ta =25°C	-	10	V
Power Dissipation	PD	Ta =25°C	-	4284	mW

Electrical / Optical Characteristics

Item	Symbol	Conditions	Min.	Typ.	Max.	Unit
Forward Voltage	VF	IF=120mA	16.8	18.6	-	V
Average Brightness (Without LCD)	IV		20500	23500	-	cd/m ²
CIE Color Coordinate (Without LCD)	X		0.25	0.28	0.31	-
	Y		0.25	0.28	0.31	
Color		White				

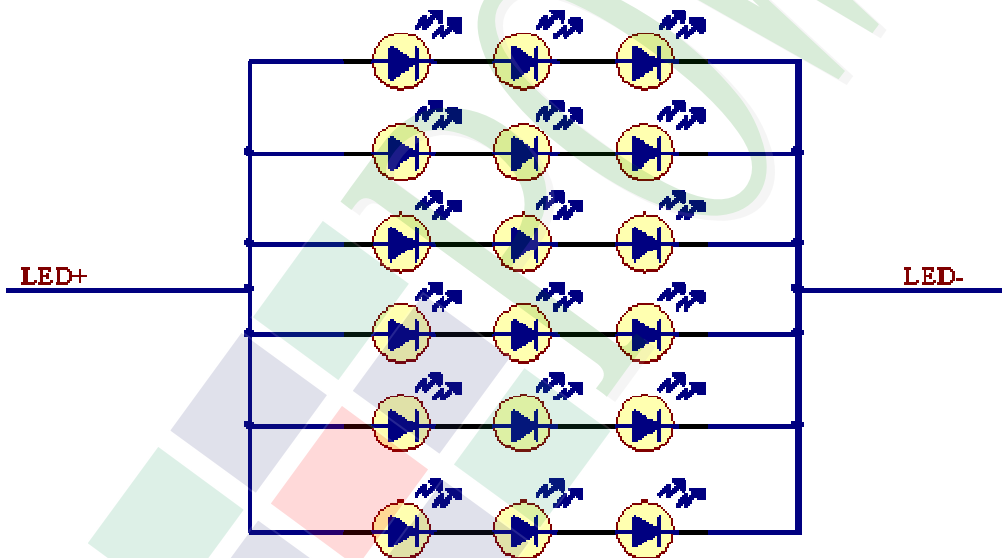

Other Description

Item	Conditions	Description
Life Time	Ta =25°C IF= 120mA	30,000 hrs

1.7 Touch Panel Specification

1.7.1 Optical Characteristics

Item	Specification
1. Transparency	78% Min

1.7.2 Mechanical Characteristic

Item	Specification
1. Input Method	Finger or stylus pen
2. Hardness of surface	3H -pressure 500g of ,45deg.
3. Activation Force	120gf less individual point with stylus pen(R0.8) Activation force guarantee area:3.0mm inside of Active Area.
4. Linearity Force	120gf less input with stylus pen(R0.8) Activation force guarantee area:3.0mm inside of Active Area.

1.7.3 Electrical Characteristics

Item	Specification
1. Rated Voltage	DC 5V(DC 7V Max)
2. Resistance Between Terminals.	Direction X (Film side): 200Ω~ 1050Ω
	Direction Y (Glass side): 100Ω~ 900Ω
3. Insulation Resistance	20 MΩ or more (DC 25V 1min)
4. Linearity	±1.5%. Linearity(%)= $\Delta V / (EV - SV) * 100$. ΔV : The difference between the ideal voltage and measured voltage on the each measuring line. SV: Voltage of starting Points. EV: Voltage of Ending Points. (Test condition refers to 1.7.2 item4)
5. Bouncing	<10ms (Tip R 3.75mm, hardness 10°~20°, silicon rubber ,500gf operation : 40 mm/sec)

1.7.4 Reliability Characteristic

NO	Test Item	Test Condition	Test Result
1	Hitting Durability	1,000,000times min.(R 8 mm Silicon Rubber Hardness 60°250gf 3times/sec).	Follow 1.7.3 item2 and item4.
2	Pen Sliding Durability	100,000 times min (TipR0.8mm).	Follow 1.7.3 item2 and item4.
3	Impact Resistance	φ9mm steel ball is dropped on the surface from 30 cm height at 1 time.	No Crack
4	Flexible pattern Bending Resistance	Bending 3 times by bending radius R1.0 mm	Follow 1.7.3 item2.

1.7.5 Touch Panel Design/Handing Guide

(1) Keep the gap, for example 0.2 to 0.3mm, between bezel edge and T/P edge.

The reason is to avoid the bezel edge from contacting T/P surface that may cause “short” with bottom layer

(2) Insertion a cushion material is recommended.

(3) The cushion material should be limited on the busbar insulation paste area. If it is over the transparent insulation paste area, a “short” may be occurred.

(4) Do not to use an adhesive tape to bond it on the front of T/P and hang it to the housing bezel.

(5) Never expand the T/P top layer (PET Film) like a balloon by internal air pressure. The life of the T/P will extremely decreasing.

(6) Top layer, PET, dimension is changing base on environment temperature and humidity. Please avoid a stress from housing bezel to top layer, because it may cause “waving”.

(7) The input to the Touch Panel sometimes distorts touch panel itself.

(8) To use the stylus pen or fingernail sliding at the edge of the housing is prohibited. It would cause the cracking of the ITO coating and damage the touch panel. It also request not to press this area while assembling

(9) Purpose: In order to prevent accidental use and performance deterioration, please keep the following precautions.

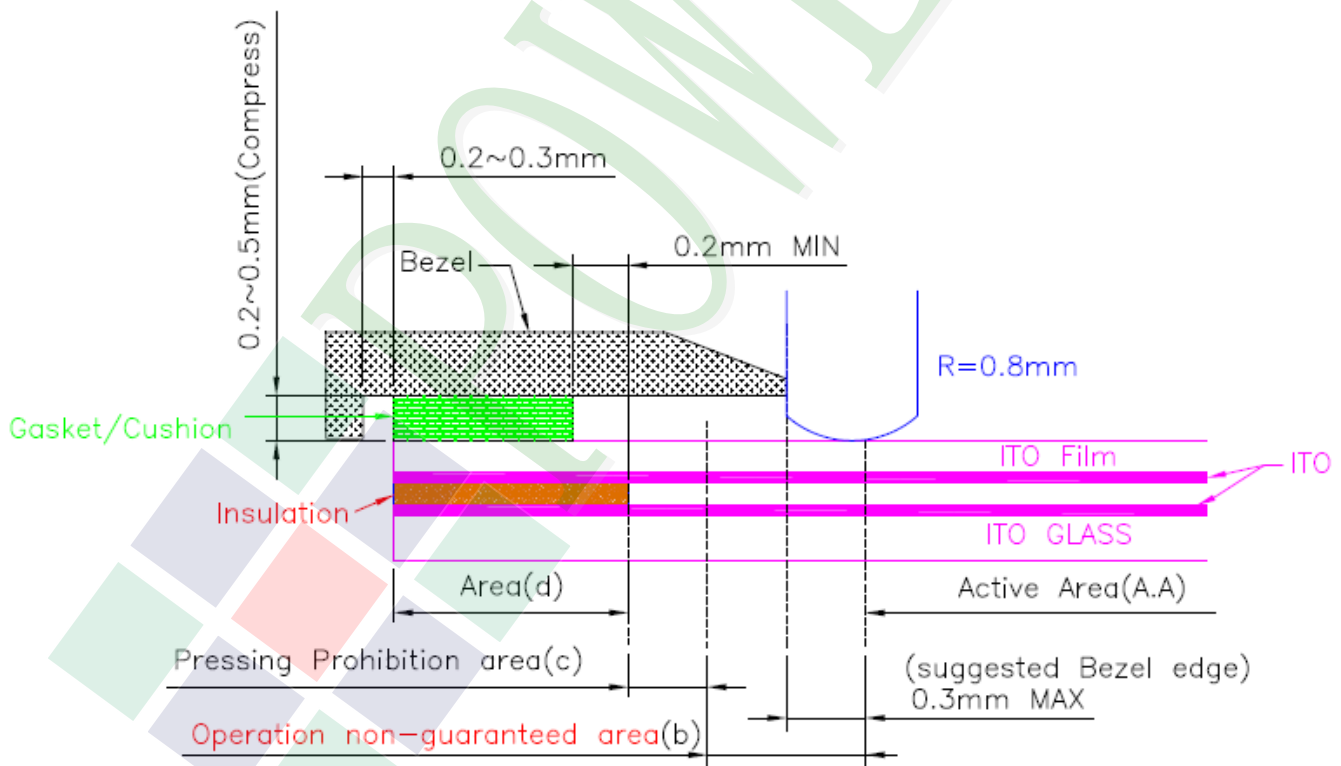

In order to prevent unusual performance degradation and malfunction of a touch panel, please carry out the set case designing and a touch panel assembling method after surely considering the definition of each area illustrated in above figure.

Area(a) : Active area

The active area is guaranteed the position data detectable precision, operation force and other operations. it is strongly recommended to place the operation button or menu keys within the active area. Due to structure, the active area is less durable at the edge or close to the edge.

Area(b) : Operation non-guaranteed area

This area does not guarantee a touch panel operation and its function. When this area is pressed, touch panel shows degradation of its performance and durability such as a pen sliding durability becomes about one-tenth compared with the active area (area-(a) as guaranteed area) and its operation force requires about double. About 0.5 mm outside from a boundary of the active area corresponds to this area.

Area(c) : Pressing prohibition area

The area which forbids pressing, because an excessive load is applied to a transparent electrode (ITO) and a serious damage is given to a touch panel function by pressing. About 0.5 mm outside from Operation non-guaranteed area .

Area(d) : Non-Active area

The area does not activate even if pressed.



2. MODULE STRUCTURE

2.1 Counter Drawing

2.1.1 LCM Mechanical Diagram

* See Appendix

2.1.2 Block Diagram

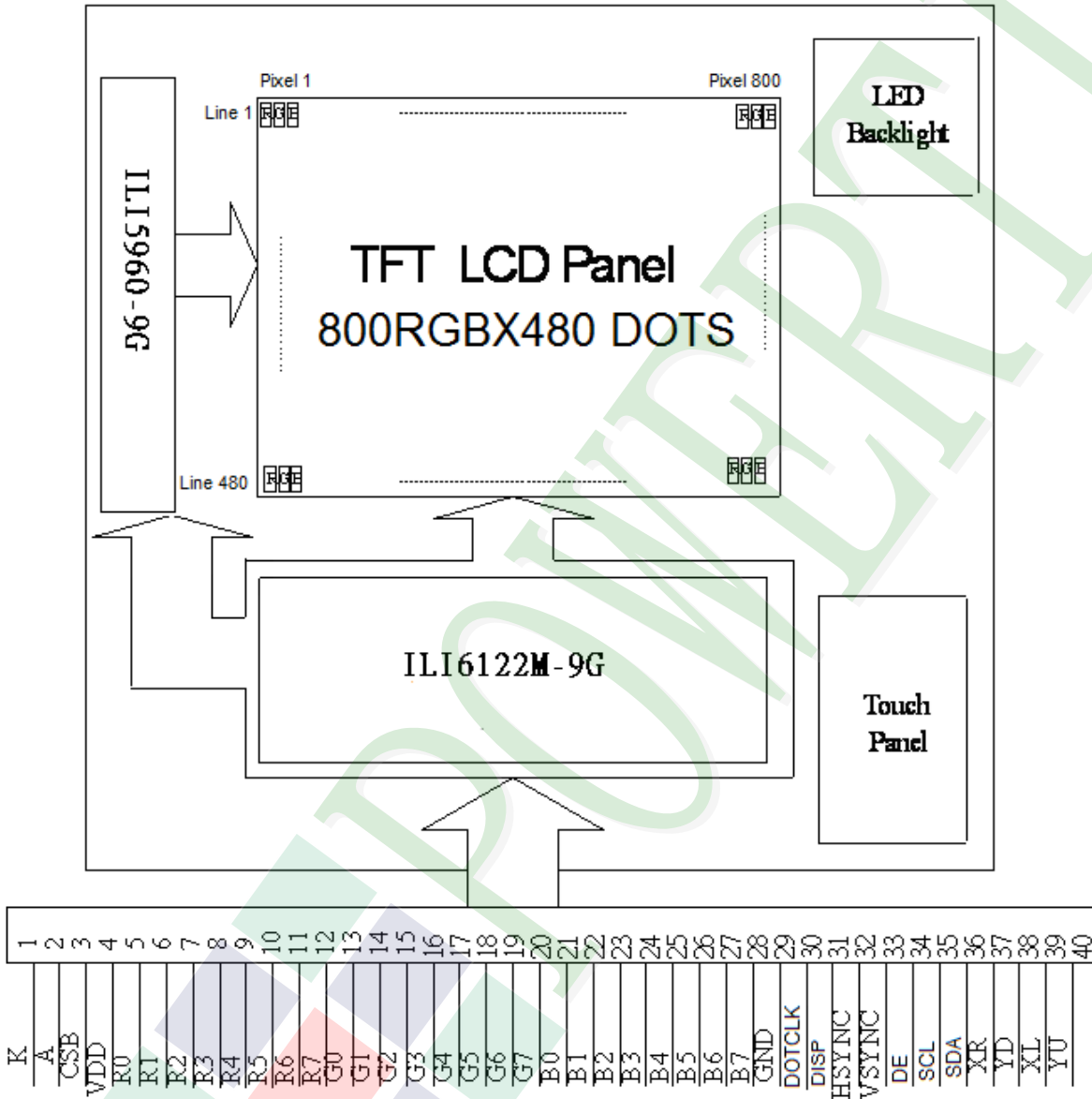

2.2 Interface Pin Description

Pin No.	Symbol	Function
1	LED-	Power supply for LED Backlight cathode input
2	LED+	Power supply for LED Backlight anode input
3	CS(NC)	Chip select pin of serial interface.
4	VDD	Digital power
5	R0	Red data bit 0
6	R1	Red data bit 1
7	R2	Red data bit 2
8	R3	Red data bit 3
9	R4	Red data bit 4
10	R5	Red data bit 5
11	R6	Red data bit 6
12	R7	Red data bit 7
13	G0	Green data bit 0
14	G1	Green data bit 1
15	G2	Green data bit 2
16	G3	Green data bit 3
17	G4	Green data bit 4
18	G5	Green data bit 5
19	G6	Green data bit 6
20	G7	Green data bit 7

Pin No.	Symbol	Function
21	B0	Blue data bit 0
22	B1	Blue data bit 1
23	B2	Blue data bit 2
24	B3	Blue data bit 3
25	B4	Blue data bit 4
26	B5	Blue data bit 5
27	B6	Blue data bit 6
28	B7	Blue data bit 7
29	GND	Ground
30	DOTCLK	Dot data clock, latching data at the rising edge
31	DISP	Display on/ off
32	HSYNC	Horizontal sync input
33	VSYNC	Vertical sync input
34	DE	Data enable
35	SCL(NC)	Data input and output in Serial communication/No connection when no using serial communication
36	SDA(NC)	Clock input in Serial communication / No connection when no using serial communication
37	XR	TP: X right
38	YD	TP: Y bottom
39	XL	TP: X left
40	YU	TP: Y top

2.3 Timing Characteristics

2.3.1 Vertical input timing

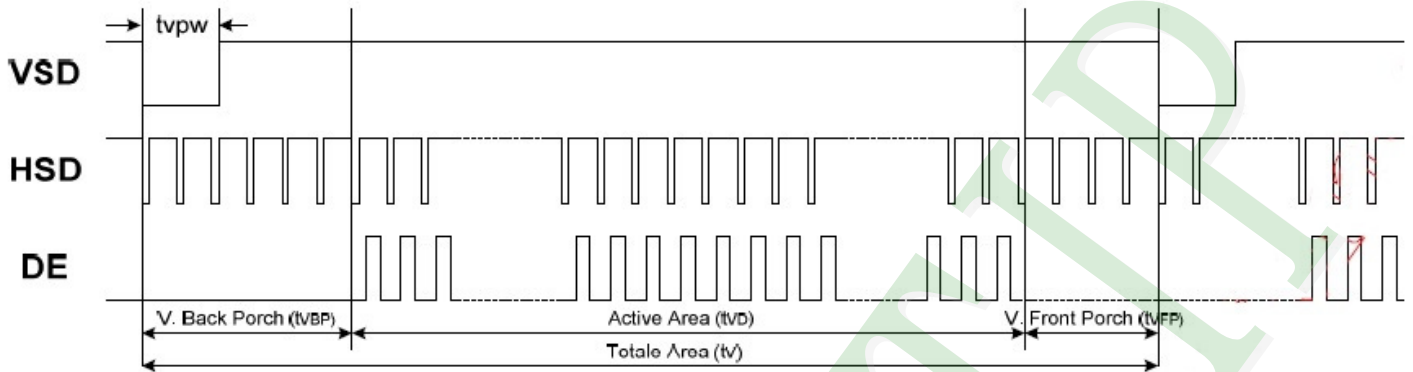

Parameter	Symbol	Value			Unit
		Min	Typ	Max	
Vertical display area	tvd		480		H
VSD period time	tv	510	525	650	H
VSD pulse width	tv_{pw}	1	-	20	H
VSD Back Porch(Blanking)	tv_b	23	23	23	H
VSD Front Proch	tv_{fb}	7	22	147	H

2.3.2 Horizontal input timing

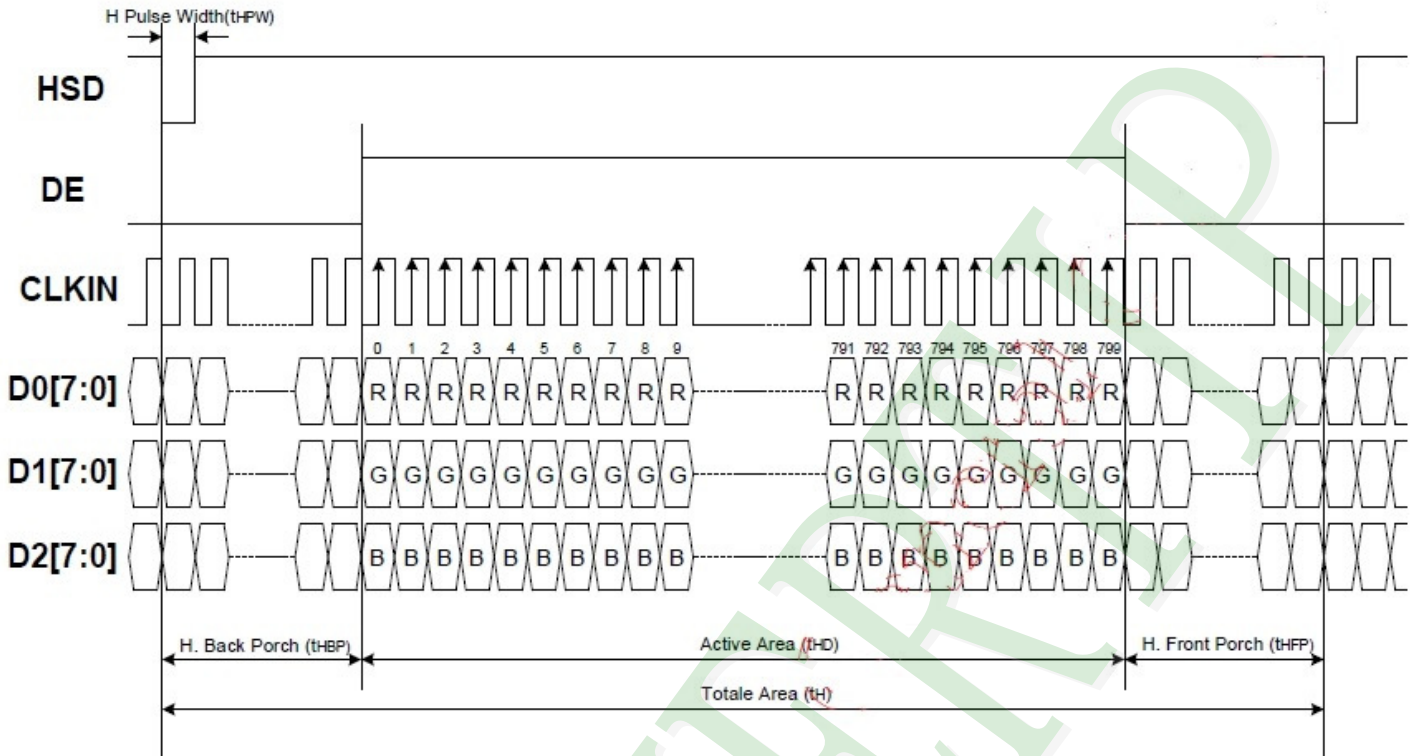

Parameter	Symbol	Value			Unit
		Min	Typ	Max	
Horizontal display area	thd		800		DCLK
DCLK frequency	fclk	-	33.3	50	MHz
1 Horizontal Line	th	862	1056	1200	DCLK
HSD pulse width	Min	-	1		
	Typ	-	-		
	Max	-	40		
HSD Back Porch (Blacking)	thp	46	46	46	
HSD Front Proch	thfb	16	210	354	

2.3.2 Input Clock and Data Timing

DE Mode

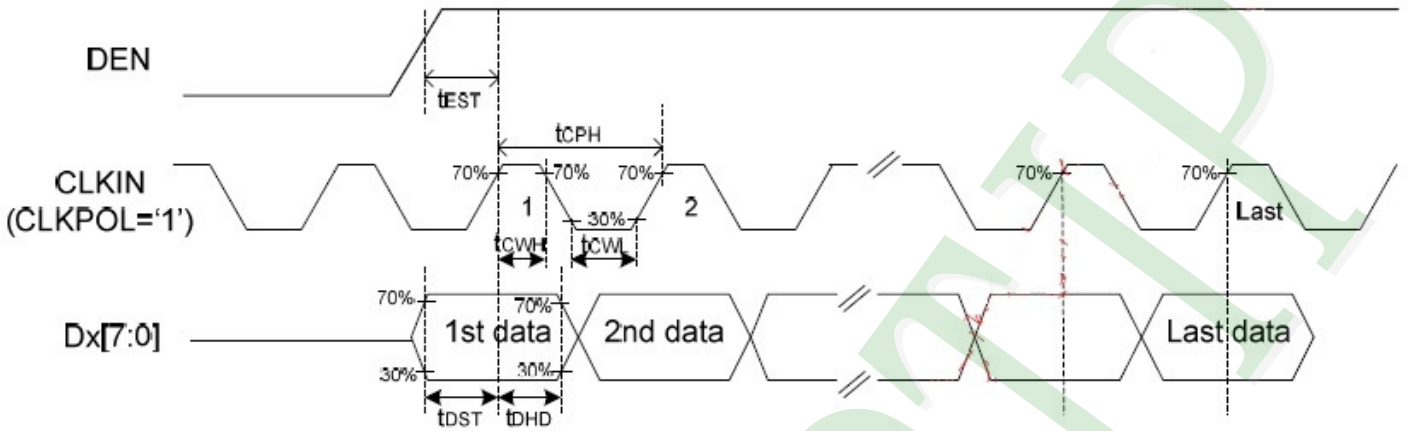

SYNC Mode

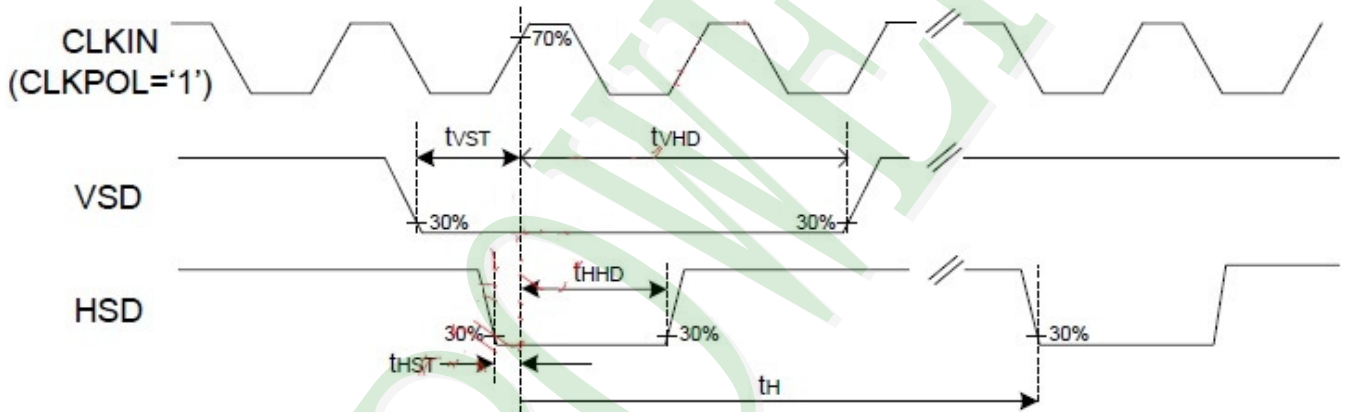

3. QUALITY ASSURANCE SYSTEM

3.1 Quality Assurance Flow Chart

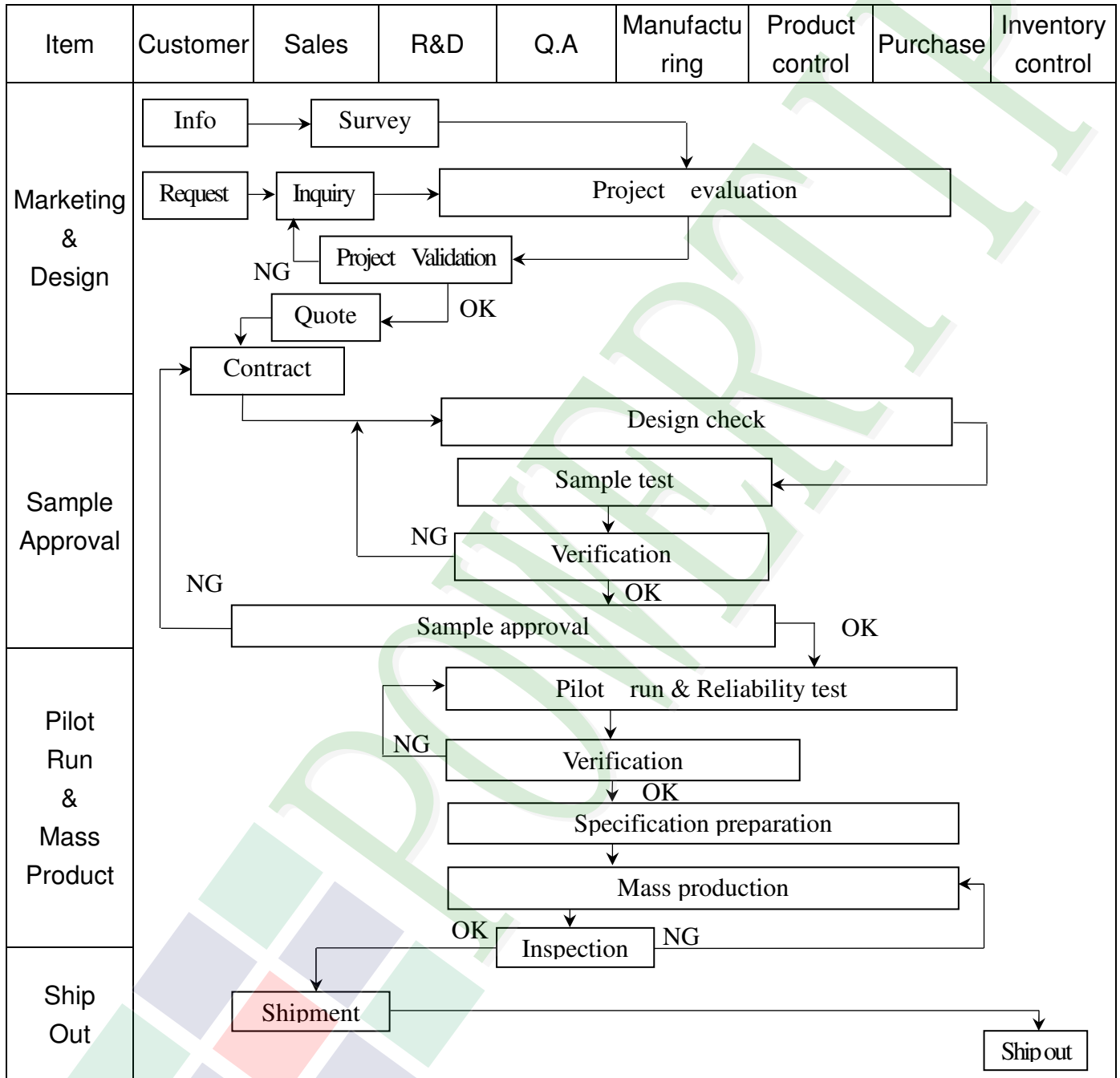

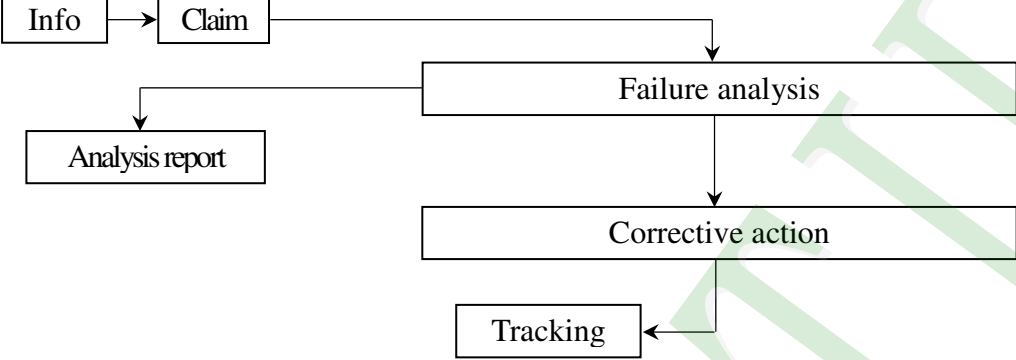
Item	Customer	Sales	R&D	Q.A	Manufacturing	Product control	Purchase	Inventory control
Sales Service	 <pre> graph TD Info[Info] --> Claim[Claim] Claim --> Failure[Failure analysis] Claim --> Report[Analysis report] Failure --> Action[Corrective action] Action --> Tracking[Tracking] </pre>							
Q.A Activity	1. ISO 9001 Maintenance Activities 3. Equipment calibration 5. Standardization Management				2. Process improvement proposal 4. Education And Training Activities			

3.2 Inspection Specification

- ◆Scope : The document shall be applied to TFT-LCD Module for 3.5" ~10" (Ver.B01).
- ◆Inspection Standard : MIL-STD-105E Table Normal Inspection Single Sampling Level II.
- ◆Equipment : Gauge 、 MIL-STD 、 Powertip Tester 、 Sample
- ◆Defect Level : Major Defect AQL : 0.4 ; Minor Defect AQL : 1.5
- ◆OUT Going Defect Level : Sampling.
- ◆Standard of the product appearance test :

a. Manner of appearance test :

- (1). The test best be under 20W×2 fluorescent light , and distance of view must be at 30 cm.
- (2). The test direction is base on about around 45° of vertical line.

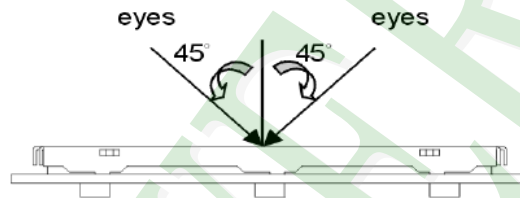

(3). Definition of area.

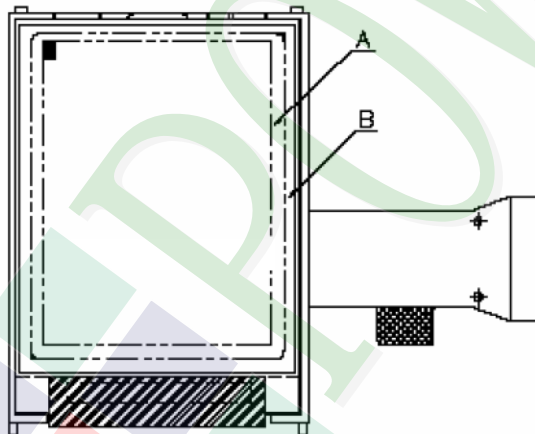

A area : viewing area

B area : Outside of viewing area

(4). Standard of inspection : (Unit : mm)



◆ Specification For TFT-LCD Module 3.5" ~10" :

(Ver.B01)

NO	Item	Criterion	Level										
01	Product condition	1. 1 The part number is inconsistent with work order of production.	Major										
		1. 2 Mixed product types.	Major										
		1. 3 Assembled in inverse direction.	Major										
02	Quantity	2. 1 The quantity is inconsistent with work order of production.	Major										
03	Outline dimension	3. 1 Product dimension and structure must conform to structure diagram.	Major										
04	Electrical Testing	4. 1 Missing line character and icon.	Major										
		4. 2 No function or no display.	Major										
		4. 3 Display malfunction.	Major										
		4. 4 LCD viewing angle defect.	Major										
		4. 5 Current consumption exceeds product specifications.	Major										
05	Dot defect (Bright dot 、 Dark dot) On -display	<table border="1"> <thead> <tr> <th>Item</th> <th>Acceptance (Q'ty)</th> </tr> </thead> <tbody> <tr> <td>Bright Dot</td> <td>≤ 4</td> </tr> <tr> <td>Dark Dot</td> <td>≤ 5</td> </tr> <tr> <td>Joint Dot</td> <td>≤ 3</td> </tr> <tr> <td>Total</td> <td>≤ 7</td> </tr> </tbody> </table>	Item	Acceptance (Q'ty)	Bright Dot	≤ 4	Dark Dot	≤ 5	Joint Dot	≤ 3	Total	≤ 7	Minor
		Item	Acceptance (Q'ty)										
		Bright Dot	≤ 4										
		Dark Dot	≤ 5										
		Joint Dot	≤ 3										
Total	≤ 7												
5. 1 Inspection pattern : full white , full black , Red , Green and blue screens.													
5. 2 It is defined as dot defect if defect area $> 1/2$ dot.													
5. 3 The distance between two dot defect ≥ 5 mm.													



◆ Specification For TFT-LCD Module 3.5" ~10" :

(Ver.B01)

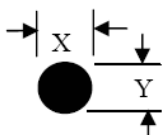
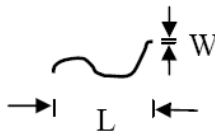
NO	Item	Criterion	Level																																								
06	<p>Black or white dot、scratch、contamination</p> <p>Round type</p>  <p>$\Phi = (x+y) / 2$</p> <p>Line type</p> 	<p>6.1 Round type (Non-display or display) :</p> <table border="1"> <thead> <tr> <th rowspan="2">Dimension (diameter : Φ)</th> <th colspan="2">Acceptance (Q'ty)</th> </tr> <tr> <th>A area</th> <th>B area</th> </tr> </thead> <tbody> <tr> <td>$\Phi \leq 0.25$</td> <td colspan="2">Ignore</td> </tr> <tr> <td>$0.25 < \Phi \leq 0.50$</td> <td>5</td> <td rowspan="3">Ignore</td> </tr> <tr> <td>$\Phi > 0.50$</td> <td>0</td> </tr> <tr> <td>Total</td> <td>5</td> </tr> </tbody> </table> <p>6.2 Line type(Non-display or display) :</p> <table border="1"> <thead> <tr> <th rowspan="2">Length (L)</th> <th rowspan="2">Width (W)</th> <th colspan="2">Acceptance (Q'ty)</th> </tr> <tr> <th>A area</th> <th>B area</th> </tr> </thead> <tbody> <tr> <td>--</td> <td>$W \leq 0.03$</td> <td colspan="2">Ignore</td> </tr> <tr> <td>$L \leq 10.0$</td> <td>$0.03 < W \leq 0.05$</td> <td>4</td> <td rowspan="3">Ignore</td> </tr> <tr> <td>$L \leq 5.0$</td> <td>$0.05 < W \leq 0.10$</td> <td>2</td> </tr> <tr> <td>--</td> <td>$W > 0.10$</td> <td colspan="2">As round type</td> </tr> <tr> <td colspan="2">Total</td> <td>5</td> <td></td> </tr> </tbody> </table>	Dimension (diameter : Φ)	Acceptance (Q'ty)		A area	B area	$\Phi \leq 0.25$	Ignore		$0.25 < \Phi \leq 0.50$	5	Ignore	$\Phi > 0.50$	0	Total	5	Length (L)	Width (W)	Acceptance (Q'ty)		A area	B area	--	$W \leq 0.03$	Ignore		$L \leq 10.0$	$0.03 < W \leq 0.05$	4	Ignore	$L \leq 5.0$	$0.05 < W \leq 0.10$	2	--	$W > 0.10$	As round type		Total		5		Minor
Dimension (diameter : Φ)	Acceptance (Q'ty)																																										
	A area	B area																																									
$\Phi \leq 0.25$	Ignore																																										
$0.25 < \Phi \leq 0.50$	5	Ignore																																									
$\Phi > 0.50$	0																																										
Total	5																																										
Length (L)	Width (W)	Acceptance (Q'ty)																																									
		A area	B area																																								
--	$W \leq 0.03$	Ignore																																									
$L \leq 10.0$	$0.03 < W \leq 0.05$	4	Ignore																																								
$L \leq 5.0$	$0.05 < W \leq 0.10$	2																																									
--	$W > 0.10$	As round type																																									
Total		5																																									
07	<p>Polarizer Bubble</p>	<table border="1"> <thead> <tr> <th rowspan="2">Dimension (diameter : Φ)</th> <th colspan="2">Acceptance (Q'ty)</th> </tr> <tr> <th>A area</th> <th>B area</th> </tr> </thead> <tbody> <tr> <td>$\Phi \leq 0.25$</td> <td colspan="2">Ignore</td> </tr> <tr> <td>$0.25 < \Phi \leq 0.50$</td> <td>4</td> <td rowspan="3">Ignore</td> </tr> <tr> <td>$0.50 < \Phi \leq 0.80$</td> <td>1</td> </tr> <tr> <td>$\Phi > 0.80$</td> <td>0</td> </tr> <tr> <td>Total</td> <td>5</td> <td></td> </tr> </tbody> </table>	Dimension (diameter : Φ)	Acceptance (Q'ty)		A area	B area	$\Phi \leq 0.25$	Ignore		$0.25 < \Phi \leq 0.50$	4	Ignore	$0.50 < \Phi \leq 0.80$	1	$\Phi > 0.80$	0	Total	5		Minor																						
Dimension (diameter : Φ)	Acceptance (Q'ty)																																										
	A area	B area																																									
$\Phi \leq 0.25$	Ignore																																										
$0.25 < \Phi \leq 0.50$	4	Ignore																																									
$0.50 < \Phi \leq 0.80$	1																																										
$\Phi > 0.80$	0																																										
Total	5																																										

◆Specification For TFT-LCD Module 3.5" ~10" :

(Ver.B01)

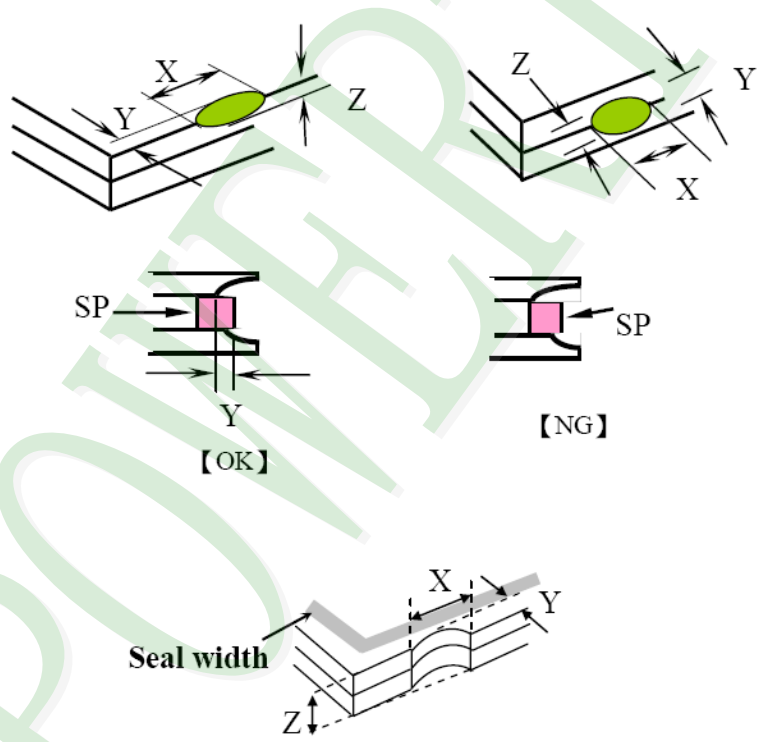
NO	Item	Criterion	Level									
08	The crack of glass	<p>Symbols :</p> <p>X : The length of crack Z : The thickness of crack t : The thickness of glass</p> <p>Y : The width of crack. W : terminal length a : LCD side length</p> <hr/> <p>8.1 General glass chip : 8.1.1 Chip on panel surface and crack between panels:</p>  <table border="1" data-bbox="542 1545 1340 1836"> <thead> <tr> <th>X</th> <th>Y</th> <th>Z</th> </tr> </thead> <tbody> <tr> <td>$\leq a$</td> <td>Crack can't enter viewing area</td> <td>$\leq 1/2 t$</td> </tr> <tr> <td>$\leq a$</td> <td>Crack can't exceed the half of SP width.</td> <td>$1/2 t < Z \leq 2 t$</td> </tr> </tbody> </table>	X	Y	Z	$\leq a$	Crack can't enter viewing area	$\leq 1/2 t$	$\leq a$	Crack can't exceed the half of SP width.	$1/2 t < Z \leq 2 t$	Minor
X	Y	Z										
$\leq a$	Crack can't enter viewing area	$\leq 1/2 t$										
$\leq a$	Crack can't exceed the half of SP width.	$1/2 t < Z \leq 2 t$										

◆ Specification For TFT-LCD Module 3.5" ~10" :

(Ver.B01)

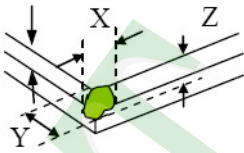
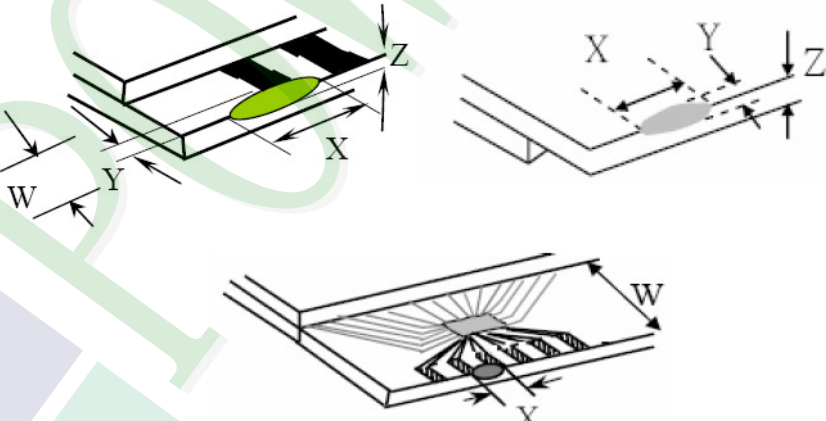
NO	Item	Criterion	Level												
08	The crack of glass	<p>Symbols :</p> <p>X : The length of crack Z : The thickness of crack t : The thickness of glass</p> <p>Y : The width of crack. W : terminal length a : LCD side length</p> <hr/> <p>8.1.2 Corner crack :</p>  <table border="1" data-bbox="523 757 1332 1048"> <thead> <tr> <th>X</th> <th>Y</th> <th>Z</th> </tr> </thead> <tbody> <tr> <td>$\leq 1/5 a$</td> <td>Crack can't enter viewing area</td> <td>$Z \leq 1/2 t$</td> </tr> <tr> <td>$\leq 1/5 a$</td> <td>Crack can't exceed the half of SP width.</td> <td>$1/2 t < Z \leq 2 t$</td> </tr> </tbody> </table>	X	Y	Z	$\leq 1/5 a$	Crack can't enter viewing area	$Z \leq 1/2 t$	$\leq 1/5 a$	Crack can't exceed the half of SP width.	$1/2 t < Z \leq 2 t$				
		X	Y	Z											
$\leq 1/5 a$	Crack can't enter viewing area	$Z \leq 1/2 t$													
$\leq 1/5 a$	Crack can't exceed the half of SP width.	$1/2 t < Z \leq 2 t$													
		<p>8.2 Protrusion over terminal :</p> <p>8.2.1 Chip on electrode pad :</p>  <table border="1" data-bbox="561 1675 1342 1848"> <thead> <tr> <th></th> <th>X</th> <th>Y</th> <th>Z</th> </tr> </thead> <tbody> <tr> <td>Front</td> <td>$\leq a$</td> <td>$\leq 1/2 W$</td> <td>$\leq t$</td> </tr> <tr> <td>Back</td> <td>$\leq a$</td> <td>$\leq W$</td> <td>$\leq 1/2 t$</td> </tr> </tbody> </table>		X	Y	Z	Front	$\leq a$	$\leq 1/2 W$	$\leq t$	Back	$\leq a$	$\leq W$	$\leq 1/2 t$	Minor
	X	Y	Z												
Front	$\leq a$	$\leq 1/2 W$	$\leq t$												
Back	$\leq a$	$\leq W$	$\leq 1/2 t$												

◆ Specification For TFT-LCD Module 3.5" ~10" :

(Ver.B01)

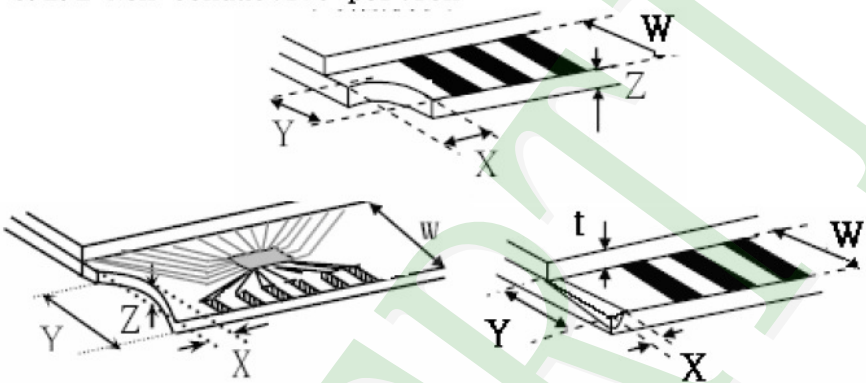
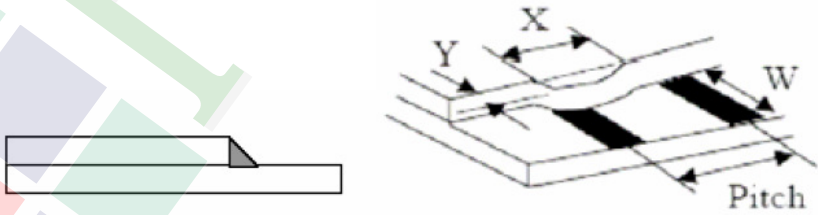
NO	Item	Criterion	Level						
08	The crack of glass	<p>Symbols :</p> <p>X : The length of crack Y : The width of crack. Z : The thickness of crack W : terminal length t : The thickness of glass a : LCD side length</p> <hr/> <p>8.2.2 Non-conductive portion :</p>  <table border="1" data-bbox="630 963 1260 1120"> <thead> <tr> <th>X</th> <th>Y</th> <th>Z</th> </tr> </thead> <tbody> <tr> <td>$\leq 1/3 a$</td> <td>$\leq W$</td> <td>$\leq t$</td> </tr> </tbody> </table> <p>⊙ If the chipped area touches the ITO terminal, over 2/3 of the ITO must remain and be inspected according to electrode terminal specifications.</p>	X	Y	Z	$\leq 1/3 a$	$\leq W$	$\leq t$	Minor
		X	Y	Z					
$\leq 1/3 a$	$\leq W$	$\leq t$							
<p>8.2.3 Glass remain :</p>  <table border="1" data-bbox="550 1736 1244 1881"> <thead> <tr> <th>X</th> <th>Y</th> <th>Z</th> </tr> </thead> <tbody> <tr> <td>$\leq a$</td> <td>$\leq 1/3 W$</td> <td>$\leq t$</td> </tr> </tbody> </table>	X	Y	Z	$\leq a$	$\leq 1/3 W$	$\leq t$			
X	Y	Z							
$\leq a$	$\leq 1/3 W$	$\leq t$							

◆Specification For TFT-LCD Module 3.5" ~10" :

(Ver.B01)

NO	Item	Criterion	Level
09	Backlight elements	9. 1 Backlight can't work normally.	Major
		9. 2 Backlight doesn't light or color is wrong.	Major
		9. 3 Illumination source flickers when lit.	Major
10	General appearance	10. 1 Pin type 、 quantity 、 dimension must match type in structure diagram.	Major
		10. 2 No short circuits in components on PCB or FPC .	Major
		10. 3 Parts on PCB or FPC must be the same as on the production characteristic chart .There should be no wrong parts , missing parts or excess parts.	Major
		10. 4 Product packaging must the same as specified on packaging specification sheet.	Minor
		10. 5 The folding and peeled off in polarizer are not acceptable.	Minor
		10. 6 The PCB or FPC between B/L assembled distance(PCB or FPC) is ≤ 1.5 mm.	Minor

4. RELIABILITY TEST

4.1 Reliability Test Condition

(Ver.B01)

NO.	TEST ITEM	TEST CONDITION										
1	High Temperature Storage Test	Keep in +80 ±2°C 96 hrs Surrounding temperature, then storage at normal condition 4hrs.										
2	Low Temperature Storage Test	Keep in -30 ±2°C 96 hrs Surrounding temperature, then storage at normal condition 4hrs.										
3	High Temperature / High Humidity Storage Test	Keep in +60 °C / 90% R.H duration for 96 hrs Surrounding temperature, then storage at normal condition 4hrs. (Excluding the polarizer)										
4	Temperature Cycling Storage Test	<p style="text-align: center;"> $-30^{\circ}\text{C} \rightarrow +25^{\circ}\text{C} \rightarrow +80^{\circ}\text{C} \rightarrow +25^{\circ}\text{C}$ (30mins) (5mins) (30mins) (5mins) $\longleftarrow \hspace{10em} \longrightarrow$ 10 Cycle </p> <p>Surrounding temperature, then storage at normal condition 4hrs.</p>										
5	ESD Test	Air Discharge: Apply 2 KV with 5 times Discharge for each polarity +/-										
		Contact Discharge: Apply 250 V with 5 times discharge for each polarity +/-										
		<ol style="list-style-type: none"> 1. Temperature ambience : 15°C ~ 35°C 2. Humidity relative : 30% ~ 60% 3. Energy Storage Capacitance(Cs+Cd) : 150pF±10% 4. Discharge Resistance(Rd) : 330Ω±10% 5. Discharge, mode of operation : Single Discharge (time between successive discharges at least 1 sec) (Tolerance if the output voltage indication : ±5%) 										
6	Vibration Test (Packaged)	<ol style="list-style-type: none"> 1. Sine wave 10~55 Hz frequency (1 min/sweep) 2. The amplitude of vibration : 1.5 mm 3. Each direction (X、Y、Z) duration for 2 Hrs 										
7	Drop Test (Packaged)	<table border="1" style="width: 100%; text-align: center;"> <thead> <tr> <th>Packing Weight (Kg)</th> <th>Drop Height (cm)</th> </tr> </thead> <tbody> <tr> <td>0 ~ 45.4</td> <td>122</td> </tr> <tr> <td>45.4 ~ 90.8</td> <td>76</td> </tr> <tr> <td>90.8 ~ 454</td> <td>61</td> </tr> <tr> <td>Over 454</td> <td>46</td> </tr> </tbody> </table>	Packing Weight (Kg)	Drop Height (cm)	0 ~ 45.4	122	45.4 ~ 90.8	76	90.8 ~ 454	61	Over 454	46
		Packing Weight (Kg)	Drop Height (cm)									
0 ~ 45.4	122											
45.4 ~ 90.8	76											
90.8 ~ 454	61											
Over 454	46											
		Drop Direction : ※1 corner / 3 edges / 6 sides each 1time										

5. PRECAUTION RELATING PRODUCT HANDLING

5.1 SAFETY

- 5.1.1 If the LCD panel breaks , be careful not to get the liquid crystal to touch your skin.
- 5.1.2 If the liquid crystal touches your skin or clothes , please wash it off immediately by using soap and water.

5.2 HANDLING

- 5.2.1 Avoid any strong mechanical shock which can break the glass.
- 5.2.2 Avoid static electricity which can damage the CMOS LSI—When working with the module , be sure to ground your body and any electrical equipment you may be using.
- 5.2.3 Do not remove the panel or frame from the module.
- 5.2.4 The polarizing plate of the display is very fragile. So , please handle it very carefully ,do not touch , push or rub the exposed polarizing with anything harder than an HB pencil lead (glass , tweezers , etc.)
- 5.2.5 Do not wipe the polarizing plate with a dry cloth , as it may easily scratch the surface of plate.
- 5.2.6 Do not touch the display area with bare hands , this will stain the display area.
- 5.2.7 Do not use ketonics solvent & aromatic solvent. Use with a soft cloth soaked with a cleaning naphtha solvent.
- 5.2.8 To control temperature and time of soldering is $320\pm 10^{\circ}\text{C}$ and 3-5 sec.
- 5.2.9 To avoid liquid (include organic solvent) stained on LCM .

5.3 STORAGE

- 5.3.1 Store the panel or module in a dark place where the temperature is $25^{\circ}\text{C} \pm 5^{\circ}\text{C}$ and the humidity is below 65% RH.
- 5.3.2 Do not place the module near organics solvents or corrosive gases.
- 5.3.3 Do not crush , shake , or jolt the module.

5.4 TERMS OF WARRANTY

- 5.4.1 Applicable warrant period
The period is within thirteen months since the date of shipping out under normal using and storage conditions.
- 5.4.2 Unaccepted responsibility
This product has been manufactured to your company's specification as a part for use in your company's general electronic products. It is guaranteed to perform according to delivery specifications. For any other use apart from general electronic equipment , we cannot take responsibility if the product is used in nuclear power control equipment , aerospace equipment , fire and security systems or any other applications in which there is a direct risk to human life and where extremely high levels of reliability are required.

A B C D E F G H

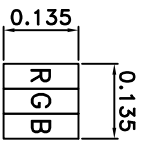
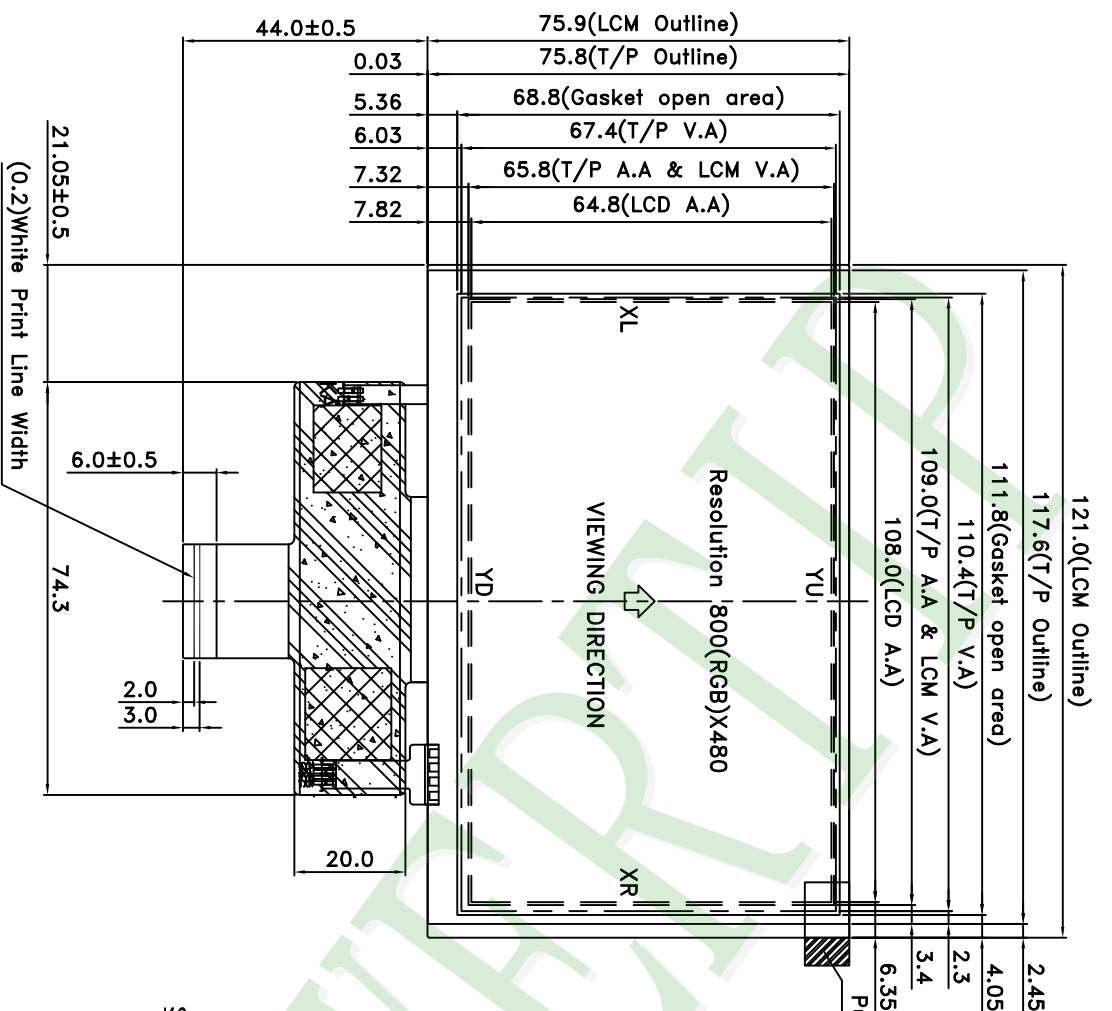

NOTES:

1. LCD TYPE: a-si TFT
2. LCD DISPLAY: POSITIVE/TRANSMISSIVE
3. VIEW DIRECTION: 6 O'CLOCK
4. The tolerance unless classified ±0.3mm
5. Shielding tape, Unbending area.
6. FPC suggested connector: "Hirose" FH34SRJ-40S-0.5SH(50)" or compatible.
7. Recommended Housing open window should be less than Module V.A

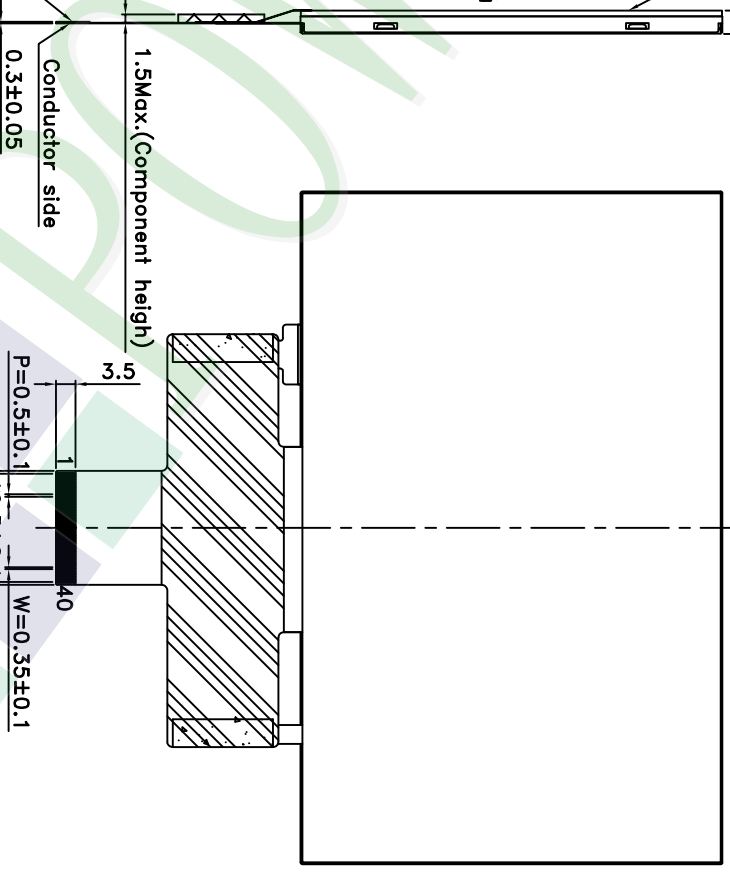

007					
006					
005					
004					
003					
002					
001	NEW DRAWING	Eva	2016/01/11		
REV	REV BY	REVISER	DATE		

PART NO:		PH800480T024-IDB01
DRAWING NAME:		LMD-PH800480T024-IDB01
TITLE:		LCD MODULE DRAWING

Design	Eva Liao
Check	Tina Chen
Approve	Linda Lee

久正光電股份有限公司
POWER TIP TECHNOLOGY CORPORATION

Unit	MM	Surface	(3)
Scale	FIT	Material	
Page	1/1	Thickness	
Quantity			

Tolerance (mm)		Precision Level
1 ~ 4		-
4 ~ 16		-
16 ~ 63		-
63 ~ 250		-
250 ~ 1000		-

LCM包裝規格書

LCM Packaging Specifications (For Tray)

Approve	Check	Contact
Linda	Tina	Eva

1. 包裝材料規格表 (Packaging Material) : (per carton)

No.	Item	Model	Dimensions (mm)	1Pcs Weight	Quantity	Total Weight
1	成品 (LCM)	PH800480T024-IDB01	121.0 X 75.9	0.0801	144	11.5344
2	多層薄膜(1)POF	OTFILM0BA03ABA	19"X350X0.015	—	6	—
3	TRAY 盤 (2)Tray	TY00000000308	352 X 260 X 12.8	0.0965	42	4.053
4	舒美墊(3) EPE	FOAM000000047	350 X 255 X 5	0.011	6	0.066
5	內盒(4)Product Box	BX36627063ABBA	383 X 270 X 66	0.182	6	1.092
6	保利龍板(5)Polylon board	OTPLB00PL08ABA	550 X 393 X 20	0.0284	2	0.0568
7	外紙箱(6)Carton	BX57041027CCBA	570 X 410 X 265	1.0	1	1.0
8						
9						

2. 一整箱總重量 (Total LCD Weight in carton) : 17.8 Kg±10%

3. 單箱數量規格表 (Packaging Specifications and Quantity) :

(1) LCM quantity per box : no per tray	4	x no of tray	6	=	24
(2) Total LCM quantity in carton : quantity per box	24	x no of boxes	6	=	144

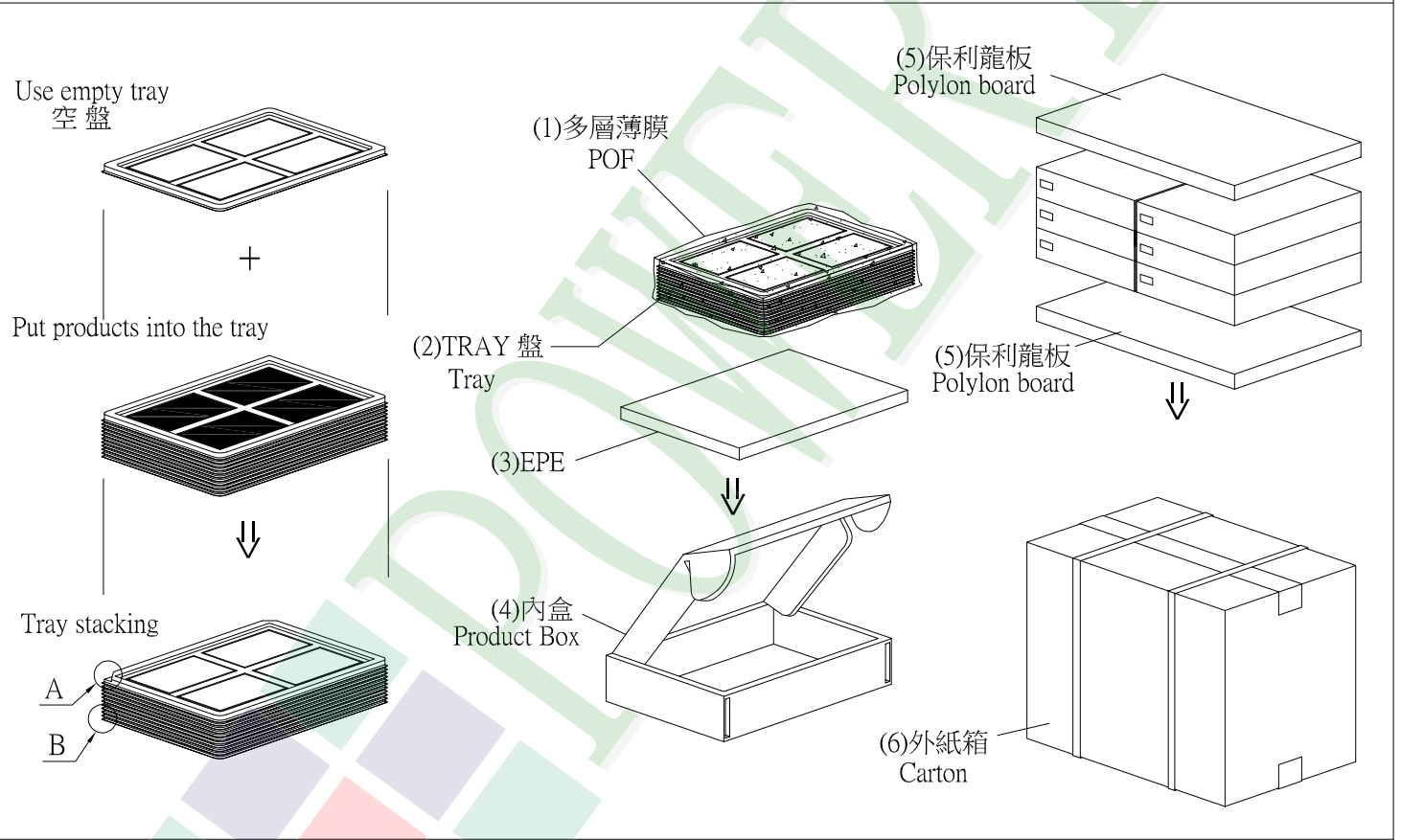

特 記 事 項 (REMARK)

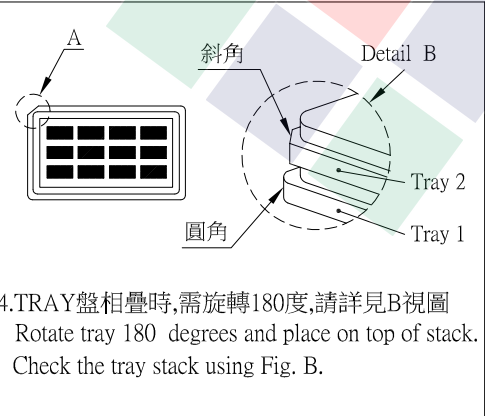

4. TRAY盤相疊時,需旋轉180度,請詳見B視圖
Rotate tray 180 degrees and place on top of stack.
Check the tray stack using Fig. B.