

TWN4 USB Front Reader LEGIC

Multi-frequency RFID reader (LF/HF) with NFC and BLE support



TWN4 USB Front Reader LEGIC
(exemplary illustrations)

The devices of the TWN4 USB Front Reader family are an excellent solution for any RFID-based applications that require a direct and simple connection per USB. All readers are available with an NXP or LEGIC frontend and support RFID, NFC and Bluetooth Low Energy (BLE) technologies. In addition, the patented USB connector on the rear side can be turned to 90°, which enables a quick and easy installation into any host system equipped with a USB port. Thanks to their compact form and enhanced read/write performance, the readers are particularly appropriate as a secure printing solution, but also for Single-Sign on and healthcare applications.

Key features of the TWN4 USB Front Reader LEGIC include a USB hub on the front side that can be deactivated via device driver, a powerful SDK for writing apps that are executed directly on the reader and an integrated BLE module. Additionally, the reader can read more than 60 RFID technologies from low (LF) and high frequency (HF) bands, including NFC. This gives the option to select as many of the technologies required instead of being forced to select just a few ones.

Special features:

- + Possibility to read more than 60 RFID technologies
- + Two RFID frequencies (125 kHz/13.56 MHz) with NFC and BLE support
- + Patented USB connector on the rear side can be rotated to 90°
- + USB hub “pass through” on the front side can be deactivated via device driver
- + Powerful SDK for writing apps which are executed directly on the reader
- + Firmware update in the field possible
- + Available with custom inlay and packaging as “ready to sell from stock”
- + Supports transparent data exchange with RFID media
- + CCID and PC/SC 2.01



Elevator



EV Chargers



Access



Shop POS



Fitness
Equipment



Ticket POS



PC Log-on



Document
Management



Driver ID



Vending



Parking



Gaming



Locker Locks



Time
Attendance



Industrial
PC

TECHNICAL DATA

FREQUENCIES	125 kHz (LF) / 13.56 MHz (HF) / 2.4 GHz (BLE)
ANTENNAS	Integrated
HOUSING	Material: ABS UL94-V0 Color: black
DIMENSIONS (L X W X H)	Approx. 60.00 x 39.00 x 16.50 mm / 2.36 x 1.54 x 0.65 inch
POWER	USB: 4.3 V – 5.5 V ES1/PS2 classified power source according to IEC 62368-1, short-circuit current < 8 A
CURRENT CONSUMPTION	RF field on: 260 mA typically + 16 mA (BLE)
TEMPERATURE RANGE	Operating: 0 °C up to +65 °C (+32 °F up to +149 °F) Storage: -40 °C up to +70 °C (-40 °F up to +158 °F)
RELATIVE HUMIDITY	5% to 95% non-condensing
READ/WRITE DISTANCE	LF and HF: up to 51 mm / 2 inch, depending on environment and transponder
OPERATING MODES (USB)	USB keyboard emulation – USB virtual COM port – CCID / PC/SC 2.01
BLUETOOTH LOW ENERGY	BLE version 4.1 (upgradable to 4.2)
MTBF	500,000 hours
WEIGHT	Approx. 22 g / 0.78 oz
SUPPORTED OPTIONS AND TRANSPONDERS	Depending on the firmware version and installed options, ELATEC readers and modules can support a wide range of RFID technologies. Please refer to the relevant ELATEC transponder matrix (available at www.elatec-rfid.com/int/transponder-technology) for more information about the available options and RFID technologies supported by the product.
OS SUPPORT	Windows 7 (32-/64-bit) and higher versions, Linux, Android ¹⁾ , iOS ¹⁾ , MAC OS X ¹⁾
PERIPHERAL INTERFACES	USB (male), type A USB (female), type A 1 SAM slot for ID-000 card format
TRANSMISSION SPEED	Host: USB full speed (12 Mbit/s), USB hub: USB Hi-Speed up to 40 Mbit/s, HF Air: up to 848 kbit/s, BLE Air: up to 100 kbit/s
CERTIFICATION NAME	TWN4 USB Front Reader LEGIC
CERTIFICATIONS	Non-exhaustive list ²⁾ : CE/RED, FCC, IC, TAA compliant, REACH and RoHS-III compliant
ORDER CODES	T4FK-BBFRLM7 Kit including standard reader T4FK-BBFRLM7-P Kit including reader with P option

¹⁾On request

²⁾The product has been certified for use in many countries and regions. Contact your Sales representative for detailed information about all certifications and approvals granted to the product.

TECHNICAL DRAWINGS

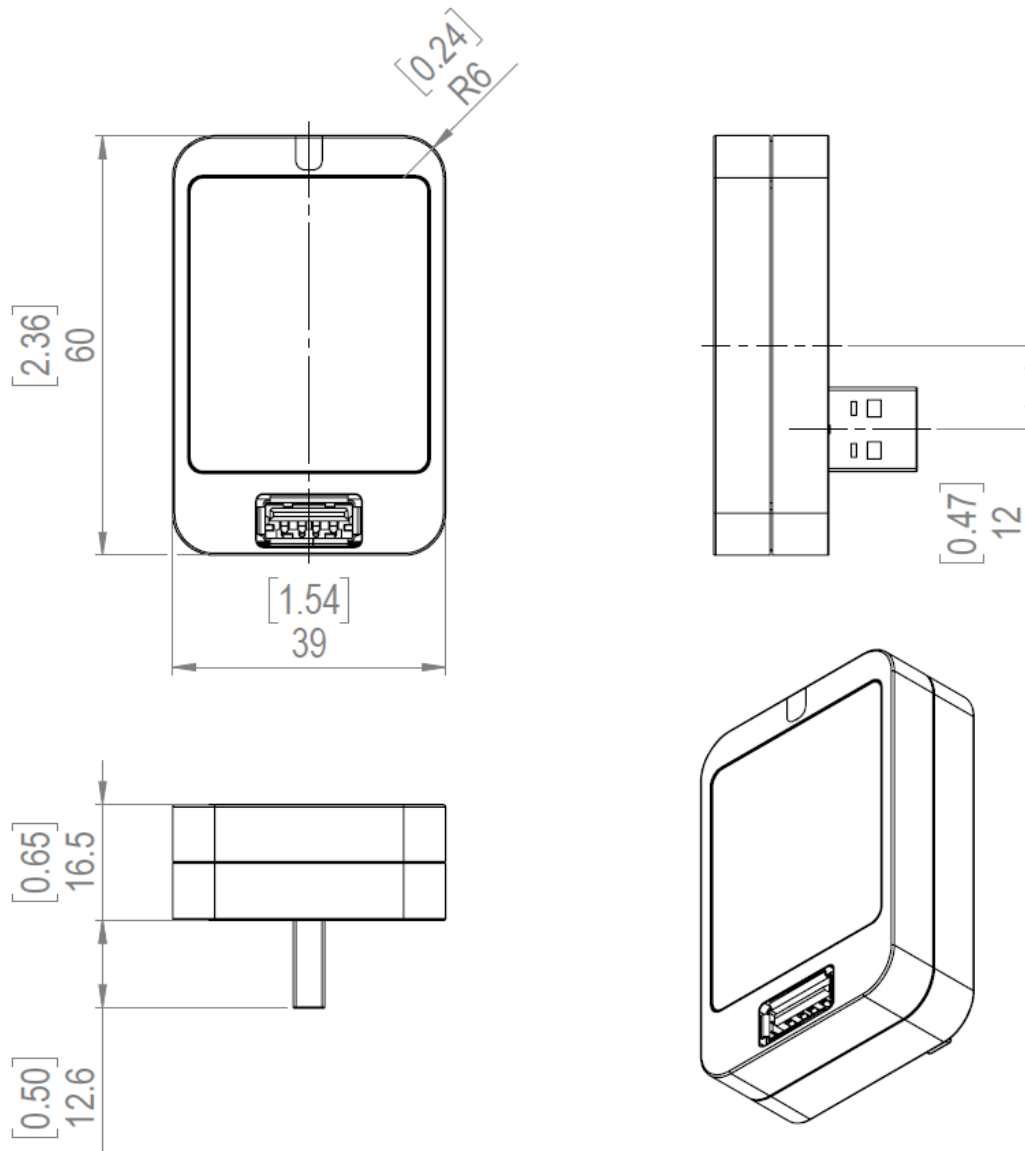

All measures in mm [inch]

HQ / EUROPE

ELATEC GmbH
 Zeppelinstraße 1
 82178 Puchheim, Germany
 P +49 89 552 9961 0
 F +49 89 552 9961 129
 info-rfid@elatec.com

AMERICAS

ELATEC Inc.
 1995 SW Martin Hwy.
 Palm City, FL 34990, USA
 P +1 772 210 2263
 F +1 772 382 3749
 americas-info@elatec.com

APAC

ELATEC Singapore
 1 Scotts Road #21-10 Shaw
 Centre, Singapore 228208
 P +65 9670 4348
 apac-info@elatec.com

MIDDLE EAST

ELATEC Middle East
 Trading FZE
 P.O. Box 16868, Dubai, UAE
 P +971 50 9322691
 middle-east-info@elatec.com

elatec.com

ELATEC reserves the right to change any information or data in this document without prior notice. ELATEC declines all responsibility for the use of this product with any other specification but the one mentioned above. Any additional requirement for a specific customer application has to be validated by the customer themselves at their own responsibility. Where application information is given, it is only advisory and does not form part of the specification. Disclaimer: All names used in this document are registered trademarks of their respective owners.